

ITEM 091312 NZ1HS-511-MC1833

Description	Technical data	Accessories	Downloads
-------------	----------------	-------------	-----------



Features

- › Steel roller \varnothing 19 mm
- › With grooved ball bearing
- › Cable entry M20 x 1.5

Approach direction

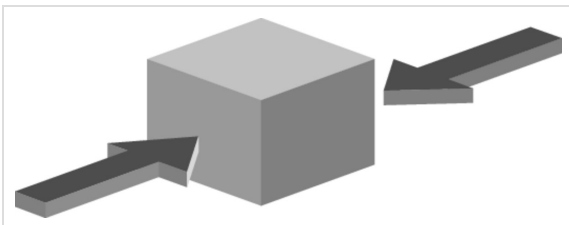

› Figure
Horizontal

Switching direction

- › Right, left or both sides

Switching element

Approvals



Mechanical values and environment

Housing material	Anodized die-cast alloy
Weight	Net 0,3 kg
Ambient temperature	-25 ... 80 °C
Degree of protection	IP67
Mechanical life	30 x 10 ⁶
Contact material	Silver alloy, gold flashed
Switching principle	Snap-action switching contact ^[1]
Installation position	Any
Number of door position positively driven contacts	1
Number of NO contacts	1
Connection	1 x M20 x 1.5
Approach speed	max. 0,1 ... 60 m/min
Actuating element	Ball bearing Lever arm ^[2]
Actuating force	min.15 N

Electrical connection ratings

Rated thermal current I _{th}	6 A
Utilization category according to EN 60947-5-1	AC-15 6A 230V DC-13 6A 24V AC-12 10A 230V
Short circuit protection according to IEC 60269-1	(Fuse) 6A gG
Rated insulation voltage U _i	250 V
Rated impulse withstand voltage U _{imp}	2,5 kV
Switching current	Min. at DC 24V 10 mA
Connection cross-section	0,34 ... 1,5 mm ²

Miscellaneous

C number	C1833	[3]
----------	-------	-----

Reliability values acc. to EN ISO 13849-1

	Monitoring of the safety guard position
B10 _D	20 x 10 ⁶

[1] Contact closing time <4 contact bounce time <3

[2] d roller = 19 mm length 32 mm

[3] With sealed ball bearings

Dimension drawing

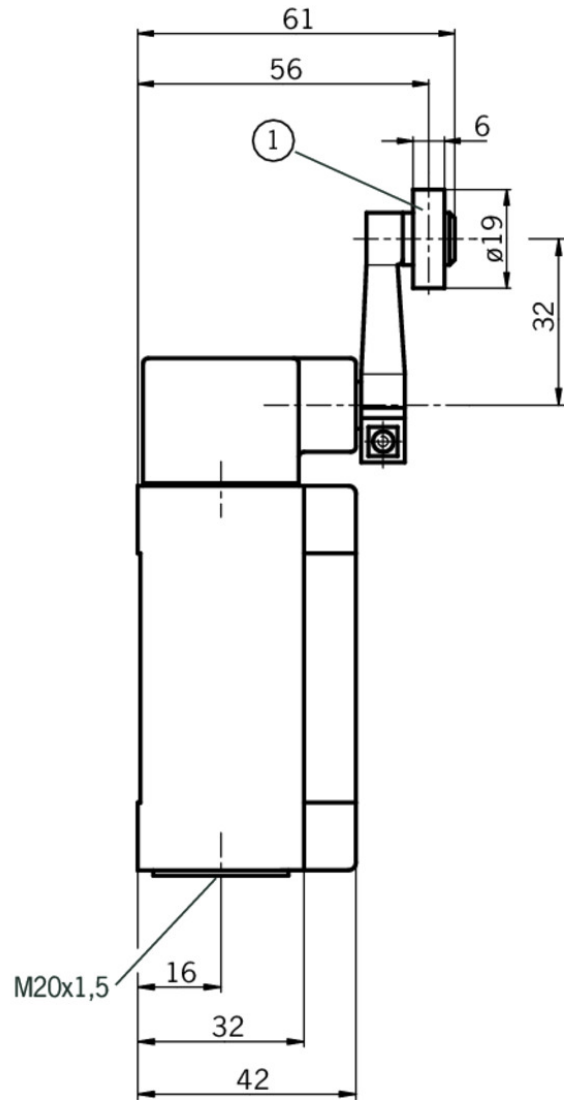
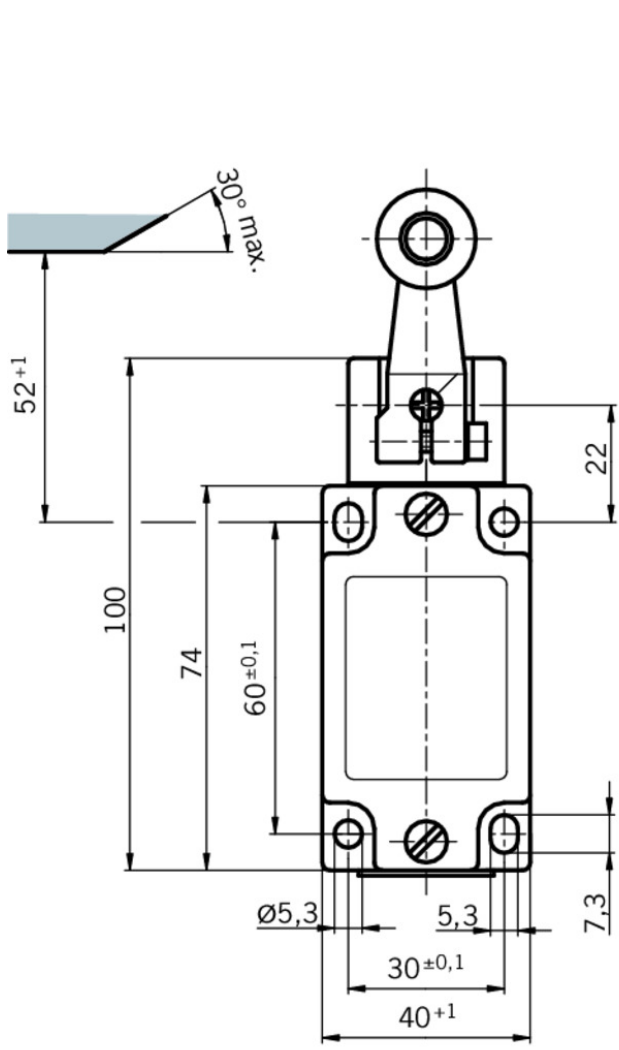

Legende

1 Ball bearing

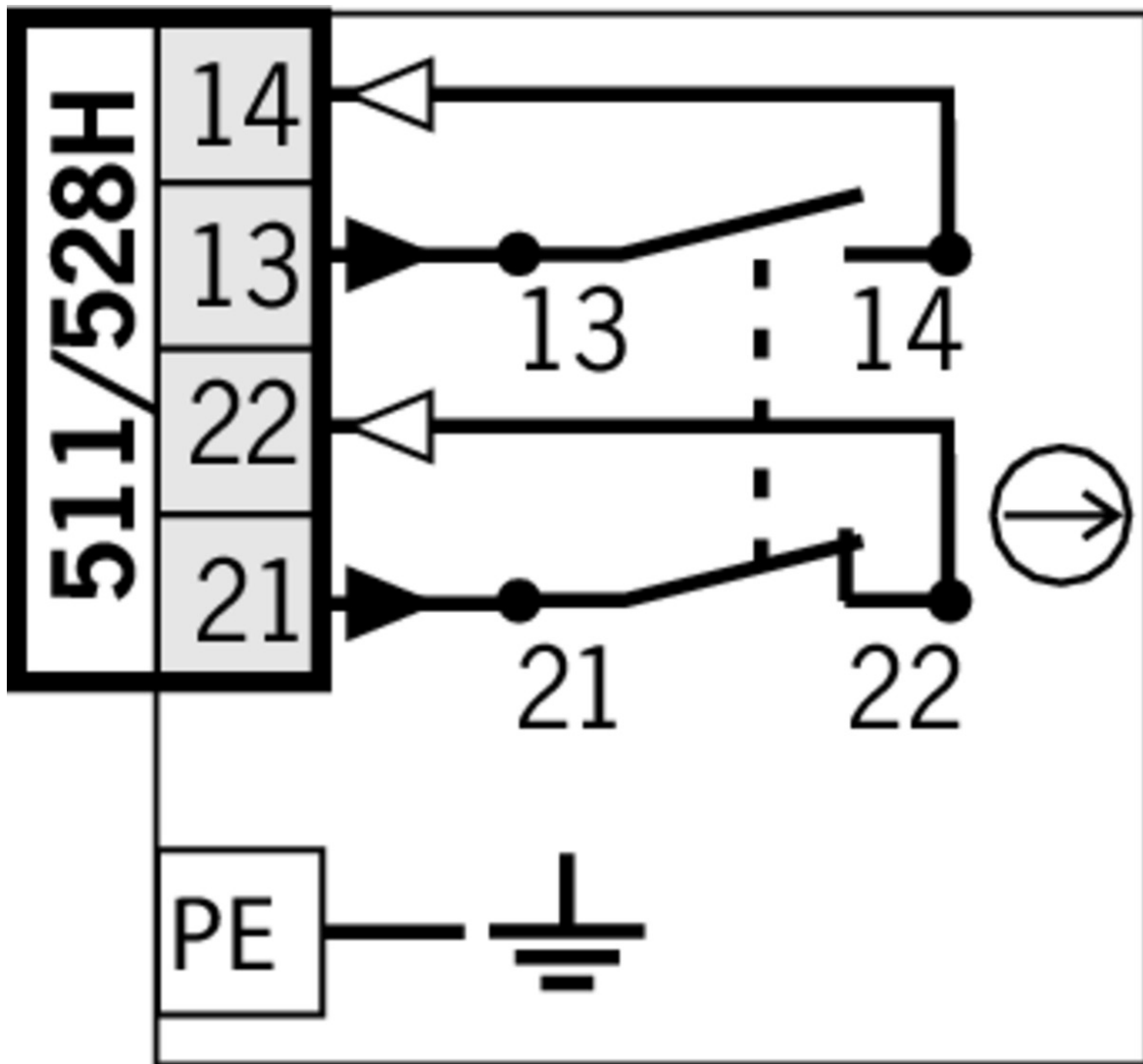



Travel diagram

NZ...HS
NZ...HB

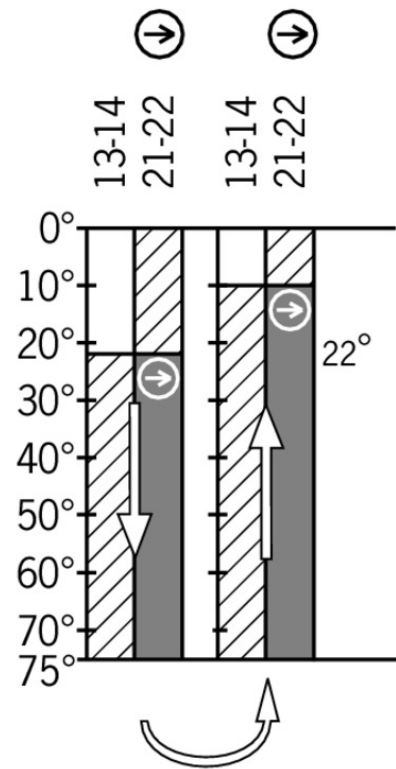
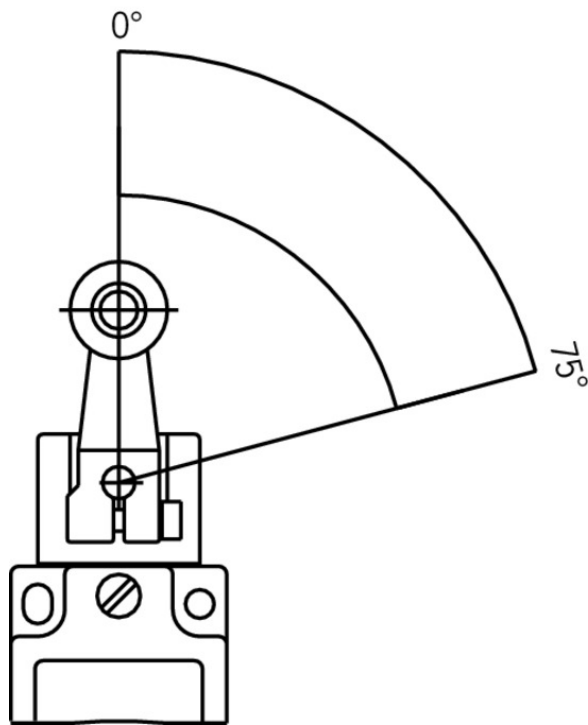
511



Legende

-  Contacts closed
-  Contacts open
-  Contacts positively driven

Connection material

-  Cable glands M20x1.5



077684 EKVM20/09



077683 EKVM20/06

Spare parts

-  Lever arm with steel roller



012043 NHS ROLLENHEBEL

Features

- › Steel roller Ø18mm

Instructions

Betriebsanleitung Sicherheitsschalter NZ.H/P

	Doc. no.	Version	Language	Download
Betriebsanleitung Sicherheitsschalter NZ.H/P Manual de instrucciones Interruptores de seguridad NZ.H/P Mode d'emploi Interrupteur de sécurité NZ.H/P Istruzioni di impiego Finecorsa di sicurezza NZ.H/P Operating Instructions Safety Switch NZ.H/P	074550	11-12/16	 	2.1 MB
Instrukcja obsługi Wyłącznik bezpieczeństwa NZ.H/P	074550	11-12/16		0.5 MB
Инструкция по эксплуатации Предохранительный выключатель NZ.H/P	074550	11-12/16		0.6 MB
Návod na prevádzku Bezpečnostný spínač NZ.H/P	074550	11-12/16		0.5 MB

Catalogs











Sicherheitsschalter mit Metallgehäuse Safety Switches with Metal Housing Bezpečnostní spínače s kovovým pouzdem Interrupteurs de sécurité avec boîtier métallique 金属壳体 的安全开关 Interruptores de seguridad con carcasa metálica

	Doc. no.	Version	Language	Download
Sicherheitsschalter mit Metallgehäuse	100319	11-03/18		7.9 MB
Interrupteurs de sécurité avec boîtier métallique	100676	11-03/18		7.9 MB
Interruptores de seguridad con carcasa metálica	104856	11-03/18		14.0 MB
Safety Switches with Metal Housing	100369	11-03/18		7.9 MB
Bezpečnostní spínače s kovovým pouzdem	121650	11-03/18		7.9 MB
金属壳体 的安全开关	102453	11-03/18		8.2 MB

Declaration of conformity

EU prohlášení o shodě

	Doc. no.	Version	Language	Download
EU-Konformitätserklärung Declaración UE de conformidad Déclaration UE de conformité Dichiarazione di conformità EU declaration of conformity	2077153	25-02/17	 	0.3 MB

EU prohlášení o shodě	2077153	25-02/17		 0.5 MB
EU-overensstemmelseserklæring				
Δήλωση συμμόρφωσης της ΕΕ				
EU-vaatimustenmukaisuusvakuutus				
EU-típusbizonyítvány				
EU-conformiteitsverklaring				
Deklaracja zgodności UE				
Declaração de Conformidade UE				
Declarația de conformitate UE				
EÚ vyhlásenie o zhode				

CAD data

CAD data for this item on TraceParts