

## ITEM 104012 SGA2A-2121ARC18-EXT5

Description	Technical data	Accessories	Downloads
-------------	----------------	-------------	-----------



### Features

- › 2 illuminated pushbuttons
- › Plug connector M23 (RC18)
- › Switching disc made of metal

### Approach direction



- › Figure  
Horizontal and vertical  
Can be adjusted in 90° steps

### Switching element

**2121** Slow-action switching contact 4 NC ⊕

## Approvals



## Mechanical values and environment

Housing material	Die-cast alloy, cathodically dipped
Weight	Net 0,5 kg
Ambient temperature	-20 ... 80 °C
Degree of protection	IP54
Mechanical life	2 x 10 <sup>6</sup>
Contact material	Silver alloy, gold flashed
Switching principle	Slow-action switching contact
Installation position	Any
Number of door position positively driven contacts	4
Connection	1 x Plug connector RC18 [1]
Approach speed	max. 20 m/min
Actuation frequency	6700 1/h
Retention force	10 N
Extraction force	25 N
Actuating force	25 N
Insertion depth	24,5 mm

## Electrical connection ratings

Rated thermal current $I_{th}$	1 A
Utilization category according to EN 60947-5-1	DC-13 1A 24V
Short circuit protection according to IEC 60269-1	(Fuse) 1A gG
Rated insulation voltage $U_i$	32 V
Rated impulse withstand voltage $U_{imp}$	1,5 kV
Switching voltage	Min. at 10mA 12 V
Switching current	Min. at 24V 1 mA

## Miscellaneous

Additional feature	2 x push buttons	Yellow, white (illuminated) [2]
--------------------	------------------	---------------------------------

**Reliability values acc. to EN ISO 13849-1**

		<b>Monitoring of the safety guard position</b>
B10D		$3 \times 10^6$

**in combination with Actuator BETAETIGER-S-GT-SN**

**Mechanical values and environment**

Overtravel	5 mm
------------	------

[1] 18-pin + PE

[2] 24V (max. breaking capacity 250mW)

## Dimension drawing

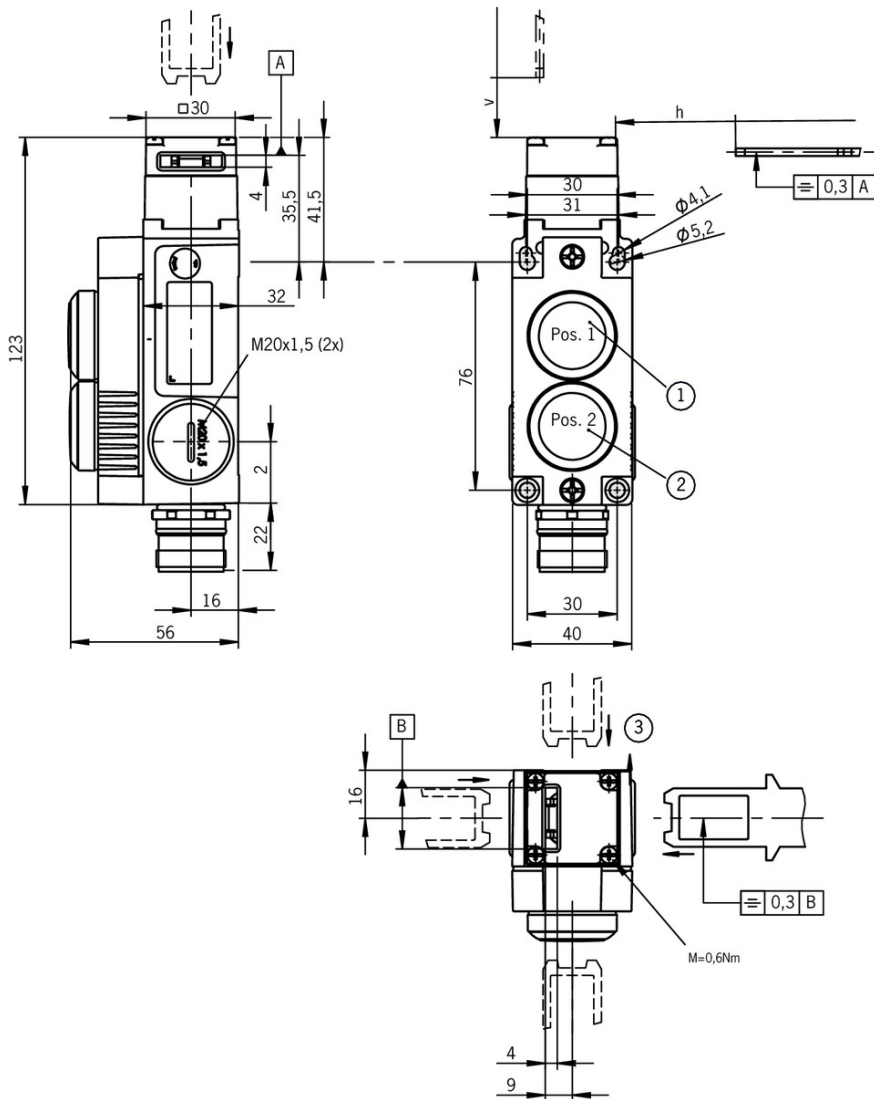

## Legende

- 1 Pushbutton S1, yellow illuminated
- 2 Pushbutton S2, white illuminated
- 3 Actuating direction can be changed

## 2121 EXT5

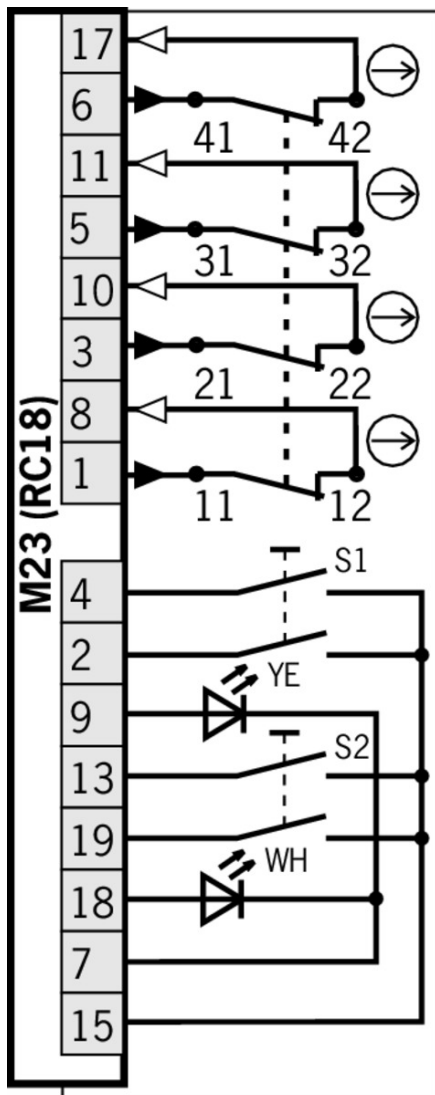

### Bolt

- ✓ Bolt BTC-ST/G... without escape release for safety switches STA, STP, SGP and SGA



#### **106284** BTC-ST/G-S-TH-00-X

##### ✓ Features

- › Aluminum bolt
- › For doors hinged on the left or right
- › Can be locked in open position with padlocks
- › Actuator included

- ✓ Bolt BTC-ST/G... with escape release for safety switches STA, STP, SGP and SGA



#### **106285** BTC-ST/G-S-TH-01-F

##### ✓ Features

- › Aluminum bolt
- › For doors hinged on the left or right
- › Lever for escape release from the danger area
- › Pushbutton in open position
- › Can be locked in open position with padlocks

- › Actuator included
- 

## Connection material

---

- ▼ Female plug RC18 straight with option C1825



**077025** RC18EF-C1825

- ▼ Features

- › Plug connector M23, straight
  - › Number of pins: 19-pin with screen bonding clamp
- 

- ▼ Female plug RC18 straight



**074616** RC18EF

- ▼ Features

- › Plug connector M23, straight
  - › Number of pins: 19-pin with screen bonding clamp
- 

- ▼ Female plug RC18 angled



**074617** RC18WF

- ▼ Features

- › Plug connector M23, angled
  - › Number of pins: 19-pin with screen bonding clamp
- 

- ▼ Replacement crimp contacts for female connector RC18

**094309** CRIMPKONTAKT BUCHSE RCF

- ▼ Features

- › 19 crimp sockets
  - › Conductor cross-section 19 x 0.75 - 1 mm<sup>2</sup>
  - › For plug connector RC18
- 

- ▼ Female connector RC18 angled with option C1825



**077026** RC18WF-C1825

- ▼ Features

- › Plug connector M23, angled
  - › Number of pins: 19-pin with screen bonding clamp
- 

- ▼ Replacement crimp contacts for female connector RC18 with option C1825

**094310** CRIMPKONTAKT BUCHSE RCF-C1825

- ▼ Features

- › 19 crimp sockets
  - › Conductor cross-section 16 x 0.25 - 0.5 mm<sup>2</sup> and 3 x 0.75 - 1 mm<sup>2</sup>
  - › For plug connector RC18..C1825
-

- ▼ Connection cable with plug connector M23 with option C1825, 1.5m, straight



**092761** C-M23F19-19XDIFPU01,5-MA-092761

▼ Features

- › M23 plug connector, 18-pin + PE
  - › Straight plug connector
  - › PUR cable
  - › Cable length 1.5 m
  - › With flying lead
  - › Cores color-coded
- 

- ▼ Connection cable with plug connector M23 with option C1825, 15m, straight



**077016** C-M23F19-19XDIFPU15,0-MA-077016

▼ Features

- › M23 plug connector, 18-pin + PE
  - › Straight plug connector
  - › PUR cable
  - › Cable length 15 m
  - › With flying lead
  - › Cores color-coded
- 

- ▼ Connection cable with plug connector M23 with option C1825, 6m, straight



**077014** C-M23F19-19XDIFPU06,0-MA-077014

▼ Features

- › M23 plug connector, 18-pin + PE
  - › Straight plug connector
  - › PUR cable
  - › Cable length 6 m
  - › With flying lead
  - › Cores color-coded
- 

- ▼ Connection cable with plug connector M23 with option C1825, 8m, straight



**077015** C-M23F19-19XDIFPU08,0-MA-077015

▼ Features

- › M23 plug connector, 18-pin + PE
  - › Straight plug connector
  - › PUR cable
  - › Cable length 8 m
  - › With flying lead
  - › Cores color-coded
- 

- ▼ Connection cable with plug connector M23 with option C1825, 10m, straight



**092898** C-M23F19-19XDIFPU10,0-MA-092898

▼ Features

- › M23 plug connector, 18-pin + PE
- › Straight plug connector
- › PUR cable
- › Cable length 10 m
- › With flying lead
- › Cores color-coded

- 
- ▼ Connection cable with plug connector M23 with option C1825, 20m, straight



**092726** C-M23F19-19XDIFPU20,0-MA-092726

▼ Features

- › M23 plug connector, 18-pin + PE
- › Straight plug connector
- › PUR cable
- › Cable length 20 m
- › With flying lead
- › Cores color-coded

- 
- ▼ Connection cable with plug connector M23 with option C1825, 25m, straight



**092727** C-M23F19-19XDIFPU25,0-MA-092727

▼ Features

- › M23 plug connector, 18-pin + PE
- › Straight plug connector
- › PUR cable
- › Cable length 25 m
- › With flying lead
- › Cores color-coded

- 
- ▼ Connection cable with plug connector M23 with option C1825, 30m, straight



**095993** C-M23F19-19XDIFPU30,0-MA-095993

▼ Features

- › M23 plug connector, 18-pin + PE
- › Straight plug connector
- › PUR cable
- › Cable length 30 m
- › With flying lead
- › Cores color-coded

- 
- ▼ Connection cable with plug connector M23 with option C1825, 40m, straight



**102490** C-M23F19-19XDIFPU40,0-MA-102490

▼ Features

- › M23 plug connector, 18-pin + PE
- › Straight plug connector
- › PUR cable
- › Cable length 40 m
- › With flying lead
- › Cores color-coded

- 
- ▼ Connection cable with plug connector M23, 19-pin, 1.5m, straight



**110301** C-M23F19-19XDIFPU01,5-MA-110301

▼ Features

- › M23 female plug, 19-pin
- › Straight plug connector
- › PUR cable



- › Cable length 1.5 m
  - › With flying lead
  - › Cores numbered, black
- 

▼ Connection cable with plug connector M23, 19-pin, 3m, straight



**110302** C-M23F19-19XDIFPU03,0-MA-110302

▼ Features

- › M23 female plug, 19-pin
  - › Straight plug connector
  - › PUR cable
  - › Cable length 3 m
  - › With flying lead
  - › Cores numbered, black
- 

▼ Connection cable with plug connector M23, 19-pin, 6m, straight



**110303** C-M23F19-19XDIFPU06,0-MA-110303

▼ Features

- › M23 female plug, 19-pin
  - › Straight plug connector
  - › PUR cable
  - › Cable length 6 m
  - › With flying lead
  - › Cores numbered, black
- 

▼ Connection cable with plug connector M23, 19-pin, 10m, straight



**110304** C-M23F19-19XDIFPU10,0-MA-110304

▼ Features

- › M23 female plug, 19-pin
  - › Straight plug connector
  - › PUR cable
  - › Cable length 10 m
  - › With flying lead
  - › Cores numbered, black
- 

▼ Connection cable with plug connector M23, 19-pin, 15m, straight



**110305** C-M23F19-19XDIFPU15,0-MA-110305

▼ Features

- › M23 female plug, 19-pin
  - › Straight plug connector
  - › PUR cable
  - › Cable length 15 m
  - › With flying lead
  - › Cores numbered, black
- 

▼ Connection cable with plug connector M23, 19-pin, 20m, straight



**110306** C-M23F19-19XDIFPU20,0-MA-110306

▼ Features

- › M23 female plug, 19-pin
  - › Straight plug connector
  - › PUR cable
  - › Cable length 20 m
  - › With flying lead
  - › Cores numbered, black
- 

- ▼ Connection cable with plug connector M23, 19-pin, 25m, straight



**110307** C-M23F19-19XDIFPU25,0-MA-110307

▼ Features

- › M23 female plug, 19-pin
  - › Straight plug connector
  - › PUR cable
  - › Cable length 25 m
  - › With flying lead
  - › Cores numbered, black
- 

## Actuator

---

- ▼ Hinged actuator L top/bottom, for safety switches SGA/SGP/STA/STP/STM for insertion funnel



**096697** RADIUSBETAETIGER-S-OU-LN

▼ Features

- › Actuators made of stainless steel
  - › Two stainless safety screws per actuator
  - › For doors hinged at top and bottom
- 

- ▼ Hinged actuator L left/right, for safety switches SGA/SGP/STA/STP/STM for insertion funnel



**096844** RADIUSBETAETIGER-S-LR-LN

▼ Features

- › Actuators made of stainless steel
  - › Two stainless safety screws per actuator
  - › For doors hinged on right and left
- 

- ▼ Hinged actuator S left/right for safety switches SGA/SGP/STA/STP/STM



**096838** RADIUSBETAETIGER-S-LR-SN

▼ Features

- › Actuators made of stainless steel
  - › Two safety screws included
  - › For doors hinged on right and left
- 

- ▼ Hinged actuator S top/bottom for safety switches SGA/SGP/STA/STP/STM



**095315** RADIUSBETAETIGER-S-OU-SN

▼ Features

- › Actuators made of stainless steel
- › Two safety screws included

- › For doors hinged at top and bottom

---

▼ Actuator L, bent, for safety switches SGA/SGP/STA/STP/STM for insertion funnel



**095741** BETAETIGER-S-WQT-LN

▼ Features

- › Two safety screws included
- › Actuators with rubber bushings



**105809** BETAETIGER-S-WT-LN-C2115

▼ Features

- › Two stainless safety screws per actuator
- › Actuators with rubber bushings
- › Minimum door radius 300 mm

---

▼ Actuator L for safety switches SGA/SGP/STA/STP/STM for insertion funnel



**095739** BETAETIGER-S-GT-LN

▼ Features

- › Two safety screws included
- › Actuators with rubber bushings

---

▼ Actuator S, bent, for safety switches SGA/SGP/STA/STP/STM



**095740** BETAETIGER-S-WQT-SN

▼ Features

- › Two safety screws included



**115073** BETAETIGER-S-W-SN-C2115

▼ Features

- › Two stainless safety screws per actuator
- › Minimum door radius 300 mm



**105808** BETAETIGER-S-WT-SN-C2115

▼ Features

- › Two stainless safety screws per actuator
- › Actuators with rubber bushings
- › Minimum door radius 300 mm

---

▼ Actuator S for safety switches SGA/SGP/STA/STP/STM



**095738** BETAETIGER-S-GT-SN

▼ Features

- › Two safety screws included
- › Actuators with rubber bushings



**097861** BETAETIGER-S-G-SN-C2115

▼ Features

- › Two safety screws included

- › Physically compatible with TP actuator P-G

---

## Mounting accessories

---

- ▼ Mounting plates EMP-B2 for actuators for safety switches CTP, TP...A, STA, STP, TX and TZ



**093458** EMP-B2

- 
- ▼ Mounting plates EMP-SB for safety switches CTP, TP...A, STA, STP and TX



**093456** EMP-SB

- ▼ Features

- › For vertical and horizontal mounting of safety switches TP...A, STA, STP and TX

- 
- ▼ Mounting plates EMP-B1 for actuators for safety switches CTP, TP...A, STA, STP, TX and TZ



**093457** EMP-B1

---

## Function expansion

---

- ▼ Lockout bar STA/STP/SGA/SGP/STM



**105701** SPERREINSATZ STP/STA

- ▼ Features

- › Prevents unintentional closing of the door
- › Can be secured with padlocks

- 
- ▼ Insertion funnel for safety switches SGP/STA/STP/STM/SGA









**093157** EINFUEHRTRICHTER-S

---

## Instructions











- ▼ Betriebsanleitung Sicherheitsschalter SGA...

**Doc. no.**   **Version**   **Language**   **Download**













Betriebsanleitung Sicherheitsschalter SGA...	103727	04-08/15		 2.6 MB
Manual de instrucciones Interruptores de seguridad SGA...				
Mode d'emploi Interrupteur de sécurité SGA...				
Istruzioni di impiego Finecorsa di sicurezza SGA...				
Operating Instructions Safety Switch SGA...				

## Catalogs

- Bezpečnostní spínače s plastovým pouzdrém Sicherheitsschalter mit Kunststoffgehäuse Safety Switches with Plastic Housing Interruptores de seguridad con carcasa plástica Interrupteurs de sécurité avec boîtier plastique 塑料壳体 的安全开关







	Doc. no.	Version	Language	Download
Sicherheitsschalter mit Kunststoffgehäuse	096955	11-03/18		 6.6 MB
Interrupteurs de sécurité avec boîtier plastique	100677	11-03/18		 6.6 MB
Interruptores de seguridad con carcasa plástica	104855	11-03/18		 6.6 MB
Bezpečnostní spínače s plastovým pouzdrém	121649	11-03/18		 6.6 MB
Safety Switches with Plastic Housing	096956	11-03/18		 6.6 MB
塑料壳体 的安全开关	116243	11-03/18		 6.2 MB











- Sicherheitsschalter mit Metallgehäuse Safety Switches with Metal Housing Bezpečnostní spínače s kovovým pouzdrém Interrupteurs de sécurité avec boîtier métallique 金属壳体 的安全开关 Interruptores de seguridad con carcasa metálica

	Doc. no.	Version	Language	Download
Sicherheitsschalter mit Metallgehäuse	100319	11-03/18		 7.9 MB
Interrupteurs de sécurité avec boîtier métallique	100676	11-03/18		 7.9 MB
Interruptores de seguridad con carcasa metálica	104856	11-03/18		 14.0 MB
Safety Switches with Metal Housing	100369	11-03/18		 7.9 MB
Bezpečnostní spínače s kovovým pouzdrém	121650	11-03/18		 7.9 MB
金属壳体 的安全开关	102453	11-03/18		 8.2 MB

## Declaration of conformity

- EU prohlášení o shodě

	Doc. no.	Version	Language	Download
EU-Konformitätserklärung	2077153	25-02/17		 0.3 MB
Declaración UE de conformidad				
Déclaration UE de conformité				
Dichiarazione di conformità				
EU declaration of conformity				

EU prohlášení o shodě	2077153	25-02/17		 0.5 MB
EU-overensstemmelseserklæring				
Δήλωση συμμόρφωσης της ΕΕ				
EU-vaatimustenmukaisuusvakuutus				
EU-típusbizonyítvány				
EU-conformiteitsverklaring				
Deklaracja zgodności UE				
Declaração de Conformidade UE				
Declarația de conformitate UE				
EÚ vyhlásenie o zhode			