

ITEM 106736 SGA2E-2131ASR11

Description	Technical data	Accessories	Downloads
-------------	----------------	-------------	-----------



Features

- › Plug connector SR11
- › Switching disc made of plastic

Approach direction

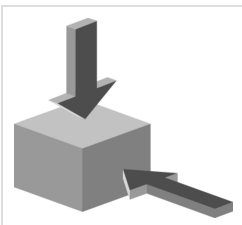

- › Figure
Horizontal and vertical
Can be adjusted in 90° steps

Switching element

2131 Slow-action switching contact 3 NC⊖ + 1 NO

Approvals



Mechanical values and environment

Housing material	Die-cast alloy, cathodically dipped
Weight	Net 0,5 kg
Ambient temperature	-20 ... 80 °C
Degree of protection	IP65
Mechanical life	2×10^6
Contact material	Silver alloy, gold flashed
Switching principle	Slow-action switching contact
Installation position	Any
Number of door position positively driven contacts	3
Connection	1 x Plug connector SR11 [1]
Approach speed	max. 20 m/min
Actuation frequency	6700 1/h
Retention force	10 N
Extraction force	25 N
Actuating force	25 N
Insertion depth	24,5 mm

Electrical connection ratings

Rated thermal current I_{th}	4 A
Utilization category according to EN 60947-5-1	AC-15 4A 50V DC-13 4A 24V
Short circuit protection according to IEC 60269-1	(Fuse) 4A gG
Rated insulation voltage U_i	50 V
Rated impulse withstand voltage U_{imp}	1,5 kV
Switching voltage	Min. at 10mA 12 V
Switching current	Min. at 24V 1 mA

Reliability values acc. to EN ISO 13849-1

	Monitoring of the safety guard position
B10 _D	3×10^6

in combination with Actuator **BETAETIGER-S-GT-SN**

Mechanical values and environment

Overtravel	5 mm
------------	------

[1] 11-pin + PE

Dimension drawing

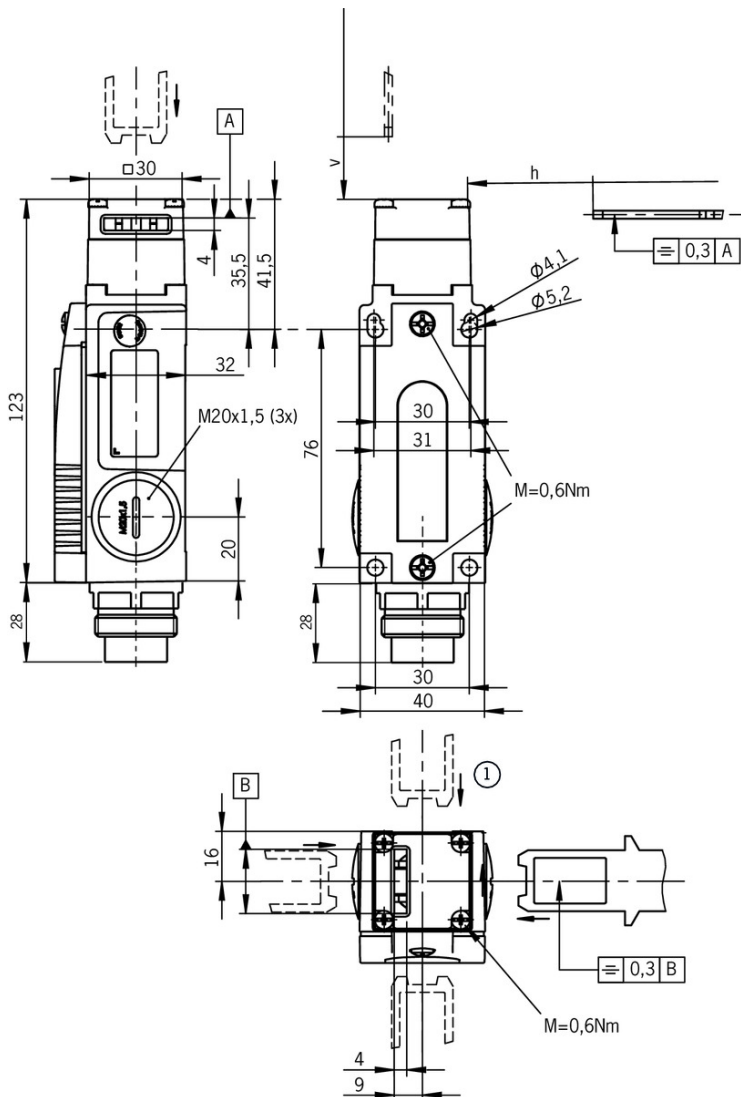

Legende

1 Actuating direction can be changed

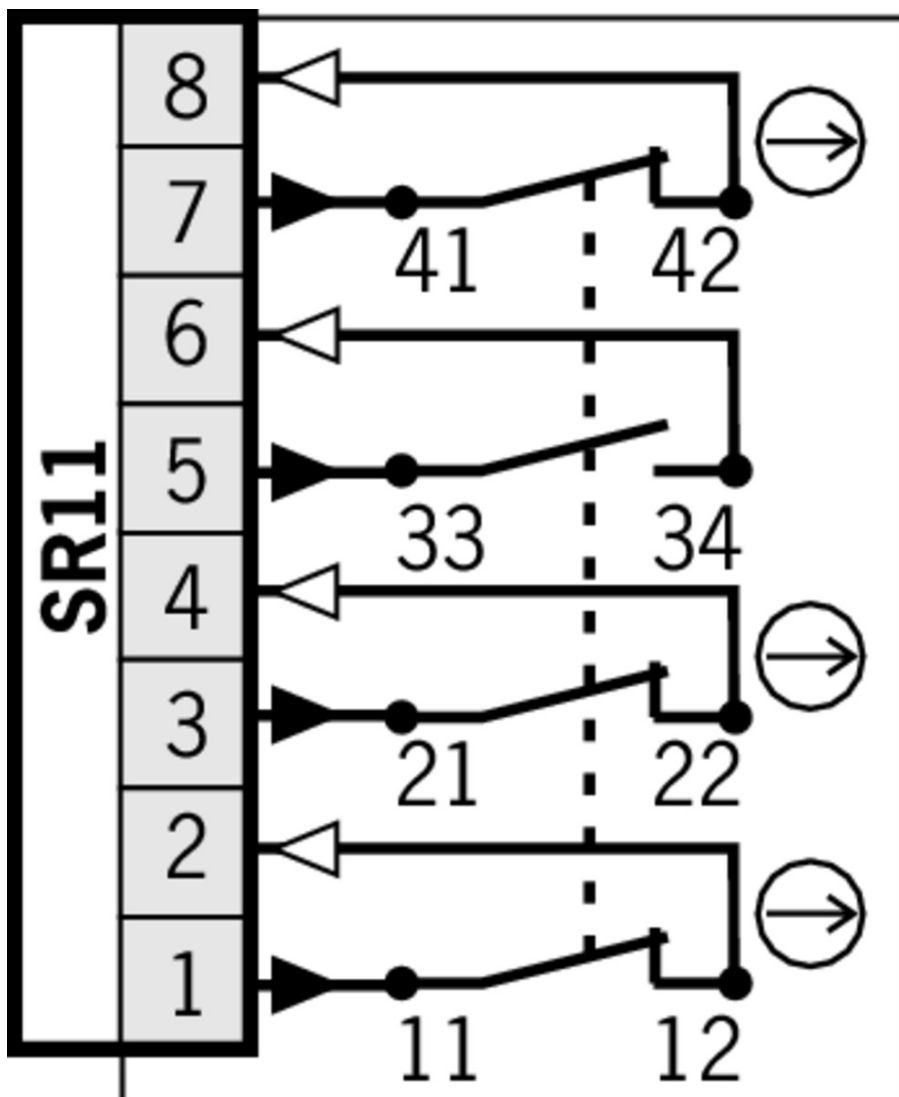

Connection material

- Connection cable with plug connector SR11, 10m



077630 C-M26F12-12X1,00PU10,0-MA-077630

Features

- › Female plug SR11, 11-pin + PE
- › Straight plug connector
- › PUR cable
- › Cable length 10 m
- › With flying lead

- Connection cable with plug connector SR11, 5m



077629 C-M26F12-12X1,00PU05,0-MA-077629

Features

- › Female plug SR11, 11-pin + PE
- › Straight plug connector
- › PUR cable
- › Cable length 5 m

- › With flying lead

☑ Connection cable with plug connector SR11, 15m



077631 C-M26F12-12X1,00PU15,0-MA-077631

☑ Features

- › Female plug SR11, 11-pin + PE
- › Straight plug connector
- › PUR cable
- › Cable length 15 m
- › With flying lead

☑ Plug connector SR11 for safety switches NZ and TZ

070859 SR11EF

☑ Features

- › Crimp contacts
- › Cable optional
- › Coding shells

054773 SR11WF

☑ Features

- › Crimp contacts
- › 90° angled optional
- › Cable optional
- › Coding shells

091296 SR11AM2-M20

☑ Features

- › Crimp contacts
- › Cable optional
- › Coding shells

☑ Connection cable with plug connector SR11, 20m



096632 C-M26F12-12X1,0PU20,0-MA-096632

☑ Features

- › Female plug SR11, 11-pin + PE
- › Straight plug connector
- › PUR cable
- › Cable length 20 m
- › With flying lead

☑ Connection cable with plug connector SR11, 25m



094749 C-M26F12-12X1,0PU25,0-MA-094749

☑ Features

- › Female plug SR11, 11-pin + PE
- › Straight plug connector
- › PUR cable
- › Cable length 25 m

- › With flying lead

-
- ✓ Connection cable with plug connector SR11, 5m, angled



077635 C-M26F12-12X1,0PU05,0-MA-077635

✓ Features

- › Female plug SR11, 11-pin + PE
- › Angled plug connector
- › PUR cable
- › Cable length 5 m
- › With flying lead

-
- ✓ Connection cable with plug connector SR11, 10m, angled



077636 C-M26F12-12X1,0PU10,0-MA-077636

✓ Features

- › Female plug SR11, 11-pin + PE
- › Angled plug connector
- › PUR cable
- › Cable length 10 m
- › With flying lead

-
- ✓ Connection cable with plug connector SR11, 15m, angled



077637 C-M26F12-12X1,0PU15,0-MA-077637

✓ Features

- › Female plug SR11, 11-pin + PE
- › Angled plug connector
- › PUR cable
- › Cable length 15 m
- › With flying lead

Actuator

- ✓ Hinged actuator S left/right for safety switches SGA/SGP/STA/STP/STM



096838 RADIUSBETAETIGER-S-LR-SN

✓ Features

- › Actuators made of stainless steel
- › Two safety screws included
- › For doors hinged on right and left

-
- ✓ Hinged actuator L top/bottom, for safety switches SGA/SGP/STA/STP/STM for insertion funnel



096697 RADIUSBETAETIGER-S-OU-LN

✓ Features

- › Actuators made of stainless steel
 - › Two stainless safety screws per actuator
 - › For doors hinged at top and bottom
-

- ▼ Hinged actuator L left/right, for safety switches SGA/SGP/STA/STP/STM for insertion funnel



096844 RADIUSBETAETIGER-S-LR-LN

▼ Features

- › Actuators made of stainless steel
 - › Two stainless safety screws per actuator
 - › For doors hinged on right and left
-

- ▼ Actuator S for safety switches SGA/SGP/STA/STP/STM



097861 BETAETIGER-S-G-SN-C2115

▼ Features

- › Two safety screws included
 - › Physically compatible with TP actuator P-G
-



095738 BETAETIGER-S-GT-SN

▼ Features

- › Two safety screws included
 - › Actuators with rubber bushings
-

- ▼ Actuator S, bent, for safety switches SGA/SGP/STA/STP/STM



095740 BETAETIGER-S-WQT-SN

▼ Features

- › Two safety screws included
-



115073 BETAETIGER-S-W-SN-C2115

▼ Features

- › Two stainless safety screws per actuator
 - › Minimum door radius 300 mm
-



105808 BETAETIGER-S-WT-SN-C2115

▼ Features

- › Two stainless safety screws per actuator
 - › Actuators with rubber bushings
 - › Minimum door radius 300 mm
-

- ▼ Actuator L for safety switches SGA/SGP/STA/STP/STM for insertion funnel



095739 BETAETIGER-S-GT-LN

▼ Features

- › Two safety screws included
 - › Actuators with rubber bushings
-

- ▼ Actuator L, bent, for safety switches SGA/SGP/STA/STP/STM for insertion funnel



095741 BETAETIGER-S-WQT-LN

▼ Features

- › Two safety screws included
- › Actuators with rubber bushings



105809 BETAETIGER-S-WT-LN-C2115

✓ Features

- › Two stainless safety screws per actuator
- › Actuators with rubber bushings
- › Minimum door radius 300 mm

✓ Hinged actuator S top/bottom for safety switches SGA/SGP/STA/STP/STM



095315 RADIUSBETAETIGER-S-OU-SN

✓ Features

- › Actuators made of stainless steel
- › Two safety screws included
- › For doors hinged at top and bottom

Mounting accessories

✓ Mounting plates EMP-SB for safety switches CTP, TP...A, STA, STP and TX



093456 EMP-SB

✓ Features

- › For vertical and horizontal mounting of safety switches TP...A, STA, STP and TX

✓ Mounting plates EMP-B1 for actuators for safety switches CTP, TP...A, STA, STP, TX and TZ



093457 EMP-B1

✓ Mounting plates EMP-B2 for actuators for safety switches CTP, TP...A, STA, STP, TX and TZ



093458 EMP-B2

Bolt

✓ Bolt BTC-ST/G... with escape release for safety switches STA, STP, SGP and SGA



106285 BTC-ST/G-S-TH-01-F

✓ Features

- › Aluminum bolt
- › For doors hinged on the left or right
- › Lever for escape release from the danger area
- › Pushbutton in open position
- › Can be locked in open position with padlocks
- › Actuator included

✓ Bolt BTC-ST/G... without escape release for safety switches STA, STP, SGP and SGA



106284 BTC-ST/G-S-TH-00-X

Features

- › Aluminum bolt
- › For doors hinged on the left or right
- › Can be locked in open position with padlocks
- › Actuator included

Function expansion

Lockout bar STA/STP/SGA/SGP/STM



105701 SPERREINSATZ STP/STA

Features

- › Prevents unintentional closing of the door
- › Can be secured with padlocks

Insertion funnel for safety switches SGP/STA/STP/STM/SGA



093157 EINFUEHRTRICHTER-S

Instructions

Betriebsanleitung Sicherheitsschalter SGA...

	Doc. no.	Version	Language	Download
Betriebsanleitung Sicherheitsschalter SGA...	103727	04-08/15		2.6 MB
Manual de instrucciones Interruptores de seguridad SGA...				
Mode d'emploi Interrupteur de sécurité SGA...				
Istruzioni di impiego Finecorsa di sicurezza SGA...				
Operating Instructions Safety Switch SGA...				













Catalogs

Bezpečnostní spínače s plastovým pouzdrém Sicherheitsschalter mit Kunststoffgehäuse Safety Switches with Plastic Housing Interruptores de seguridad con carcasa plástica Interrupteurs de sécurité avec boîtier plastique 塑料壳体 的安全开关

	Doc. no.	Version	Language	Download
Sicherheitsschalter mit Kunststoffgehäuse	096955	11-03/18		6.6 MB
Interrupteurs de sécurité avec boîtier plastique	100677	11-03/18		6.6 MB
Interruptores de seguridad con carcasa plástica	104855	11-03/18		6.6 MB
Bezpečnostní spínače s plastovým pouzdrém	121649	11-03/18		6.6 MB
Safety Switches with Plastic Housing	096956	11-03/18		6.6 MB

塑料壳体 的安全开关 116243 11-03/18   6.2 MB

▼ Sicherheitsschalter mit Metallgehäuse Safety Switches with Metal Housing Bezpečnostní spínače s kovovým pouzdrém Interrupteurs de sécurité avec boîtier métallique 金属壳体 的安全开关 Interruptores de seguridad con carcasa metálica

	Doc. no.	Version	Language	Download
Sicherheitsschalter mit Metallgehäuse	100319	11-03/18		 7.9 MB
Interrupteurs de sécurité avec boîtier métallique	100676	11-03/18		 7.9 MB
Interruptores de seguridad con carcasa metálica	104856	11-03/18		 14.0 MB
Safety Switches with Metal Housing	100369	11-03/18		 7.9 MB
Bezpečnostní spínače s kovovým pouzdrém	121650	11-03/18		 7.9 MB
金属壳体 的安全开关	102453	11-03/18		 8.2 MB

Declaration of conformity

▼ EU prohlášení o shodě

	Doc. no.	Version	Language	Download
EU-Konformitätserklärung Declaración UE de conformidad Déclaration UE de conformité Dichiarazione di conformità EU declaration of conformity	2077153	25-02/17	    	 0.3 MB
EU prohlášení o shodě EU-overensstemmelseserklæring Δήλωση συμμόρφωσης της ΕΕ EU-vaatimustenmukaisuusvakuutus EU-típusbizonyítvány EU-conformiteitsverklaring Deklaracja zgodności UE Declaração de Conformidade UE Declarația de conformitate UE EÚ vyhlásenie o zhode	2077153	25-02/17	         	 0.5 MB