

**ITEM 097706 SGP1E-2131A-M**

Description	Technical data	Accessories	Downloads
-------------	----------------	-------------	-----------



**Features**

- › Actuating head made of metal
- › Cable entry M20 x 1.5

**Approach direction**

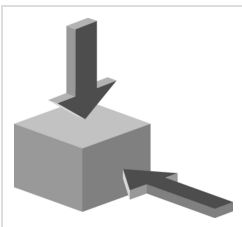

- › Figure  
Horizontal and vertical  
Can be adjusted in 90° steps

**Switching element**

**2131** Slow-action switching contact 3 NC⊖ + 1 NO

## Approvals



### Mechanical values and environment

Housing material	Reinforced thermoplastic
Weight	
Net	0,3 kg
Ambient temperature	-20 ... 80 °C
Degree of protection	IP67
Mechanical life	$2 \times 10^6$
Contact material	Silver alloy, gold flashed
Switching principle	Slow-action switching contact
Installation position	Any
Number of door position positively driven contacts	3
Number of door position NO contacts	1
Connection	
	3 x M20 x 1.5
Approach speed	
max.	20 m/min
Actuation frequency	6700 1/h
Retention force	10 N
Extraction force	25 N
Actuating force	25 N
Insertion depth	24,5 mm

### Electrical connection ratings

Rated thermal current $I_{th}$	4 A
Utilization category according to EN 60947-5-1	
AC-15	4A 230V
DC-13	4A 24V
Short circuit protection according to IEC 60269-1	
(Fuse)	4A gG
Rated insulation voltage $U_i$	250 V
Rated impulse withstand voltage $U_{imp}$	2,5 kV
Switching voltage	
Min. at 10mA	12 V
Switching current	
Min. at 24V	1 mA
Connection cross-section	0,34 ... 1,5 mm <sup>2</sup>

Reliability values acc. to EN ISO 13849-1

	Monitoring of the safety guard position
B10 <sub>D</sub>	$3 \times 10^6$

in combination with Actuator BETAETIGER-S-GT-SN

Mechanical values and environment

Overtravel	5 mm
------------	------

Dimension drawing

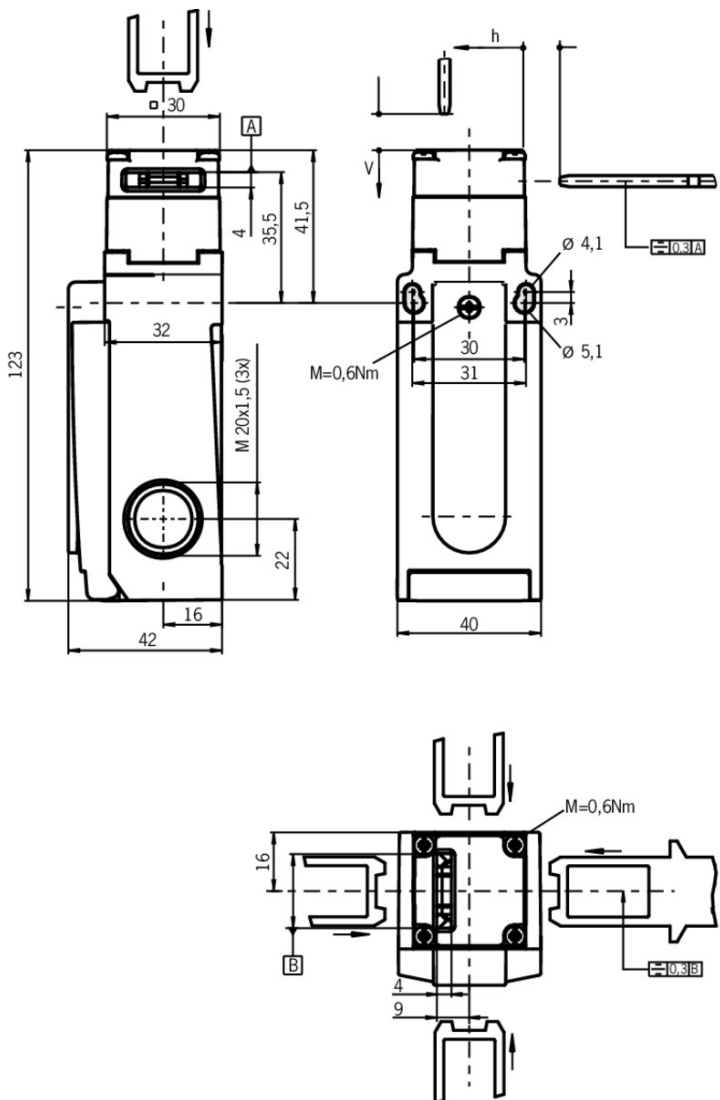

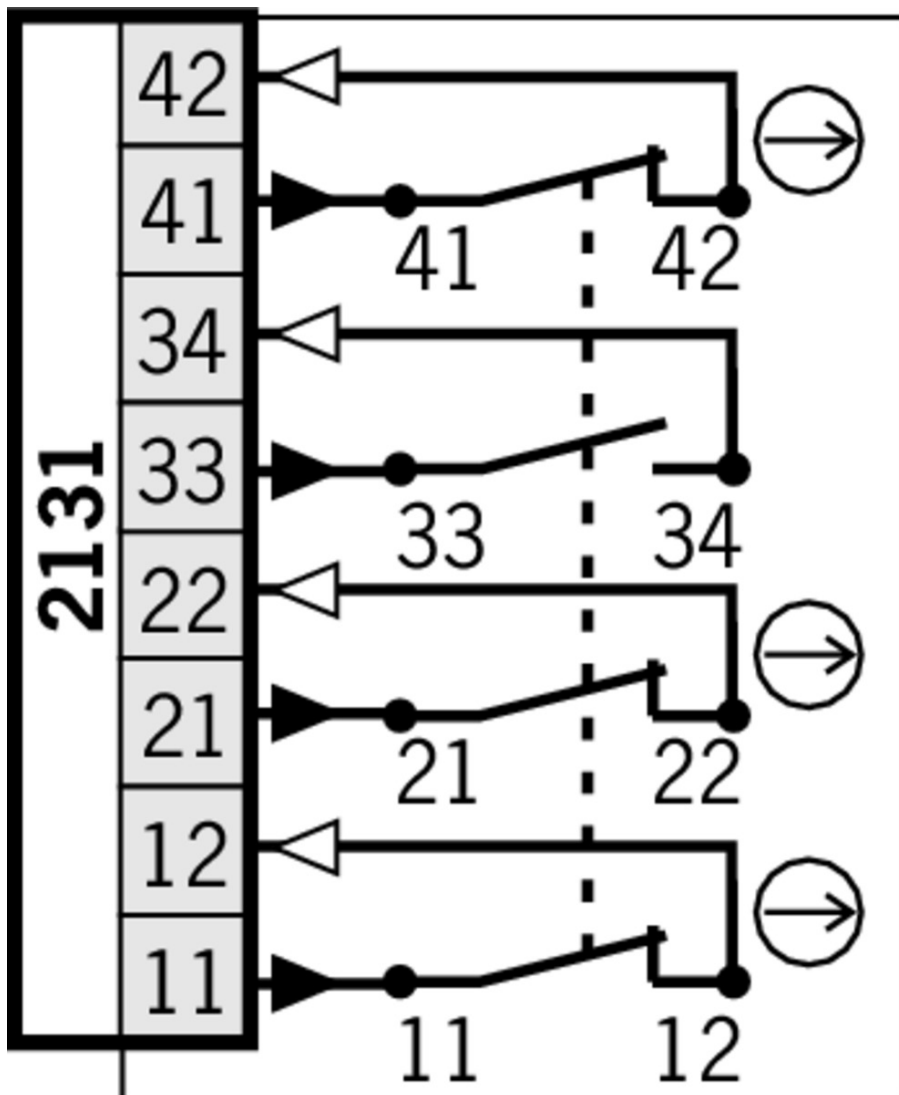

## Actuator

- ▼ Actuator S for safety switches SGA/SGP/STA/STP/STM



**097861** BETAETIGER-S-G-SN-C2115

- ▼ Features

- › Two safety screws included
- › Physically compatible with TP actuator P-G



**095738** BETAETIGER-S-GT-SN

- ▼ Features

- › Two safety screws included
- › Actuators with rubber bushings

- ▼ Actuator S, bent, for safety switches SGA/SGP/STA/STP/STM



**095740** BETAETIGER-S-WQT-SN

- ▼ Features

- › Two safety screws included

- 
- ▼ Actuator L for safety switches SGA/SGP/STA/STP/STM for insertion funnel



**095739** BETAETIGER-S-GT-LN

▼ Features

- › Two safety screws included
- › Actuators with rubber bushings

- 
- ▼ Actuator L, bent, for safety switches SGA/SGP/STA/STP/STM for insertion funnel



**095741** BETAETIGER-S-WQT-LN

▼ Features

- › Two safety screws included
- › Actuators with rubber bushings

- 
- ▼ Hinged actuator S top/bottom for safety switches SGA/SGP/STA/STP/STM



**095315** RADIUSBETAETIGER-S-OU-SN

▼ Features

- › Actuators made of stainless steel
- › Two safety screws included
- › For doors hinged at top and bottom

- 
- ▼ Hinged actuator S left/right for safety switches SGA/SGP/STA/STP/STM



**096838** RADIUSBETAETIGER-S-LR-SN

▼ Features

- › Actuators made of stainless steel
- › Two safety screws included
- › For doors hinged on right and left

- 
- ▼ Hinged actuator L top/bottom, for safety switches SGA/SGP/STA/STP/STM for insertion funnel



**096697** RADIUSBETAETIGER-S-OU-LN

▼ Features

- › Actuators made of stainless steel
- › Two stainless safety screws per actuator
- › For doors hinged at top and bottom

- 
- ▼ Hinged actuator L left/right, for safety switches SGA/SGP/STA/STP/STM for insertion funnel



**096844** RADIUSBETAETIGER-S-LR-LN

▼ Features

- › Actuators made of stainless steel
- › Two stainless safety screws per actuator
- › For doors hinged on right and left

- 
- ▼ Insertion funnel for safety switches SGP/STA/STP/STM/SGA



**093157** EINFUEHRTRICHTER-S

- 
- ▼ Lockout bar STA/STP/SGA/SGP/STM



**105701** SPERREINSATZ STP/STA

- ▼ Features

- › Prevents unintentional closing of the door
- › Can be secured with padlocks

---

## Bolt

- 
- ▼ Bolt BTC-ST/G... without escape release for safety switches STA, STP, SGP and SGA



**106284** BTC-ST/G-S-TH-00-X

- ▼ Features

- › Aluminum bolt
- › For doors hinged on the left or right
- › Can be locked in open position with padlocks
- › Actuator included

- 
- ▼ Bolt S-... with escape release for safety switches STA, STP, SGP and SGA



**096390** RIEGEL S-AF

- ▼ Features

- › Steel bolt
- › Lever for escape release from the danger area
- › For doors hinged on the right
- › Detent knob in open position
- › Can be locked in open position with padlocks
- › Actuator included



**096391** RIEGEL S-CF

- ▼ Features

- › Steel bolt
- › Lever for escape release from the danger area
- › For doors hinged on the left
- › Detent knob in open position
- › Can be locked in open position with padlocks
- › Actuator included

- 
- ▼ Bolt S-... for safety switches STA, STP, SGP and SGA



**096384** RIEGEL S-A

- ▼ Features

- › Steel bolt
- › For doors hinged on the right
- › Can be locked in open position with padlocks
- › Actuator included

- 
- ▼ Bolt BTC-ST/G... with escape release for safety switches STA, STP, SGP and SGA



**106285** BTC-ST/G-S-TH-01-F

▼ Features

- › Aluminum bolt
- › For doors hinged on the left or right
- › Lever for escape release from the danger area
- › Pushbutton in open position
- › Can be locked in open position with padlocks
- › Actuator included

- 
- ▼ Bolt STP-GFK for safety switches STA, STP, SGP and SGA



**098121** RIEGEL STP-GFK

▼ Features

- › Fiber glass reinforced plastic bolt
- › For doors hinged on the left or right
- › Can be locked in open position with padlocks
- › Actuator included

---

## Mounting accessories

- 
- ▼ Mounting plates EMP-SB for safety switches CTP, TP...A, STA, STP and TX



**093456** EMP-SB

▼ Features

- › For vertical and horizontal mounting of safety switches TP...A, STA, STP and TX

- 
- ▼ Mounting plates EMP-B1 for actuators for safety switches CTP, TP...A, STA, STP, TX and TZ



**093457** EMP-B1

- 
- ▼ Mounting plates EMP-B2 for actuators for safety switches CTP, TP...A, STA, STP, TX and TZ



**093458** EMP-B2

- 
- ▼ Switch bracket TP/STP GFK



**096613** SCHALTERAUFNAHME TP/STP GFK

▼ Features

- › Switch bracket made of fiber glass reinforced plastic
- › For left or right hinged doors

---

## Connection material

▼ Cable glands M20x1.5



**086233** EKPM20/06 086233

## Instructions

▼ Betriebsanleitung Sicherheitsschalter SGP...

	Doc. no.	Version	Language	Download
Betriebsanleitung Sicherheitsschalter SGP...	097700	07-08/15		2.5 MB
Manual de instrucciones Interruptores de seguridad SGP...				
Mode d'emploi pour les interrupteurs de sécurité SGP...				
Istruzioni di impiego dei finecorsa di sicurezza SGP...				
Operating Instructions Safety Switches SGP...				

## Catalogs

▼ Bezpečnostní spínače s plastovým pouzdem Sicherheitsschalter mit Kunststoffgehäuse Safety Switches with Plastic Housing Interruptores de seguridad con carcasa plástica Interrupteurs de sécurité avec boîtier plastique 塑料壳体 的安全开关











	Doc. no.	Version	Language	Download
Sicherheitsschalter mit Kunststoffgehäuse	096955	11-03/18		6.6 MB
Interrupteurs de sécurité avec boîtier plastique	100677	11-03/18		6.6 MB
Interruptores de seguridad con carcasa plástica	104855	11-03/18		6.6 MB
Bezpečnostní spínače s plastovým pouzdem	121649	11-03/18		6.6 MB
Safety Switches with Plastic Housing	096956	11-03/18		6.6 MB
塑料壳体 的安全开关	116243	11-03/18		6.2 MB

## Declaration of conformity

▼ EU prohlášení o shodě

	Doc. no.	Version	Language	Download
EU-Konformitätserklärung	2077153	25-02/17		0.3 MB
Declaración UE de conformidad				
Déclaration UE de conformité				
Dichiarazione di conformità				
EU declaration of conformity				



EU prohlášení o shodě	2077153	25-02/17		 0.5 MB
EU-overensstemmelseserklæring				
Δήλωση συμμόρφωσης της ΕΕ				
EU-vaatimustenmukaisuusvakuutus				
EU-típusbizonyítvány				
EU-conformiteitsverklaring				
Deklaracja zgodności UE				
Declaração de Conformidade UE				
Declarația de conformitate UE				
EÚ vyhlásenie o zhode				

**CAD data**

CAD data for this item on TraceParts