

ITEM 099084 SGP2E-2131ASR11

Description	Technical data	Accessories	Downloads
-------------	----------------	-------------	-----------



Features

- › Actuating head made of metal
- › Plug connector SR11

Approach direction

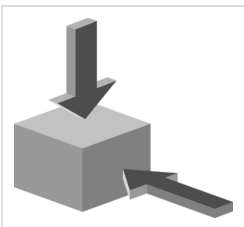

- › Figure
Horizontal and vertical
Can be adjusted in 90° steps

Switching element

2131 Slow-action switching contact 3 NC ⊕ + 1 NO

Approvals



Mechanical values and environment

Housing material	Reinforced thermoplastic
Weight	
Net	0,5 kg
Ambient temperature	-20 ... 80 °C
Degree of protection	IP65
Mechanical life	2×10^6
Contact material	Silver alloy, gold flashed
Switching principle	Slow-action switching contact
Installation position	Any
Number of door position positively driven contacts	3
Number of door position NO contacts	1
Connection	
1 x	Plug connector SR11 [1]
Approach speed	
max.	20 m/min
Actuation frequency	6700 1/h
Retention force	10 N
Extraction force	25 N
Actuating force	25 N
Insertion depth	24,5 mm

Electrical connection ratings

Rated thermal current I_{th}	4 A [2]
Utilization category according to EN 60947-5-1	
AC-15	4A 50V [3]
DC-13	4A 24V [4]
Short circuit protection according to IEC 60269-1	
(Fuse)	4A gG [5]
Rated insulation voltage U_i	50 V
Rated impulse withstand voltage U_{imp}	1,5 kV
Switching voltage	
Min. at 10mA	12 V
Switching current	
Min. at 24V	1 mA

Reliability values acc. to EN ISO 13849-1

B10_D

Monitoring of the safety guard position

3×10^6

in combination with Actuator **BETAETIGER-S-GT-SN**

Mechanical values and environment

Overtravel

5 mm

[1] 11-pole (without PE)

[2, 3, 4] $> 70^\circ\text{C} \Rightarrow 2\text{A}$

[5] $> 70^\circ\text{C} \Rightarrow 2\text{A gG}$

Dimension drawing

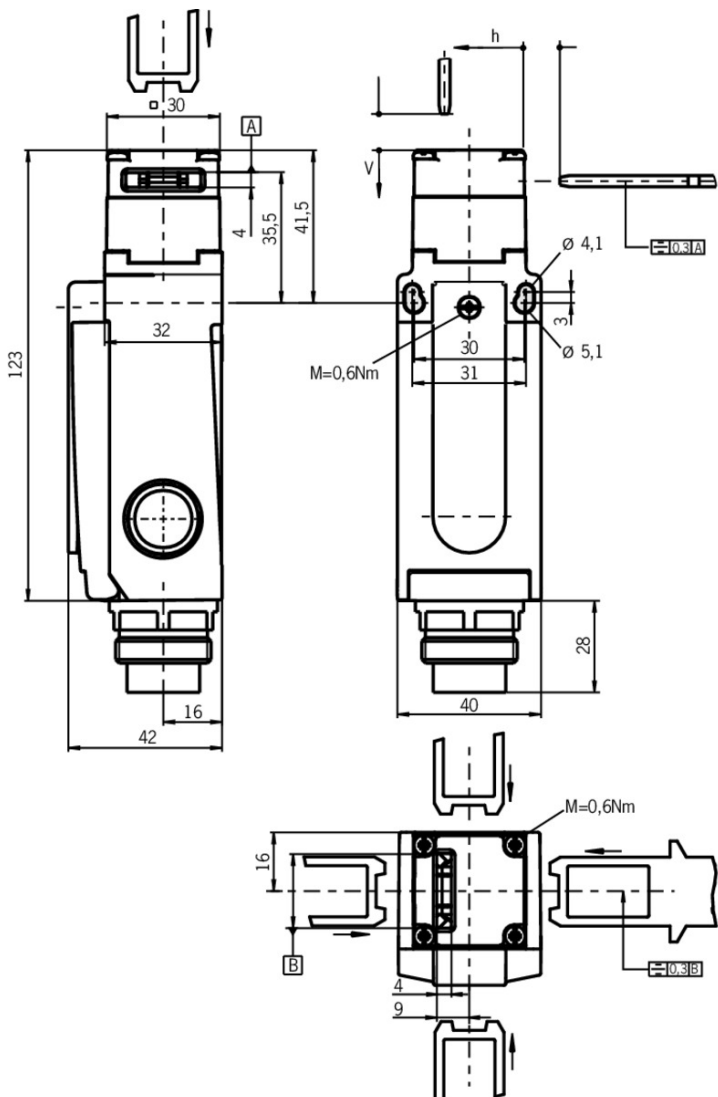

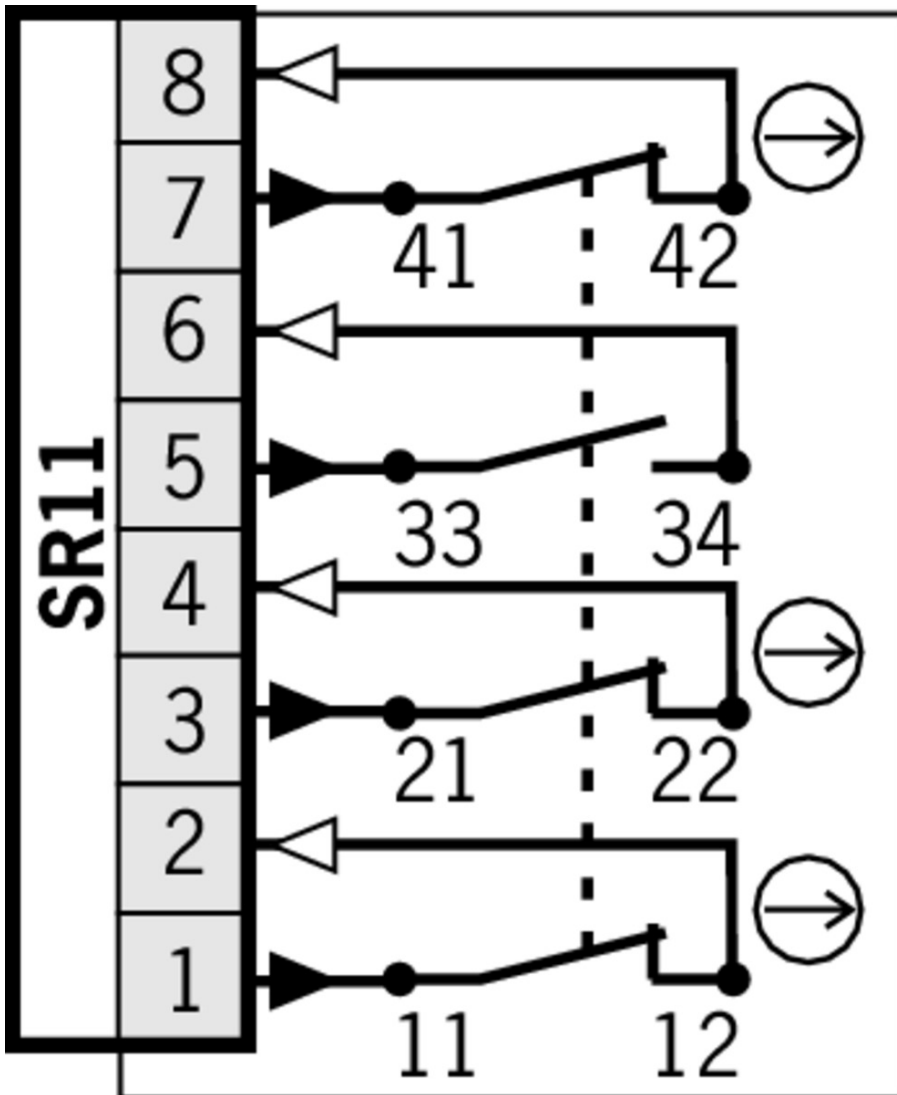

Actuator

- Actuator S for safety switches SGA/SGP/STA/STP/STM



097861 BETAETIGER-S-G-SN-C2115

- Features

- › Two safety screws included
- › Physically compatible with TP actuator P-G



095738 BETAETIGER-S-GT-SN

- Features

- › Two safety screws included
- › Actuators with rubber bushings

- Actuator S, bent, for safety switches SGA/SGP/STA/STP/STM



095740 BETAETIGER-S-WQT-SN

- Features

- › Two safety screws included

-
- ▼ Actuator L for safety switches SGA/SGP/STA/STP/STM for insertion funnel



095739 BETAETIGER-S-GT-LN

▼ Features

- › Two safety screws included
- › Actuators with rubber bushings

-
- ▼ Actuator L, bent, for safety switches SGA/SGP/STA/STP/STM for insertion funnel



095741 BETAETIGER-S-WQT-LN

▼ Features

- › Two safety screws included
- › Actuators with rubber bushings

-
- ▼ Hinged actuator S top/bottom for safety switches SGA/SGP/STA/STP/STM



095315 RADIUSBETAETIGER-S-OU-SN

▼ Features

- › Actuators made of stainless steel
- › Two safety screws included
- › For doors hinged at top and bottom

-
- ▼ Hinged actuator S left/right for safety switches SGA/SGP/STA/STP/STM



096838 RADIUSBETAETIGER-S-LR-SN

▼ Features

- › Actuators made of stainless steel
- › Two safety screws included
- › For doors hinged on right and left

-
- ▼ Hinged actuator L top/bottom, for safety switches SGA/SGP/STA/STP/STM for insertion funnel



096697 RADIUSBETAETIGER-S-OU-LN

▼ Features

- › Actuators made of stainless steel
- › Two stainless safety screws per actuator
- › For doors hinged at top and bottom

-
- ▼ Hinged actuator L left/right, for safety switches SGA/SGP/STA/STP/STM for insertion funnel



096844 RADIUSBETAETIGER-S-LR-LN

▼ Features

- › Actuators made of stainless steel
- › Two stainless safety screws per actuator
- › For doors hinged on right and left

-
- ▼ Insertion funnel for safety switches SGP/STA/STP/STM/SGA



093157 EINFUEHRTRICHTER-S

-
- ▼ Lockout bar STA/STP/SGA/SGP/STM



105701 SPERREINSATZ STP/STA

- ▼ Features

- › Prevents unintentional closing of the door
- › Can be secured with padlocks

Bolt

-
- ▼ Bolt BTC-ST/G... without escape release for safety switches STA, STP, SGP and SGA



106284 BTC-ST/G-S-TH-00-X

- ▼ Features

- › Aluminum bolt
- › For doors hinged on the left or right
- › Can be locked in open position with padlocks
- › Actuator included

-
- ▼ Bolt S-... with escape release for safety switches STA, STP, SGP and SGA



096390 RIEGEL S-AF

- ▼ Features

- › Steel bolt
- › Lever for escape release from the danger area
- › For doors hinged on the right
- › Detent knob in open position
- › Can be locked in open position with padlocks
- › Actuator included



096391 RIEGEL S-CF

- ▼ Features

- › Steel bolt
- › Lever for escape release from the danger area
- › For doors hinged on the left
- › Detent knob in open position
- › Can be locked in open position with padlocks
- › Actuator included

-
- ▼ Bolt S-... for safety switches STA, STP, SGP and SGA



096384 RIEGEL S-A

- ▼ Features

- › Steel bolt
- › For doors hinged on the right
- › Can be locked in open position with padlocks
- › Actuator included

-
- ▼ Bolt BTC-ST/G... with escape release for safety switches STA, STP, SGP and SGA



106285 BTC-ST/G-S-TH-01-F

▼ Features

- › Aluminum bolt
- › For doors hinged on the left or right
- › Lever for escape release from the danger area
- › Pushbutton in open position
- › Can be locked in open position with padlocks
- › Actuator included

-
- ▼ Bolt STP-GFK for safety switches STA, STP, SGP and SGA



098121 RIEGEL STP-GFK

▼ Features

- › Fiber glass reinforced plastic bolt
- › For doors hinged on the left or right
- › Can be locked in open position with padlocks
- › Actuator included

Mounting accessories

-
- ▼ Mounting plates EMP-SB for safety switches CTP, TP...A, STA, STP and TX



093456 EMP-SB

▼ Features

- › For vertical and horizontal mounting of safety switches TP...A, STA, STP and TX

-
- ▼ Mounting plates EMP-B1 for actuators for safety switches CTP, TP...A, STA, STP, TX and TZ



093457 EMP-B1

-
- ▼ Mounting plates EMP-B2 for actuators for safety switches CTP, TP...A, STA, STP, TX and TZ



093458 EMP-B2

-
- ▼ Switch bracket TP/STP GFK



096613 SCHALTERAUFNAHME TP/STP GFK

▼ Features

- › Switch bracket made of fiber glass reinforced plastic
- › For left or right hinged doors

Connection material

✔ Plug connector SR11 for safety switches NZ and TZ

070859 SR11EF

✔ Features

- › Crimp contacts
- › Cable optional
- › Coding shells

054773 SR11WF

✔ Features

- › Crimp contacts
- › 90° angled optional
- › Cable optional
- › Coding shells

091296 SR11AM2-M20

✔ Features

- › Crimp contacts
- › Cable optional
- › Coding shells

✔ Connection cable with plug connector SR11, 5m



077629 C-M26F12-12X1,00PU05,0-MA-077629

✔ Features

- › Female plug SR11, 11-pin + PE
- › Straight plug connector
- › PUR cable
- › Cable length 5 m
- › With flying lead

✔ Connection cable with plug connector SR11, 10m



077630 C-M26F12-12X1,00PU10,0-MA-077630

✔ Features

- › Female plug SR11, 11-pin + PE
- › Straight plug connector
- › PUR cable
- › Cable length 10 m
- › With flying lead

✔ Connection cable with plug connector SR11, 15m



077631 C-M26F12-12X1,00PU15,0-MA-077631

✔ Features

- › Female plug SR11, 11-pin + PE
- › Straight plug connector
- › PUR cable
- › Cable length 15 m
- › With flying lead

▼ Connection cable with plug connector SR11, 20m



096632 C-M26F12-12X1,0PU20,0-MA-096632

▼ Features

- › Female plug SR11, 11-pin + PE
 - › Straight plug connector
 - › PUR cable
 - › Cable length 20 m
 - › With flying lead
-

▼ Connection cable with plug connector SR11, 25m



094749 C-M26F12-12X1,0PU25,0-MA-094749

▼ Features

- › Female plug SR11, 11-pin + PE
 - › Straight plug connector
 - › PUR cable
 - › Cable length 25 m
 - › With flying lead
-

▼ Connection cable with plug connector SR11, 5m, angled



077635 C-M26F12-12X1,0PU05,0-MA-077635

▼ Features

- › Female plug SR11, 11-pin + PE
 - › Angled plug connector
 - › PUR cable
 - › Cable length 5 m
 - › With flying lead
-

▼ Connection cable with plug connector SR11, 10m, angled



077636 C-M26F12-12X1,0PU10,0-MA-077636

▼ Features

- › Female plug SR11, 11-pin + PE
 - › Angled plug connector
 - › PUR cable
 - › Cable length 10 m
 - › With flying lead
-

▼ Connection cable with plug connector SR11, 15m, angled









077637 C-M26F12-12X1,0PU15,0-MA-077637

▼ Features

- › Female plug SR11, 11-pin + PE
 - › Angled plug connector
 - › PUR cable
 - › Cable length 15 m
 - › With flying lead
-













Instructions

▼ Betriebsanleitung Sicherheitsschalter SGP...

	Doc. no.	Version	Language	Download
Betriebsanleitung Sicherheitsschalter SGP...	097700	07-08/15		 2.5 MB
Manual de instrucciones Interruptores de seguridad SGP...				
Mode d'emploi pour les interrupteurs de sécurité SGP...				
Istruzioni di impiego dei finecorsa di sicurezza SGP...				
Operating Instructions Safety Switches SGP...				

Catalogs

▼ Bezpečnostní spínače s plastovým pouzdem Sicherheitsschalter mit Kunststoffgehäuse Safety Switches with Plastic Housing Interruptores de seguridad con carcasa plástica Interrupteurs de sécurité avec boîtier plastique 塑料壳体 的安全开关

	Doc. no.	Version	Language	Download
Sicherheitsschalter mit Kunststoffgehäuse	096955	11-03/18		 6.6 MB
Interrupteurs de sécurité avec boîtier plastique	100677	11-03/18		 6.6 MB
Interruptores de seguridad con carcasa plástica	104855	11-03/18		 6.6 MB
Bezpečnostní spínače s plastovým pouzdem	121649	11-03/18		 6.6 MB
Safety Switches with Plastic Housing	096956	11-03/18		 6.6 MB
塑料壳体 的安全开关	116243	11-03/18		 6.2 MB

Declaration of conformity

▼ EU prohlášení o shodě

	Doc. no.	Version	Language	Download
EU-Konformitätserklärung Declaración UE de conformidad Déclaration UE de conformité Dichiarazione di conformità EU declaration of conformity	2077153	25-02/17	    	 0.3 MB
EU prohlášení o shodě EU-overensstemmelseserklæring Δήλωση συμμόρφωσης της ΕΕ EU-vaatimustenmukaisuusvakuutus EU-típusbizonyítvány EU-conformiteitsverklaring Deklaracja zgodności UE Declaração de Conformidade UE Declarația de conformitate UE EÚ vyhlásenie o zhode	2077153	25-02/17	         	 0.5 MB

CAD data

CAD data for this item on TraceParts