

ITEM 085180 TZ2LE024RC18VAB-C1826

Description	Technical data	Accessories	Downloads
-------------	----------------	-------------	-----------



Features

- › Auxiliary release on the front
- › Two LED indicators, red and green
- › Plug connector M23 (RC18)
- › Actuating head fitted left

Approach direction



- › Figure
Horizontal
Can be adjusted in 90° steps

Solenoid operating voltage and LED function display

- › 24 V AC/DC -15%, +10%

Guard locking type

TZ2 Open-circuit current principle, guard locking by applying voltage to the solenoid. Release by spring force.

Switching elements

SK For monitoring the door/actuator position

ÜK For monitoring the guard locking (built-in solenoid)

2131H Slow-action switching contact 3 NC \ominus + 1 NO

3131H Slow-action switching contact 2 NC \ominus + 2 NO

Auxiliary release

Is used for releasing the guard locking with the aid of a tool. Sealing can be fitted to protect against tampering. Lead seal kit and tool included (already pre-assembled on versions with plug connectors).

Approvals



Mechanical values and environment

Housing material	Anodized die-cast alloy
Weight	Net 1,2 kg
Ambient temperature	-25 ... 80 °C
Degree of protection	IP65
Mechanical life	1 x 10 ⁶
Contact material	Silver alloy, gold flashed
Switching principle	Slow-action switching contact
Installation position	Any
Number of door position positively driven contacts	2
Number of door position NO contacts	1
Number of guard lock monitoring positively driven contacts	2
Number of guard lock monitoring NO contacts	2
Connection	1 x Plug connector RC18 [1]
Approach speed	max.20 m/min
Actuation frequency	1200 1/h
Guard locking principle	Open-circuit current principle
Locking force F _{max}	2000 N
Locking force F _{Zh}	1500 N

Retention force	10 N
Extraction force	30 N
Actuating force	35 N
Insertion depth	min.52 mm
Cover lid	Black

Electrical connection ratings

Rated thermal current I_{th}	4 A [2]
Utilization category according to EN 60947-5-1	AC-15 4A 110V [3] DC-13 4A 24V [4]
Solenoid operating voltage	AC/DC 24 V -15% ... +10%
Short circuit protection according to IEC 60269-1	(Fuse) 4A gG [5]
Rated insulation voltage U_i	110 V
Rated impulse withstand voltage U_{imp}	1,5 kV
Switching voltage	Min. at 10mA 12 V
Switching current	Min. at 24V 1 mA
Power consumption	10 W
Solenoid duty cycle	100 %
LED indicator	Operating voltage corresponds to the solenoid voltage [6]

Miscellaneous

C number	C1826	Special wiring
----------	-------	----------------

Reliability values acc. to EN ISO 13849-1

	Monitoring of guard locking and the safety guard position	
B10 _D	3×10^6	

in combination with Actuator BETAETIGER-Z-G

Mechanical values and environment

Overtravel	4 mm
------------	------

in combination with Actuator BETAETIGER-Z-GN

Mechanical values and environment

Overtravel

16 mm

- [1] 18-pin + PE
- [2, 3, 4] >70°C => 2A
- [5] > 70°C => 2A gG
- [6] 2 LEDs; green, red

Dimension drawing

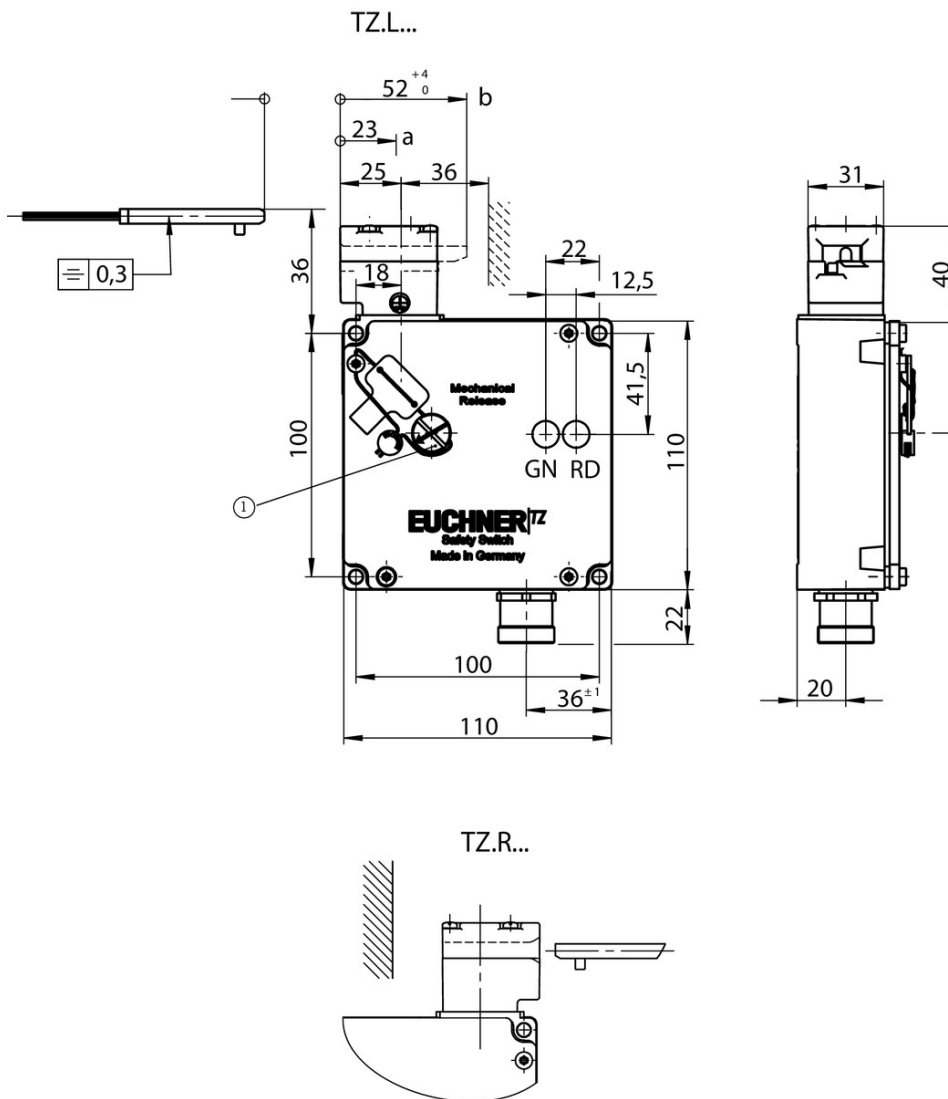

Legende

- 1 Auxiliary release

SK:2131H/ÜK:3131HRC18-C1826

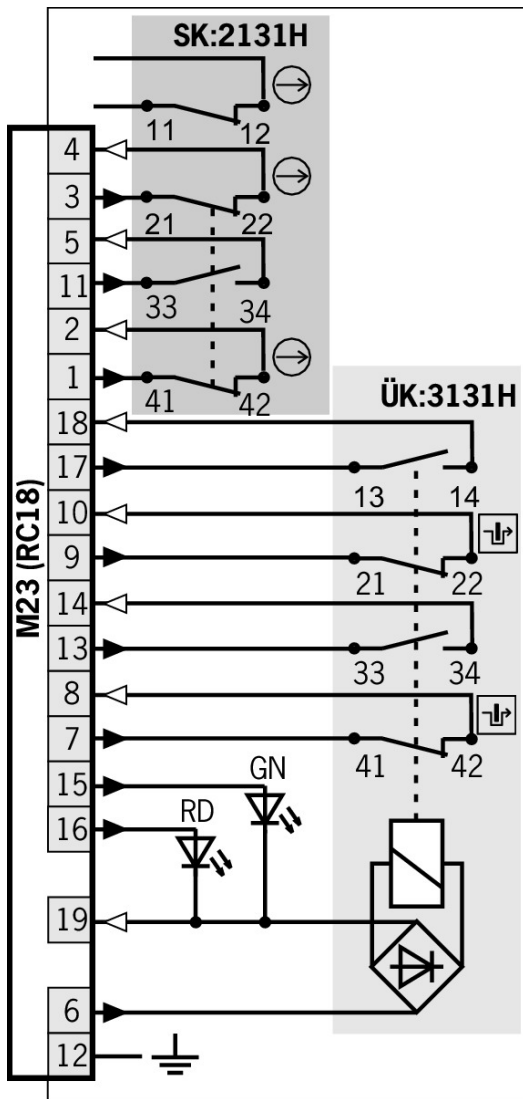

Legende

- Solenoid monitoring
- Door monitoring

Switching functions

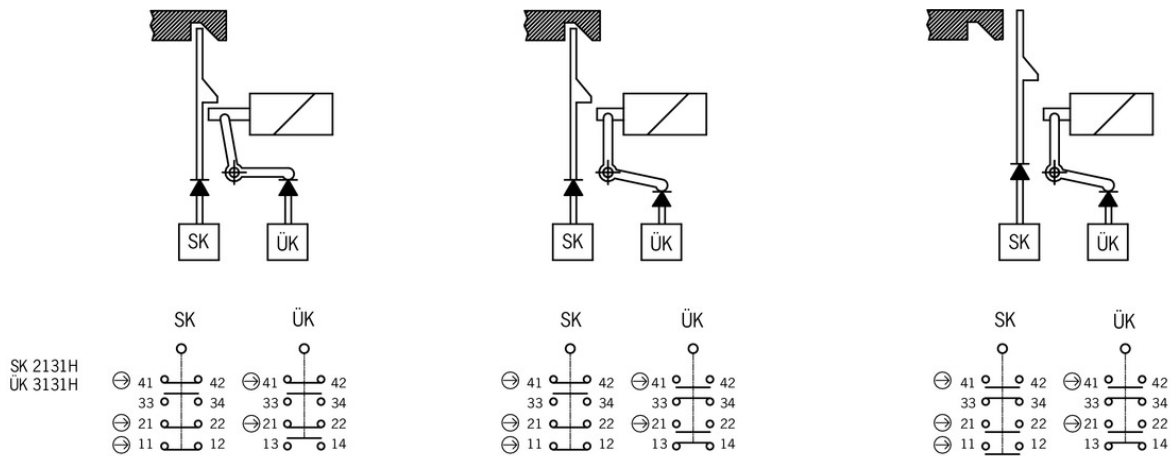

Actuator

Actuators for safety switches NZ.VZ, NZ.VZ.VS and TZ



074411 BETAETIGER-Z-G/V25

Features

- › Two stainless safety screws per actuator
- › Packaging unit 25 pieces



097436 BETAETIGER-Z-GME

Features

- › Made of solid stainless steel
- › Two stainless safety screws per actuator



072251 BETAETIGER-Z-GN

Features

- › Two stainless safety screws per actuator



016849 BETAETIGER-Z-G

Features

- › Two stainless safety screws per actuator

Hinged actuator right for safety switches NZ.VZ, NZ.VZ.VS and TZ



024299 RADIUSBETAETIGER-Z-R

Features

- › Two stainless safety screws per actuator



100406 RADIUSBETAETIGER-Z-R-C2194

Features

- › Two stainless safety screws per actuator
- › Smaller door radii



074412 RADIUSBETAETIGER-Z-R/V25

▼ Features

- › Two stainless safety screws per actuator
 - › Packaging unit 25 pieces
-

▼ Hinged actuator left for safety switches NZ.VZ, NZ.VZ.VS and TZ



074413 RADIUSBETAETIGER-Z-L/V25

▼ Features

- › Two stainless safety screws per actuator
 - › Packaging unit 25 pieces
-



024298 RADIUSBETAETIGER-Z-L

▼ Features

- › Two stainless safety screws per actuator
-



100407 RADIUSBETAETIGER-Z-L-C2194

▼ Features

- › Two stainless safety screws per actuator
 - › Smaller door radii
-

▼ Hinged actuator top for safety switches NZ.VZ, NZ.VZ.VS and TZ



074415 RADIUSBETAETIGER-Z-O/V25

▼ Features

- › Two stainless safety screws per actuator
 - › Packaging unit 25 pieces
-



057950 RADIUSBETAETIGER-Z-O

▼ Features

- › Two stainless safety screws per actuator
-

▼ Hinged actuator bottom for safety switches NZ.VZ, NZ.VZ.VS and TZ



074414 RADIUSBETAETIGER-Z-U/V25

▼ Features

- › Two stainless safety screws per actuator
 - › Packaging unit 25 pieces
-



048850 RADIUSBETAETIGER-Z-U

▼ Features

- › Two stainless safety screws per actuator
-

Bolt

▼ Bolt TZ-C... for safety switches TZ



079799 RIEGEL TZ-C-NIRO

✓ Features

- › Stainless steel bolt
- › For doors hinged on the left
- › Can be locked in open position with padlocks
- › Actuator and switch bracket included



057737 RIEGEL TZ-C

✓ Features

- › Steel bolt
- › For doors hinged on the left
- › Can be locked in open position with padlocks
- › Actuator and switch bracket included



096058 RIEGEL TZ-C-NIRO-C2101

✓ Features

- › Stainless steel bolt
- › For doors hinged on the left
- › Can be locked in open position with padlocks
- › Actuator and switch bracket included



117194 RIEGEL TZ-C-NIRO-C2392

✓ Features

- › Stainless steel bolt
- › For doors hinged on the left
- › Can be locked in open position with padlocks
- › Actuator and switch bracket included

✓ Bolts NZ/TZ-S1 and NZ/TZ-S2 for safety switches NZ.VZ, NZ.VZ.VS and TZ



028359 RIEGEL NZ/TZ-S2

✓ Features

- › Aluminum bolt
- › For doors hinged on the left or right. Cone grip top.
- › Spring catch in open position
- › Can be locked in open position with padlocks
- › Actuator included



028357 RIEGEL NZ/TZ-S1

✓ Features

- › Aluminum bolt
- › For doors hinged on the left or right. Cone grip bottom.
- › Spring catch in open position
- › Can be locked in open position with padlocks
- › Actuator included

✓ Bolt BTC-TZ00... without escape release for safety switch TZ



106280 BTC-TZ00-C-TH-00-X

✓ Features

- › Aluminum bolt

- › For doors hinged on the left
 - › Can be locked in open position with padlocks
 - › Actuator included
-

Connection material

- ▼ Connection cable with plug connector M23 with option C1825, 3m, angled



092909 C-M23F19-19XDIFPU03,0-MA-092909

▼ Features

- › M23 plug connector, 18-pin + PE
 - › Angled plug connector
 - › Cable exit A (right)
 - › PUR cable
 - › Cable length 3 m
 - › With flying lead
 - › Cores color-coded
-



092908 C-M23F19-19XDIFPU03,0-MA-092908

▼ Features

- › M23 plug connector, 18-pin + PE
 - › Angled plug connector
 - › Cable exit C (left)
 - › PUR cable
 - › Cable length 3 m
 - › With flying lead
 - › Cores color-coded
-

- ▼ Connection cable with plug connector M23 with option C1825, 10m, angled



092901 C-M23F19-19XDIFPU10,0-MA-092901

▼ Features

- › M23 plug connector, 18-pin + PE
 - › Angled plug connector
 - › Cable exit C (left)
 - › PUR cable
 - › Cable length 10 m
 - › With flying lead
 - › Cores color-coded
-



092902 C-M23F19-19XDIFPU10,0-MA-092902

▼ Features

- › M23 plug connector, 18-pin + PE
 - › Angled plug connector
 - › Cable exit A (right)
 - › PUR cable
 - › Cable length 10 m
 - › With flying lead
 - › Cores color-coded
-

- ▼ Connection cable with plug connector M23 with option C1825, 6m, angled



085194 C-M23F19-19XDIFPU06,0-MA-085194

▼ Features

- › M23 plug connector, 18-pin + PE
- › Angled plug connector
- › Cable exit A (right)
- › PUR cable
- › Cable length 6 m
- › With flying lead
- › Cores color-coded



077018 C-M23F19-19XDIFPU06,0-MA-077018

▼ Features

- › M23 plug connector, 18-pin + PE
- › Angled plug connector
- › Cable exit C (left)
- › PUR cable
- › Cable length 6 m
- › With flying lead
- › Cores color-coded

▼ Connection cable with plug connector M23 with option C1825, 20m, angled



092910 C-M23F19-19XDIFPU20,0-MA-092910

▼ Features

- › M23 plug connector, 18-pin + PE
- › Angled plug connector
- › Cable exit C (left)
- › PUR cable
- › Cable length 20 m
- › With flying lead
- › Cores color-coded



092911 C-M23F19-19XDIFPU20,0-MA-092911

▼ Features

- › M23 plug connector, 18-pin + PE
- › Angled plug connector
- › Cable exit A (right)
- › PUR cable
- › Cable length 20 m
- › With flying lead
- › Cores color-coded

▼ Female connector RC18 angled with option C1825



077026 RC18WF-C1825

▼ Features

- › Plug connector M23, angled
- › Number of pins: 19-pin with screen bonding clamp

▼ Connection cable with plug connector M23 with option C1825, 15m, straight

077016 C-M23F19-19XDIFPU15,0-MA-077016



- ▼ Features
 - › M23 plug connector, 18-pin + PE
 - › Straight plug connector
 - › PUR cable
 - › Cable length 15 m
 - › With flying lead
 - › Cores color-coded
-

- ▼ Connection cable with plug connector M23 with option C1825, 20m, straight



092726 C-M23F19-19XDIFPU20,0-MA-092726

- ▼ Features
 - › M23 plug connector, 18-pin + PE
 - › Straight plug connector
 - › PUR cable
 - › Cable length 20 m
 - › With flying lead
 - › Cores color-coded
-

- ▼ Connection cable with plug connector M23 with option C1825, 25m, straight



092727 C-M23F19-19XDIFPU25,0-MA-092727

- ▼ Features
 - › M23 plug connector, 18-pin + PE
 - › Straight plug connector
 - › PUR cable
 - › Cable length 25 m
 - › With flying lead
 - › Cores color-coded
-

- ▼ Connection cable with plug connector M23 with option C1825, 1.5m, angled



092906 C-M23F19-19XDIFPU01,5-MA-092906

- ▼ Features
 - › M23 plug connector, 18-pin + PE
 - › Angled plug connector
 - › Cable exit C (left)
 - › PUR cable
 - › Cable length 1.5 m
 - › With flying lead
 - › Cores color-coded
-



092907 C-M23F19-19XDIFPU01,5-MA-092907

- ▼ Features
 - › M23 plug connector, 18-pin + PE
 - › Angled plug connector
 - › Cable exit A (right)
 - › PUR cable
 - › Cable length 1.5 m
 - › With flying lead
 - › Cores color-coded
-

- ▼ Connection cable with plug connector M23 with option C1825, 8m, angled



077019 C-M23F19-19XDIFPU08,0-MA-077019

▼ Features

- › RC18 plug connector, 18-pin + PE
- › Angled plug connector
- › Cable exit C (left)
- › PUR cable
- › Cable length 8 m
- › With flying lead
- › Cores color-coded



085195 C-M23F19-19XDIFPU08,0-MA-085195

▼ Features

- › M23 plug connector, 18-pin + PE
- › Angled plug connector
- › Cable exit A (right)
- › PUR cable
- › Cable length 8 m
- › With flying lead
- › Cores color-coded

- ▼ Connection cable with plug connector M23 with option C1825, 8m, straight



077015 C-M23F19-19XDIFPU08,0-MA-077015

▼ Features

- › M23 plug connector, 18-pin + PE
- › Straight plug connector
- › PUR cable
- › Cable length 8 m
- › With flying lead
- › Cores color-coded

- ▼ Female plug RC18 straight with option C1825



077025 RC18EF-C1825

▼ Features

- › Plug connector M23, straight
- › Number of pins: 19-pin with screen bonding clamp

- ▼ Female plug RC18 angled



074617 RC18WF

▼ Features

- › Plug connector M23, angled
- › Number of pins: 19-pin with screen bonding clamp

- ▼ Connection cable with plug connector M23 with option C1825, 15m, angled



085196 C-M23F19-19XDIFPU15,0-MA-085196

▼ Features

- › M23 plug connector, 18-pin + PE

- › Angled plug connector
- › Cable exit A (right)
- › PUR cable
- › Cable length 15 m
- › With flying lead
- › Cores color-coded



077020 C-M23F19-19XDIFPU15,0-MA-077020

▣ Features

- › M23 plug connector, 18-pin + PE
- › Angled plug connector
- › Cable exit C (left)
- › PUR cable
- › Cable length 15 m
- › With flying lead
- › Cores color-coded

▣ Connection cable with plug connector M23 with option C1825, 25m, angled



092913 C-M23F19-19XDIFPU25,0-MA-092913

▣ Features

- › M23 plug connector, 18-pin + PE
- › Angled plug connector
- › Cable exit A (right)
- › PUR cable
- › Cable length 25 m
- › With flying lead
- › Cores color-coded



092912 C-M23F19-19XDIFPU25,0-MA-092912

▣ Features

- › M23 plug connector, 18-pin + PE
- › Angled plug connector
- › Cable exit C (left)
- › PUR cable
- › Cable length 25 m
- › With flying lead
- › Cores color-coded

▣ Connection cable with plug connector M23, 19-pin, 25m, straight



110307 C-M23F19-19XDIFPU25,0-MA-110307

▣ Features

- › M23 female plug, 19-pin
- › Straight plug connector
- › PUR cable
- › Cable length 25 m
- › With flying lead
- › Cores numbered, black

▣ Female plug RC18 straight

074616 RC18EF



- ▼ Features
 - › Plug connector M23, straight
 - › Number of pins: 19-pin with screen bonding clamp
-

- ▼ Connection cable with plug connector M23 with option C1825, 1.5m, straight



092761 C-M23F19-19XDIFPU01,5-MA-092761

- ▼ Features
 - › M23 plug connector, 18-pin + PE
 - › Straight plug connector
 - › PUR cable
 - › Cable length 1.5 m
 - › With flying lead
 - › Cores color-coded
-

- ▼ Connection cable with plug connector M23 with option C1825, 6m, straight



077014 C-M23F19-19XDIFPU06,0-MA-077014

- ▼ Features
 - › M23 plug connector, 18-pin + PE
 - › Straight plug connector
 - › PUR cable
 - › Cable length 6 m
 - › With flying lead
 - › Cores color-coded
-

- ▼ Connection cable with plug connector M23 with option C1825, 10m, straight



092898 C-M23F19-19XDIFPU10,0-MA-092898

- ▼ Features
 - › M23 plug connector, 18-pin + PE
 - › Straight plug connector
 - › PUR cable
 - › Cable length 10 m
 - › With flying lead
 - › Cores color-coded
-

- ▼ Connection cable with plug connector M23 with option C1825, 30m, straight



095993 C-M23F19-19XDIFPU30,0-MA-095993

- ▼ Features
 - › M23 plug connector, 18-pin + PE
 - › Straight plug connector
 - › PUR cable
 - › Cable length 30 m
 - › With flying lead
 - › Cores color-coded
-

- ▼ Connection cable with plug connector M23, 19-pin, 1.5m, straight



110301 C-M23F19-19XDIFPU01,5-MA-110301

- ▼ Features

- › M23 female plug, 19-pin
 - › Straight plug connector
 - › PUR cable
 - › Cable length 1.5 m
 - › With flying lead
 - › Cores numbered, black
-

▼ Connection cable with plug connector M23, 19-pin, 3m, straight



110302 C-M23F19-19XDIFPU03,0-MA-110302

▼ Features

- › M23 female plug, 19-pin
 - › Straight plug connector
 - › PUR cable
 - › Cable length 3 m
 - › With flying lead
 - › Cores numbered, black
-

▼ Connection cable with plug connector M23, 19-pin, 6m, straight



110303 C-M23F19-19XDIFPU06,0-MA-110303

▼ Features

- › M23 female plug, 19-pin
 - › Straight plug connector
 - › PUR cable
 - › Cable length 6 m
 - › With flying lead
 - › Cores numbered, black
-

▼ Connection cable with plug connector M23, 19-pin, 10m, straight



110304 C-M23F19-19XDIFPU10,0-MA-110304

▼ Features

- › M23 female plug, 19-pin
 - › Straight plug connector
 - › PUR cable
 - › Cable length 10 m
 - › With flying lead
 - › Cores numbered, black
-

▼ Connection cable with plug connector M23, 19-pin, 20m, straight



110306 C-M23F19-19XDIFPU20,0-MA-110306

▼ Features

- › M23 female plug, 19-pin
 - › Straight plug connector
 - › PUR cable
 - › Cable length 20 m
 - › With flying lead
 - › Cores numbered, black
-

▼ Connection cable with plug connector M23, 19-pin, 15m, straight



110305 C-M23F19-19XDIFPU15,0-MA-110305

▼ Features

- › M23 female plug, 19-pin
- › Straight plug connector
- › PUR cable
- › Cable length 15 m
- › With flying lead
- › Cores numbered, black

Mounting accessories

- ▼ Mounting plates EMP-B2 for actuators for safety switches CTP, TP...A, STA, STP, TX and TZ



093458 EMP-B2

- ▼ Mounting plates EMP-B1 for actuators for safety switches CTP, TP...A, STA, STP, TX and TZ



093457 EMP-B1

- ▼ Mounting plates EMP-SA for safety switches TZ



094401 EMP-SA

▼ Features

- › For vertical and horizontal mounting of safety switch TZ

- ▼ Safety screws for actuators, M5 x 10

073455 M5X10-NIRO/V100 NZ/TZ

▼ Features

- › Safety screws M5 x 10
- › Packaging unit 100 pieces

- ▼ Safety screws for actuators, M5 x 16

073456 M5X16/V100

▼ Features

- › Safety screws M5 x 16
- › Packaging unit 100 pieces

- ▼ Safety screws M5 x 25

073457 M5X25/V100

▼ Features

- › Safety screws M5 x 25
- › Packaging unit 100 pieces

Function expansion

☑ Lockout mechanism NZ.VZ/TZ, 3 holes



046730 SPERREINSATZ-Z-046730

☑ Features

- › Prevents unintentional closing of the door
 - › Can be secured with padlocks
-



091305 SPERREINSATZ MIT KETTE

☑ Features

- › Prevents unintentional closing of the door
 - › Can be secured with padlocks
-

☑ Protective plate NZ.VZ/TZ

059136 SCHUTZBLECH NZ/TZ

☑ Lockout mechanism NZ.VZ/TZ, 5 holes

086538 SPERREINSATZ-Z-086538

☑ Features

- › Prevents unintentional closing of the door
 - › Can be secured with padlocks
-

☑ Adapter NZ/TZ 45/30



079033 ADAPTER NZ/TZ 45/30

☑ Features

- › The adapter NZ/TZ 45/30 is used to compensate for different profiles, doors/frame 45/30
-

Spare parts

☑ Lead seal kit

048257 PLOMBENSATZ TZ













Instructions

☑ Betriebsanleitung Sicherheitsschalter TZ...

Betriebsanleitung Sicherheitsschalter TZ... Operating Instructions TZ... Safety Switch Manual de instrucciones del interruptor de seguridad TZ... Mode d'emploi Interrupteur de sécurité TZ... Istruzioni di impiego dei finecorsa di sicurezza TZ...	2088062	09-05/18	    	 6.9 MB
Instrukcja obsługi wyłącznika bezpieczeństwa TZ...	2088062	09-05/18		 1.8 MB
Manual de instruções da chave de segurança TZ...	2088062	09-05/18		 1.5 MB
Руководство по эксплуатации предохранительных выключателей TZ...	2088062	09-05/18		 1.9 MB
Návod na obsluhu – bezpečnostný spínač TZ...	2088062	09-05/18		 1.8 MB
使用说明书安全开关 TZ...	2088062	09-05/18		 1.6 MB

Catalogs

- ✓ Sicherheitsschalter mit Metallgehäuse Safety Switches with Metal Housing Bezpečnostní spínače s kovovým pouzdem Interrupteurs de sécurité avec boîtier métallique 金属壳体的安全开关 Interruptores de seguridad con carcasa metálica

	Doc. no.	Version	Language	Download
Sicherheitsschalter mit Metallgehäuse	100319	11-03/18		 7.9 MB
Interrupteurs de sécurité avec boîtier métallique	100676	11-03/18		 7.9 MB
Interruptores de seguridad con carcasa metálica	104856	11-03/18		 14.0 MB
Safety Switches with Metal Housing	100369	11-03/18		 7.9 MB
Bezpečnostní spínače s kovovým pouzdem	121650	11-03/18		 7.9 MB
金属壳体的安全开关	102453	11-03/18		 8.2 MB

Declaration of conformity

- ✓ EU prohlášení o shodě

	Doc. no.	Version	Language	Download
EU-Konformitätserklärung Declaración UE de conformidad Déclaration UE de conformité Dichiarazione di conformità EU declaration of conformity	2077153	25-02/17	    	 0.3 MB
EU prohlášení o shodě EU-overensstemmelseserklæring Δήλωση συμμόρφωσης της ΕΕ EU-vaatimustenmukaisuusvakuutus EU-típusbizonyítvány EU-conformiteitsverklaring Deklaracja zgodności UE Declaração de Conformidade UE Declarația de conformitate UE EÚ vyhlásenie o zhode	2077153	25-02/17	         	 0.5 MB

CAD data

