

## ITEM 088024 TZ1RE110MVAB

Description	Technical data	Accessories	Downloads
-------------	----------------	-------------	-----------



### Features

- › Auxiliary release on the front
- › Two LED indicators, red and green
- › Actuating head fitted right

### Approach direction

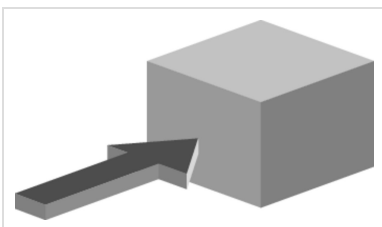

- › Figure  
Horizontal  
Can be adjusted in 90° steps

### Solenoid operating voltage and LED function display

- › 110 V AC -15%, +10%

## Guard locking type

**TZ1** Closed-circuit current principle, guard locking by spring force. Release by applying voltage to the solenoid.

## Switching elements

**SK** For monitoring the door/actuator position

**ÜK** For monitoring the guard locking (built-in solenoid)

**2131H** Slow-action switching contact 3 NC $\ominus$  + 1 NO

**3131H** Slow-action switching contact 2 NC $\ominus$  + 2 NO

## Auxiliary release

Is used for releasing the guard locking with the aid of a tool. Sealing can be fitted to protect against tampering. Lead seal kit and tool included (already pre-assembled on versions with plug connectors).

## Approvals



## Mechanical values and environment

Housing material	Anodized die-cast alloy
Weight	Net 1,2 kg
Ambient temperature	-25 ... 80 °C
Degree of protection	IP67
Mechanical life	1 x 10 <sup>6</sup>
Contact material	Silver alloy, gold flashed
Switching principle	Slow-action switching contact
Installation position	Any
Number of door position positively driven contacts	3
Number of door position NO contacts	1
Number of guard lock monitoring positively driven contacts	2
Number of guard lock monitoring NO contacts	2
Connection	1 x M20 x 1.5
Approach speed	max.20 m/min
Actuation frequency	1200 1/h
Guard locking principle	Closed-circuit current principle
Locking force F <sub>max</sub>	2000 N
Locking force F <sub>Zh</sub>	1500 N

Retention force	10 N
Extraction force	30 N
Actuating force	35 N
Insertion depth	min.52 mm
Cover lid	Black

### Electrical connection ratings

Rated thermal current $I_{th}$	4 A [1]
Utilization category according to EN 60947-5-1	AC-15 4A 230V [2] DC-13 4A 24V [3]
Solenoid operating voltage	AC 110 V -15% ... +10%
Short circuit protection according to IEC 60269-1	(Fuse) 4A gG [4]
Rated insulation voltage $U_i$	250 V
Rated impulse withstand voltage $U_{imp}$	2,5 kV
Switching voltage	Min. at 10mA 12 V
Switching current	Min. at 24V 1 mA
Power consumption	10 W
Solenoid duty cycle	100 %
Connection cross-section	0,34 ... 1,5 mm <sup>2</sup>
LED indicator	Operating voltage corresponds to the solenoid voltage [5]

### Reliability values acc. to EN ISO 13849-1

	Control of the guard locking
Category	Depending on external control of guard locking
Performance Level	Depending on external control of guard locking
PFH <sub>D</sub>	Depending on external control of guard locking
	Monitoring of guard locking and the safety guard position
B10 <sub>D</sub>	3 x 10 <sup>6</sup>

in combination with Actuator BETAETIGER-Z-G

### Mechanical values and environment

Overtravel	4 mm
------------	------

in combination with Actuator BETAETIGER-Z-GN

## Mechanical values and environment

Overtravel

16 mm

[1, 2, 3] >70°C => 2A

[4] > 70°C => 2A gG

[5] 2 LEDs; green, red

## Dimension drawing

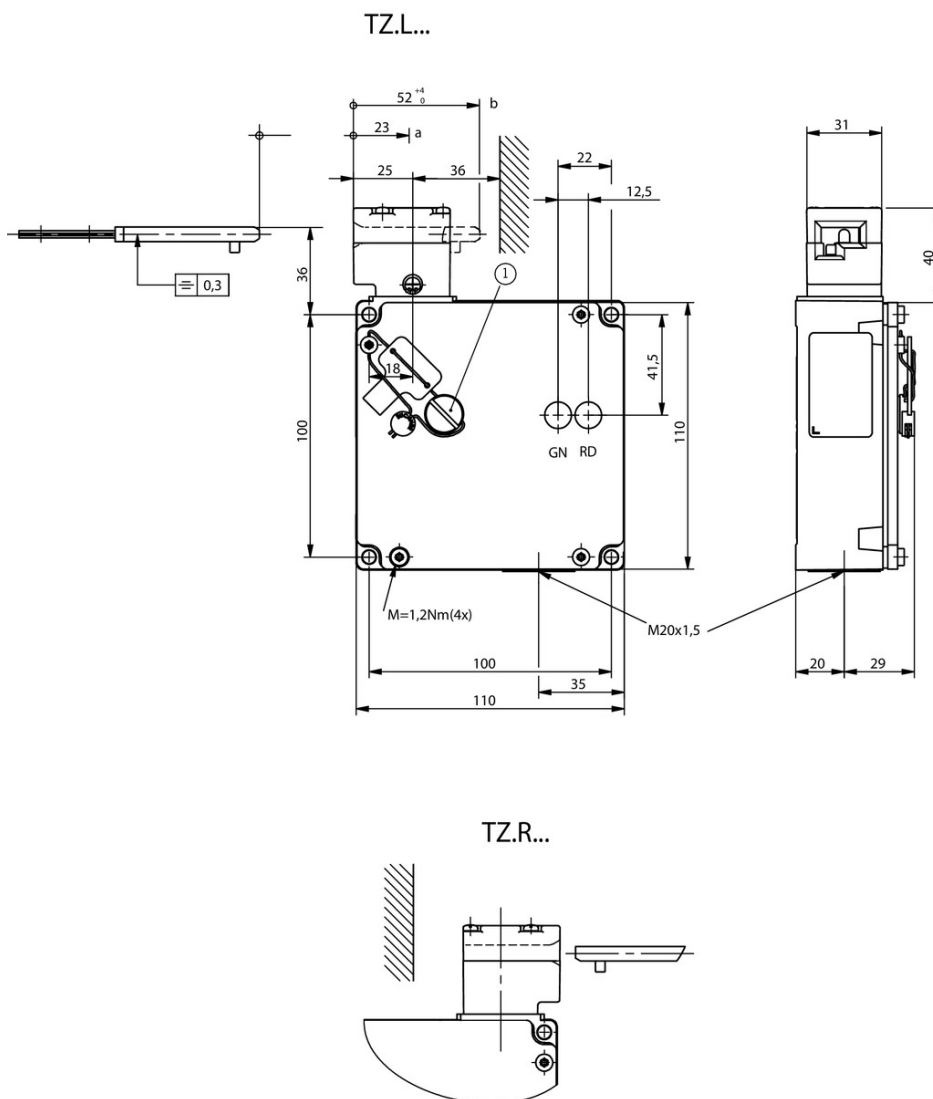

## Legende

1 Auxiliary release

**SK: 2131H / ÜK: 3131H**

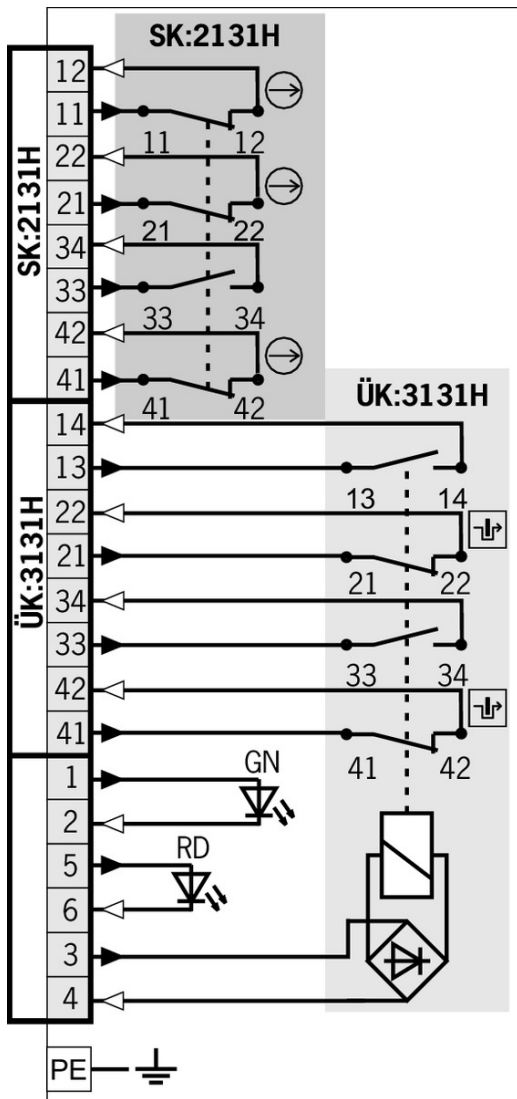

**Legende**

- Solenoid monitoring
- Door monitoring

## Switching functions

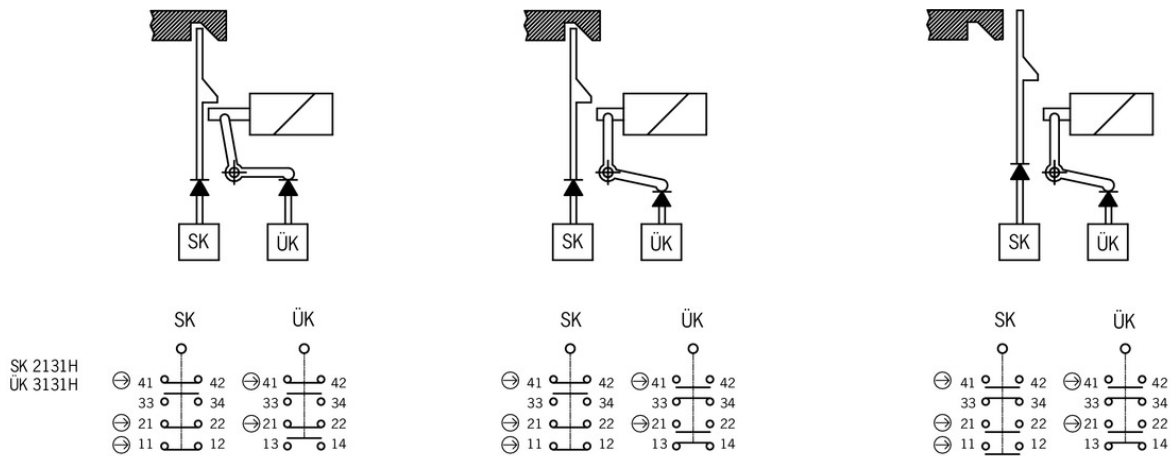

## Bolt

- ✓ Bolt BTC-TZ00... without escape release for safety switch TZ



### 106278 BTC-TZ00-A-TH-00-X

#### ✓ Features

- › Aluminum bolt
- › For doors hinged on the right
- › Can be locked in open position with padlocks
- › Actuator included

- ✓ Bolt TZ-A... for safety switches TZ



### 079798 RIEGEL TZ-A-NIRO

#### ✓ Features

- › Stainless steel bolt
- › For doors hinged on the right
- › Can be locked in open position with padlocks
- › Actuator and switch bracket included



### 096057 RIEGEL TZ-A-NIRO-C2101

#### ✓ Features

- › Stainless steel bolt
- › For doors hinged on the right
- › Can be locked in open position with padlocks
- › Actuator and switch bracket included



### 057736 RIEGEL TZ-A

#### ✓ Features

- › Steel bolt
- › For doors hinged on the right
- › Can be locked in open position with padlocks
- › Actuator and switch bracket included

- ▼ Bolts NZ/TZ-S1 and NZ/TZ-S2 for safety switches NZ.VZ, NZ.VZ.VS and TZ



#### **028357** RIEGEL NZ/TZ-S1

##### ▼ Features

- › Aluminum bolt
- › For doors hinged on the left or right. Cone grip bottom.
- › Spring catch in open position
- › Can be locked in open position with padlocks
- › Actuator included



#### **028359** RIEGEL NZ/TZ-S2

##### ▼ Features

- › Aluminum bolt
- › For doors hinged on the left or right. Cone grip top.
- › Spring catch in open position
- › Can be locked in open position with padlocks
- › Actuator included

## Spare parts

- ▼ Lead seal kit

#### **048257** PLOMBENSATZ TZ

## Function expansion

- ▼ Lockout mechanism NZ.VZ/TZ, 5 holes

#### **086538** SPERREINSATZ-Z-086538

##### ▼ Features

- › Prevents unintentional closing of the door
- › Can be secured with padlocks

- ▼ Protective plate NZ.VZ/TZ

#### **059136** SCHUTZBLECH NZ/TZ

- ▼ Lockout mechanism NZ.VZ/TZ, 3 holes



#### **091305** SPERREINSATZ MIT KETTE

##### ▼ Features

- › Prevents unintentional closing of the door
- › Can be secured with padlocks



#### **046730** SPERREINSATZ-Z-046730

##### ▼ Features

- › Prevents unintentional closing of the door

- › Can be secured with padlocks

---

▼ Adapter NZ/TZ 45/30



**079033** ADAPTER NZ/TZ 45/30

▼ Features

- › The adapter NZ/TZ 45/30 is used to compensate for different profiles, doors/frame 45/30

---

## Actuator

▼ Hinged actuator left for safety switches NZ.VZ, NZ.VZ.VS and TZ



**100407** RADIUSBETAETIGER-Z-L-C2194

▼ Features

- › Two stainless safety screws per actuator
- › Smaller door radii



**024298** RADIUSBETAETIGER-Z-L

▼ Features

- › Two stainless safety screws per actuator



**074413** RADIUSBETAETIGER-Z-L/V25

▼ Features

- › Two stainless safety screws per actuator
- › Packaging unit 25 pieces

▼ Hinged actuator top for safety switches NZ.VZ, NZ.VZ.VS and TZ



**057950** RADIUSBETAETIGER-Z-O

▼ Features

- › Two stainless safety screws per actuator



**074415** RADIUSBETAETIGER-Z-O/V25

▼ Features

- › Two stainless safety screws per actuator
- › Packaging unit 25 pieces

▼ Hinged actuator bottom for safety switches NZ.VZ, NZ.VZ.VS and TZ



**074414** RADIUSBETAETIGER-Z-U/V25

▼ Features

- › Two stainless safety screws per actuator
- › Packaging unit 25 pieces



**048850** RADIUSBETAETIGER-Z-U

▼ Features

- › Two stainless safety screws per actuator

---

▼ Actuators for safety switches NZ.VZ, NZ.VZ.VS and TZ



**072251** BETAETIGER-Z-GN

▼ Features

- › Two stainless safety screws per actuator



**097436** BETAETIGER-Z-GME

▼ Features

- › Made of solid stainless steel
- › Two stainless safety screws per actuator



**074411** BETAETIGER-Z-G/V25

▼ Features

- › Two stainless safety screws per actuator
- › Packaging unit 25 pieces



**016849** BETAETIGER-Z-G

▼ Features

- › Two stainless safety screws per actuator

---

▼ Hinged actuator right for safety switches NZ.VZ, NZ.VZ.VS and TZ



**024299** RADIUSBETAETIGER-Z-R

▼ Features

- › Two stainless safety screws per actuator



**100406** RADIUSBETAETIGER-Z-R-C2194

▼ Features

- › Two stainless safety screws per actuator
- › Smaller door radii



**074412** RADIUSBETAETIGER-Z-R/V25

▼ Features

- › Two stainless safety screws per actuator
- › Packaging unit 25 pieces

---

## Mounting accessories

▼ Mounting plates EMP-B2 for actuators for safety switches CTP, TP...A, STA, STP, TX and TZ



**093458** EMP-B2

---

▼ Mounting plates EMP-B1 for actuators for safety switches CTP, TP...A, STA, STP, TX and TZ



**093457** EMP-B1

---

▼ Mounting plates EMP-SA for safety switches TZ



**094401** EMP-SA

▼ Features

- › For vertical and horizontal mounting of safety switch TZ
- 

▼ Safety screws for actuators, M5 x 10

**073455** M5X10-NIRO/V100 NZ/TZ

▼ Features

- › Safety screws M5 x 10
  - › Packaging unit 100 pieces
- 

▼ Safety screws for actuators, M5 x 16

**073456** M5X16/V100

▼ Features

- › Safety screws M5 x 16
  - › Packaging unit 100 pieces
- 

▼ Safety screws M5 x 25

**073457** M5X25/V100

▼ Features

- › Safety screws M5 x 25
  - › Packaging unit 100 pieces
- 

## Connection material

---

▼ Cable glands M20x1.5



**077684** EKVM20/09

---

## Instructions













▼ Betriebsanleitung Sicherheitsschalter TZ...

**Doc. no.**   **Version**   **Language**   **Download**

Betriebsanleitung Sicherheitsschalter TZ... Operating Instructions TZ... Safety Switch Manual de instrucciones del interruptor de seguridad TZ... Mode d'emploi Interrupteur de sécurité TZ... Istruzioni di impiego dei finecorsa di sicurezza TZ...	2088062	09-05/18	    	 6.9 MB
Instrukcja obsługi wyłącznika bezpieczeństwa TZ...	2088062	09-05/18		 1.8 MB
Manual de instruções da chave de segurança TZ...	2088062	09-05/18		 1.5 MB
Руководство по эксплуатации предохранительных выключателей TZ...	2088062	09-05/18		 1.9 MB
Návod na obsluhu – bezpečnostný spínač TZ...	2088062	09-05/18		 1.8 MB
使用说明书安全开关 TZ...	2088062	09-05/18		 1.6 MB

## Catalogs

- ✓ Sicherheitsschalter mit Metallgehäuse Safety Switches with Metal Housing Bezpečnostní spínače s kovovým pouzdem Interrupteurs de sécurité avec boîtier métallique 金属壳体的安全开关 Interruptores de seguridad con carcasa metálica

	Doc. no.	Version	Language	Download
Sicherheitsschalter mit Metallgehäuse	100319	11-03/18		 7.9 MB
Interrupteurs de sécurité avec boîtier métallique	100676	11-03/18		 7.9 MB
Interruptores de seguridad con carcasa metálica	104856	11-03/18		 14.0 MB
Safety Switches with Metal Housing	100369	11-03/18		 7.9 MB
Bezpečnostní spínače s kovovým pouzdem	121650	11-03/18		 7.9 MB
金属壳体的安全开关	102453	11-03/18		 8.2 MB

## Declaration of conformity

- ✓ EU prohlášení o shodě

	Doc. no.	Version	Language	Download
EU-Konformitätserklärung Declaración UE de conformidad Déclaration UE de conformité Dichiarazione di conformità EU declaration of conformity	2077153	25-02/17	    	 0.3 MB
EU prohlášení o shodě EU-overensstemmelseserklæring Δήλωση συμμόρφωσης της ΕΕ EU-vaatimustenmukaisuusvakuutus EU-típusbizonyítvány EU-conformiteitsverklaring Deklaracja zgodności UE Declaração de Conformidade UE Declarația de conformitate UE EÚ vyhlásenie o zhode	2077153	25-02/17	         	 0.5 MB

## CAD data

CAD data for this item on TraceParts