

## ITEM 094423 TZ1RE024SEM4AS1-C1815

Description	Technical data	Accessories	Downloads
-------------	----------------	-------------	-----------

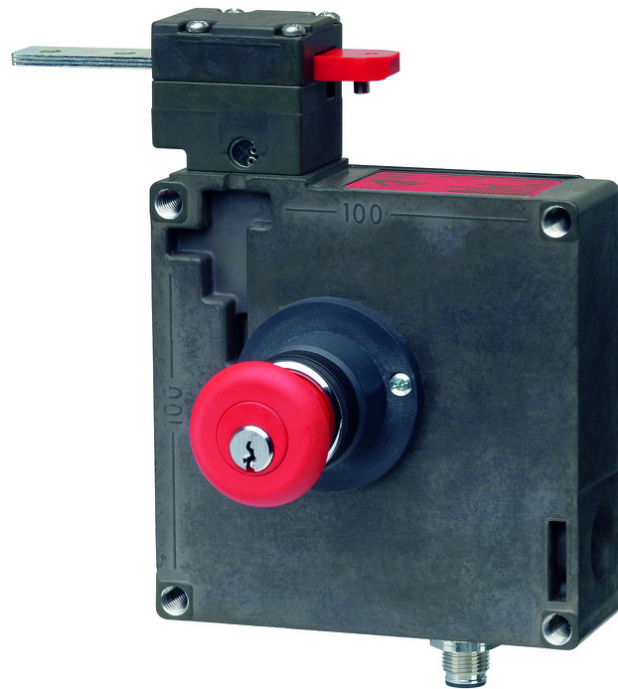

### Features

- › Auxiliary release on the front
- › Escape release on the rear with key button
- › Actuating head fitted right

### Guard locking type

**TZ1** Closed-circuit current principle, guard locking by spring force. Release by control of AS-i output 0.

### Control of the guard locking solenoid

The guard locking solenoid is controlled by the control system via AS-Interface bus bit D0. In addition the 24V connection can be switched safely.

### AS-Interface inputs

**D0, D1** Door monitoring contact SK  
**D2, D3** Solenoid monitoring contact ÜK  
Evaluation is performed via a safety monitor.

## AS-Interface outputs

- D0** Guard locking solenoid
- D1** Red LED
- D2** Green LED

---

## LED function display

- › The Power LED indicates the operating voltage on the bus.
- › The Fault LED indicates if a fault has been detected on the AS-Interface bus.
- › The green and the red LEDs can be controlled as required by the control system via the bus using bits D1 and D2.

---

## Auxiliary release

Is used for releasing the guard locking with the aid of a tool. A seal and auxiliary tool are fitted to protect against tampering.

---

## Escape release

This is used for manual release of guard locking from within the danger area without tools. The disable can only be removed and the switch returned to its operating state using a key included.

## Approvals



## Mechanical values and environment

Housing material	Anodized die-cast alloy
Weight	Net 1,2 kg
Ambient temperature	-25 ... 55 °C
Degree of protection	IP67
Mechanical life	1 x 10 <sup>6</sup>
Contact material	Silver alloy, gold flashed
Switching principle	Slow-action switching contact
Installation position	Any
Number of door position positively driven contacts	
According to As-i Safety at Work	1 D0,D1 [1]
Number of guard lock monitoring positively driven contacts	
According to As-i Safety at Work	1 D2,D3 [2]
Connection	
	1 x Plug connector M12 [3]

Approach speed	max. 20 m/min
Actuation frequency	1200 1/h
Guard locking principle	Closed-circuit current principle
Retention force	10 N
Extraction force	30 N
Actuating force	35 N
Insertion depth	52 mm

### Electrical connection ratings

ASi voltage	22,5 ... 30 V 31,6 V
ASi operating current	max.45 mA
ASi auxiliary voltage	
IEC 60742, PELV	24 V -15% ... +10%
ASi auxiliary current	350 mA
Solenoid duty cycle	100 %
ASi slave type	
According to ASI specification 2.1	EA code: 7
According to ASI specification 2.1	ID code: B
ASi data in	
According to ASI safety at work	D0,D1,D2,D3 [4]
ASi data out	
Guard locking solenoid	D0 [5]
LED red	D1 [6]
LED green	D2 [7]
ASi LED	
LED green	Power [8]
LED red	Fault [9]

### Miscellaneous

C number	C1815 with escape release [10]
----------	--------------------------------

### Reliability values acc. to EN ISO 13849-1

B10 <sub>D</sub>	$3 \times 10^6$
------------------	-----------------

### in combination with Actuator BETAETIGER-Z-G

### Mechanical values and environment

Overtravel	4 mm
------------	------

### in combination with Actuator BETAETIGER-Z-GN

## Mechanical values and environment

Overtravel

16 mm

[1] 1 = Door closed

[2] 1 = Locked

[3] 4-pin

[4] See positively driven NC contact

[5] 1 = Solenoid energized

[6, 7] 1 = LED on

[8] ASI voltage is present

[9] Offline phase or address 0

[10] (Mushroom-head key button)

## Dimension drawing

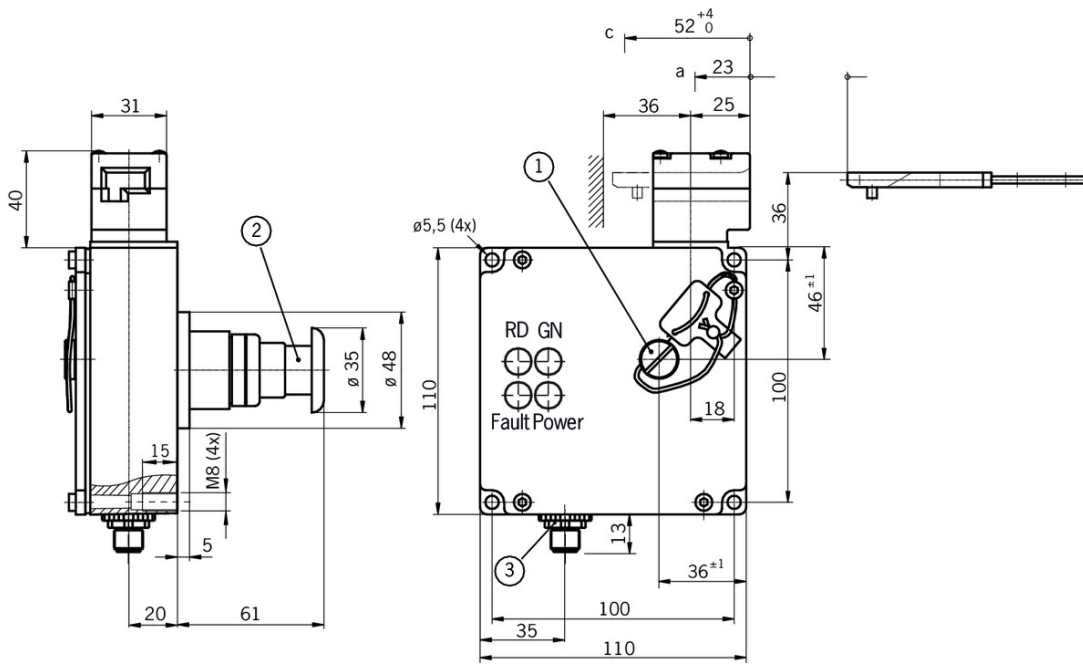

TZ.L...

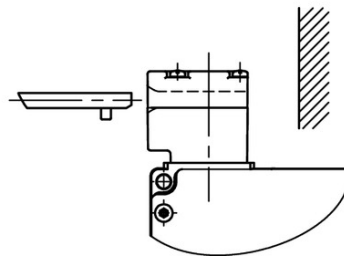

## Legende

- 1 Auxiliary release
- 2 Escape release (red key button)
- 3 Plug connector not aligned

## Connector assignment

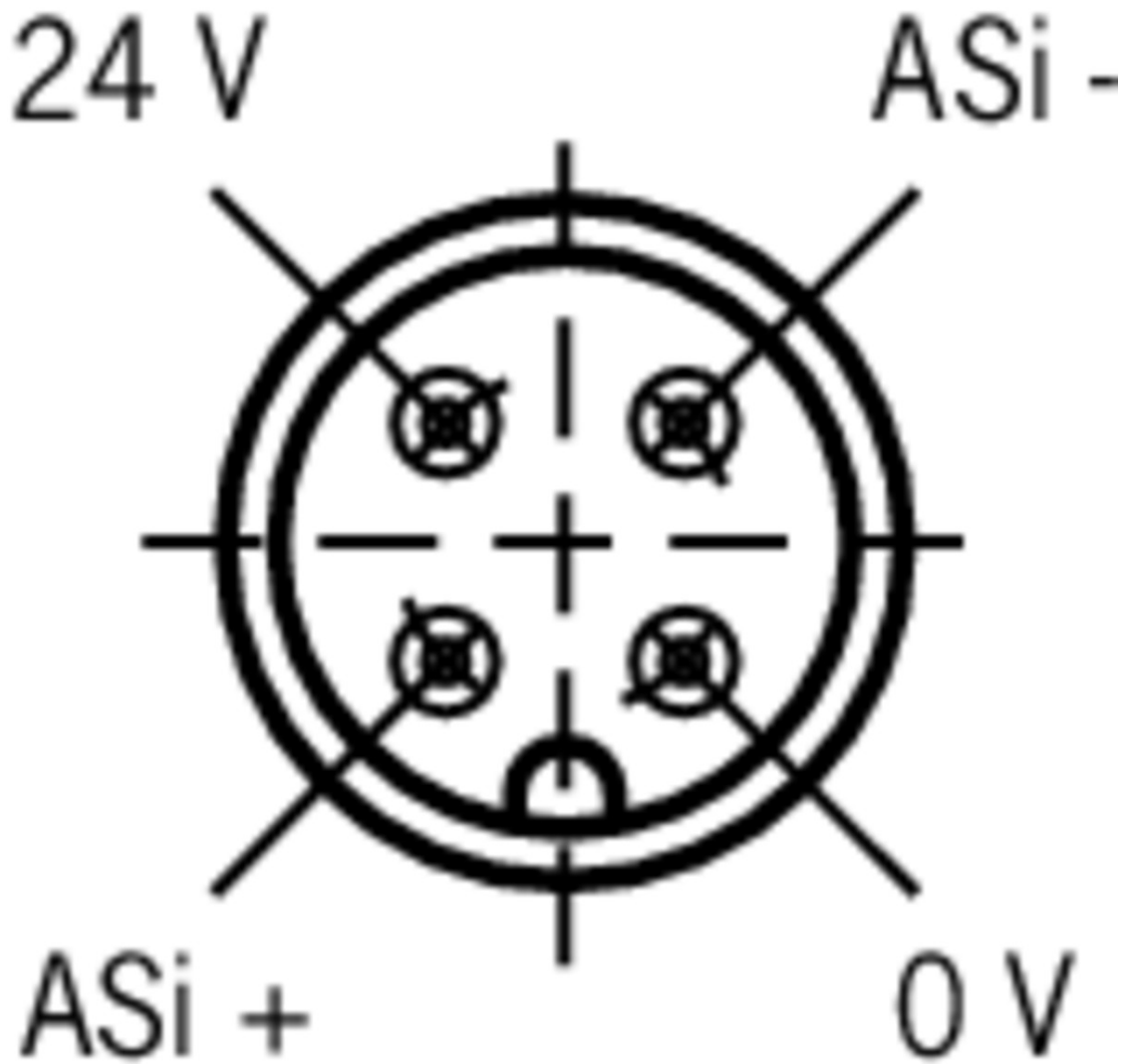

## Legende

View of connection side

## Actuator

Actuators for safety switches NZ.VZ, NZ.VZ.VS and TZ



**016849** BETAETIGER-Z-G

Features

- › Two stainless safety screws per actuator



**074411** BETAETIGER-Z-G/V25

Features

- › Two stainless safety screws per actuator
- › Packaging unit 25 pieces



**097436** BETAETIGER-Z-GME

✓ Features

- › Made of solid stainless steel
- › Two stainless safety screws per actuator



**072251** BETAETIGER-Z-GN

✓ Features

- › Two stainless safety screws per actuator

✓ Hinged actuator right for safety switches NZ.VZ, NZ.VZ.VS and TZ



**024299** RADIUSBETAETIGER-Z-R

✓ Features

- › Two stainless safety screws per actuator



**074412** RADIUSBETAETIGER-Z-R/V25

✓ Features

- › Two stainless safety screws per actuator
- › Packaging unit 25 pieces



**100406** RADIUSBETAETIGER-Z-R-C2194

✓ Features

- › Two stainless safety screws per actuator
- › Smaller door radii

✓ Hinged actuator left for safety switches NZ.VZ, NZ.VZ.VS and TZ



**024298** RADIUSBETAETIGER-Z-L

✓ Features

- › Two stainless safety screws per actuator



**074413** RADIUSBETAETIGER-Z-L/V25

✓ Features

- › Two stainless safety screws per actuator
- › Packaging unit 25 pieces



**100407** RADIUSBETAETIGER-Z-L-C2194

✓ Features

- › Two stainless safety screws per actuator
- › Smaller door radii

✓ Hinged actuator bottom for safety switches NZ.VZ, NZ.VZ.VS and TZ



**048850** RADIUSBETAETIGER-Z-U

✓ Features

- › Two stainless safety screws per actuator

**074414** RADIUSBETAETIGER-Z-U/V25



- ✔ Features
    - › Two stainless safety screws per actuator
    - › Packaging unit 25 pieces
- 

- ✔ Hinged actuator top for safety switches NZ.VZ, NZ.VZ.VS and TZ



- ✔ **057950** RADIUSBETAETIGER-Z-O
    - ✔ Features
      - › Two stainless safety screws per actuator
- 



- ✔ **074415** RADIUSBETAETIGER-Z-O/V25
    - ✔ Features
      - › Two stainless safety screws per actuator
      - › Packaging unit 25 pieces
- 

## Bolt

---

- ✔ Bolts NZ/TZ-S1/AF and NZ/TZ-S1/CF with escape release for safety switches NZ.VZ, NZ.VZ.VS and TZ with escape release



- ✔ **079786** RIEGEL NZ/TZ-S1/AF
    - ✔ Features
      - › Aluminum bolt
      - › For doors hinged on the right
      - › Escape release
      - › Spring catch in open position
      - › Can be locked in open position with padlocks
      - › Actuator included
- 

- ✔ Bolt NZ/TZ-ACF with escape release for safety switches NZ.VZ and TZ with escape release



- ✔ **083900** RIEGEL NZ/TZ-ACF
    - ✔ Features
      - › Steel bolt
      - › For doors hinged on the right or left
      - › Lever for escape release from the danger area
      - › Detent knob in open position
      - › Can be locked in open position with padlocks
      - › Bolt for two safety switches
      - › Actuator included
- 

- ✔ Bolt TZ-AF with escape release for safety switches TZ with escape release



- ✔ **076200** RIEGEL TZ-AF
  - ✔ Features
    - › Steel bolt
    - › For doors hinged on the right
    - › Escape release
    - › Lever for escape release from the danger area
    - › Detent knob in open position
    - › Can be locked in open position with padlocks

- › Actuator and switch bracket included
- 

- ▼ Bolt BTC-TZ00... with escape release for safety switch TZ



**106279** BTC-TZ00-A-TH-01-F

▼ Features

- › Aluminum bolt
  - › For doors hinged on the right
  - › Lever for escape release from the danger area
  - › Pushbutton in open position
  - › Can be locked in open position with padlocks
  - › Actuator included
- 

## Mounting accessories

---

- ▼ Mounting plates EMP-SA for safety switches TZ



**094401** EMP-SA

▼ Features

- › For vertical and horizontal mounting of safety switch TZ
- 

- ▼ Mounting plates EMP-B1 for actuators for safety switches CTP, TP...A, STA, STP, TX and TZ



**093457** EMP-B1

- ▼ Mounting plates EMP-B2 for actuators for safety switches CTP, TP...A, STA, STP, TX and TZ



**093458** EMP-B2

- ▼ Safety screws for actuators, M5 x 10

**073455** M5X10-NIRO/V100 NZ/TZ

▼ Features

- › Safety screws M5 x 10
  - › Packaging unit 100 pieces
- 

- ▼ Safety screws for actuators, M5 x 16

**073456** M5X16/V100

▼ Features

- › Safety screws M5 x 16
  - › Packaging unit 100 pieces
- 

- ▼ Safety screws M5 x 25

**073457** M5X25/V100

▼ Features

- › Safety screws M5 x 25
  - › Packaging unit 100 pieces
- 

## Function expansion

---

- ▼ Lockout mechanism NZ.VZ/TZ, 3 holes



**046730** SPERREINSATZ-Z-046730

- ▼ Features

- › Prevents unintentional closing of the door
  - › Can be secured with padlocks
- 



**091305** SPERREINSATZ MIT KETTE

- ▼ Features

- › Prevents unintentional closing of the door
  - › Can be secured with padlocks
- 

- ▼ Lockout mechanism NZ.VZ/TZ, 5 holes

**086538** SPERREINSATZ-Z-086538

- ▼ Features

- › Prevents unintentional closing of the door
  - › Can be secured with padlocks
- 

- ▼ Protective plate NZ.VZ/TZ

**059136** SCHUTZBLECH NZ/TZ

---

## Spare parts

---

- ▼ Lead seal kit

**048257** PLOMBENSATZ TZ

---

## Connection material

---

- ▼ Bus coupling module with plug connector M12, 5-pin



**105756** BCM-A-P2-SEM4-1

- ▼ Features

- › Conversion from M12 to ribbon cable
  - › Very compact design
  - › Easy handling
-







## Instructions

### ▼ Betriebsanleitung Sicherheitsschalter TZ...AS1

	Doc. no.	Version	Language	Download
Betriebsanleitung Sicherheitsschalter TZ...AS1	086963	07-08/15		 4.0 MB
Mode d'emploi pour les interrupteurs de sécurité TZ...AS1				
Istruzioni di impiego dei finecorsa di sicurezza TZ...AS1				
Operating Instructions Safety Switches TZ...AS1				
Инструкция по эксплуатации предохранительных выключателей TZ...AS1	086963	07-08/15		 0.4 MB

## Catalogs

### ▼ Sicherheitsschalter mit AS-Interface Safety Switches with AS-Interface Interrupteurs de sécurité avec AS-Interface

	Doc. no.	Version	Language	Download
Sicherheitsschalter mit AS-Interface	092164	11-04/17		 2.3 MB
Interrupteurs de sécurité avec AS-Interface	112564	11-04/17		 2.3 MB
Safety Switches with AS-Interface	092332	11-04/17		 2.3 MB

## Declaration of conformity

### ▼ EU prohlášení o shodě

	Doc. no.	Version	Language	Download
EU-Konformitätserklärung	2077153	25-02/17		 0.3 MB
Declaración UE de conformidad				
Déclaration UE de conformité				
Dichiarazione di conformità				
EU declaration of conformity				
EU prohlášení o shodě	2077153	25-02/17		 0.5 MB
EU-overensstemmelseserklæring				
Δήλωση συμμόρφωσης της ΕΕ				
EU-vaatimustenmukaisuusvakuutus				
EU-típusbizonyítvány				
EU-conformiteitsverklaring				
Deklaracja zgodności UE				
Declaração de Conformidade UE				
Declarația de conformitate UE				
EÚ vyhlásenie o zhode				

## CAD data

CAD data for this item on TraceParts