

ITEM 090343 NZ1VZ-511E3VSE04-M

Description	Technical data	Accessories	Downloads
-------------	----------------	-------------	-----------



Features

- › Housing according to EN 50041
- › Cable entry M20 x 1.5

Approach direction

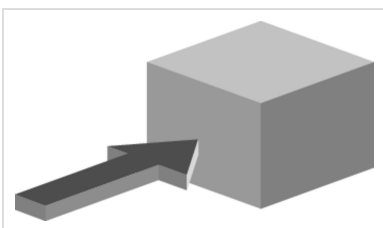

- › Figure
Horizontal
Can be adjusted in 90° steps

Guard locking type

VSE Open-circuit current principle, guard locking by applying voltage to the solenoid. Release by spring force.

Switching element

511 Snap-action switching contact 1 NC \ominus + 1 NO

Approvals



Mechanical values and environment

Housing material	Anodized die-cast alloy
Weight	Net 0,7 kg
Ambient temperature	-25 ... 80 °C
Degree of protection	IP65
Mechanical life	2 x 10 ⁶
Contact material	Silver alloy, gold flashed
Switching principle	Snap-action switching contact
Solenoid alignment	3
Installation position	Any
Number of door position positively driven contacts	1
Number of door position NO contacts	1
Connection	1 x M20 x 1.5
Approach speed	max.20 m/min
Actuation frequency	1200 1/h
Guard locking principle	Open-circuit current principle
Locking force F _{max}	2000 N
Locking force F _{Zh}	1500 N
Retention force	35 N
Extraction force	40 N
Actuating force	45 N
Insertion depth	52 mm

Electrical connection ratings

Rated thermal current I _{th}	6 A [1]
Utilization category according to EN 60947-5-1	AC-15 6A 230V [2] DC-13 6A 24V [3]
Solenoid operating voltage	DC 24 V -15 ... 10

Short circuit protection according to IEC 60269-1	(Fuse)	6A gG [4]
Rated insulation voltage U _i	AC/DC	250 V
Rated impulse withstand voltage U _{imp}		2,5 kV
Switching voltage	Min. at 10mA	12 V
Switching current	Min. at 24V	10 mA
Connection cross-section		0,34 ... 0,75 mm ²

Reliability values acc. to EN ISO 13849-1

	Control of the guard locking
Category	Depending on external control of guard locking
Performance Level	Depending on external control of guard locking
PFH _D	Depending on external control of guard locking
	Monitoring of the position of the safety guard
B10 _D	4,5 x 10 ⁶

in combination with Actuator BETAETIGER-Z-G

Mechanical values and environment

Overtravel	4 mm
------------	------

in combination with Actuator BETAETIGER-Z-GN

Mechanical values and environment

Overtravel	16 mm
------------	-------

[1, 2, 3] > 70° C => 2 A

[4] > 70° C => 2 A gG

Dimension drawing

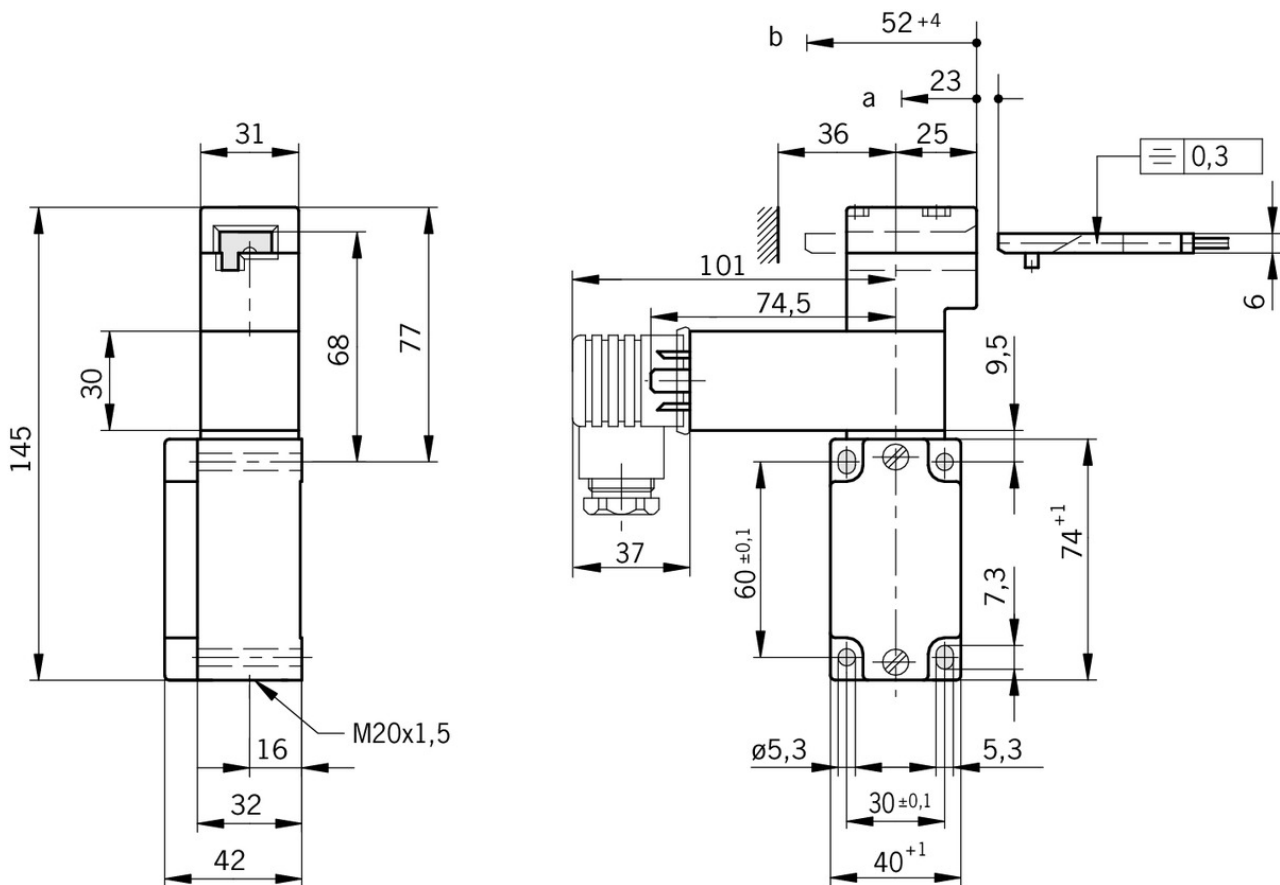

Legende

- a* Travel without operation: actuator is in the guide slot, but function is not triggered.
- b* Switching operation completed: actuator must be inserted to this point to ensure reliable switching. The actuator must be withdrawn at least to point a for switching off.

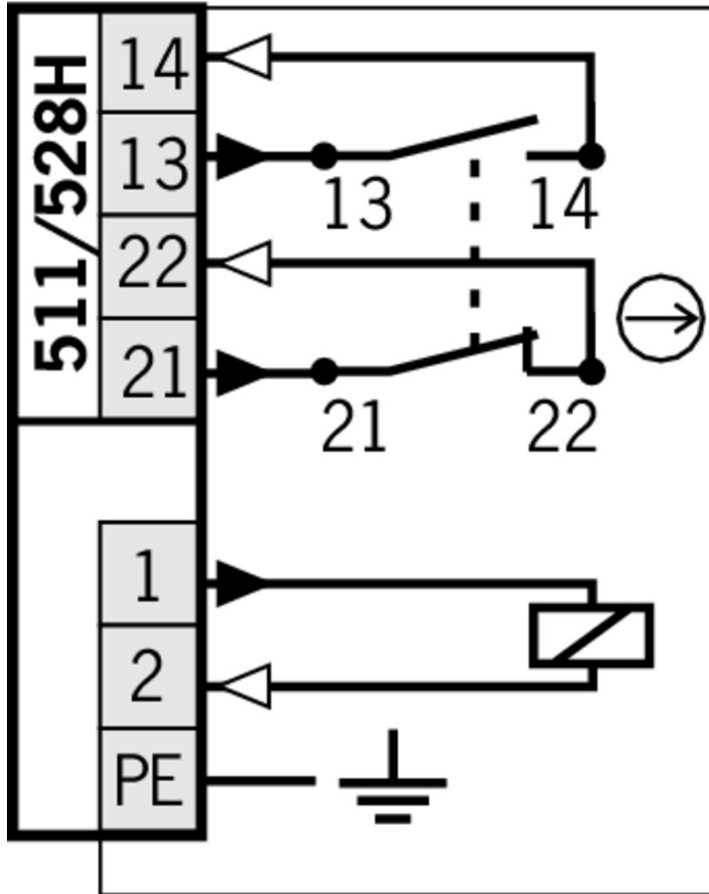

Switching functions

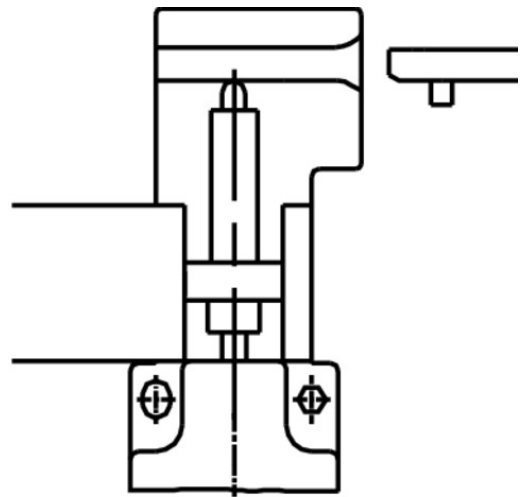
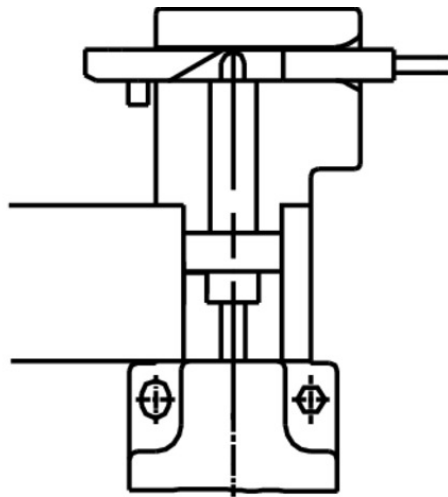

511
528

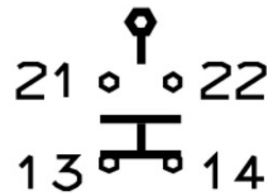
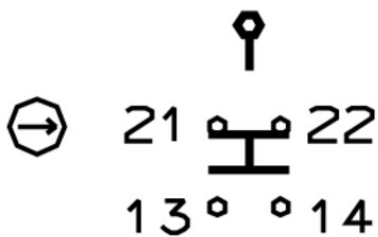

Function expansion

Lockout mechanism NZ.VZ/TZ, 3 holes



046730 SPERREINSATZ-Z-046730

Features

- › Prevents unintentional closing of the door
- › Can be secured with padlocks



091305 SPERREINSATZ MIT KETTE

Features

- › Prevents unintentional closing of the door
- › Can be secured with padlocks

Lockout mechanism NZ.VZ/TZ, 5 holes

086538 SPERREINSATZ-Z-086538

Features

- › Prevents unintentional closing of the door
- › Can be secured with padlocks

Protective plate NZ.VZ/TZ

059136 SCHUTZBLECH NZ/TZ

▼ LED function display NZ



029220 NGL060RT



029221 NGL060GR

Mounting accessories

▼ Mounting plates EMP-B1 for actuators for safety switches CTP, TP...A, STA, STP, TX and TZ



093457 EMP-B1

▼ Mounting plates EMP-SC for safety switches NM, NP...AS and NZ



085753 EMP-SC

▼ Features

- › For vertical and horizontal mounting of safety switches NM, NP...AS and NZ
-

▼ Mounting plates EMP-B2 for actuators for safety switches CTP, TP...A, STA, STP, TX and TZ



093458 EMP-B2

Spare parts

▼ Replacement head NZ.VZ

076250 BETAETIGUNGSKOPF NZVZ

Bolt

▼ Bolt NZ-C... for safety switches NZ.VZ and NZ.VZ.VS



083892 RIEGEL NZ-CB

▼ Features

- › Steel bolt
 - › For doors hinged on the left
 - › Ball detent mechanism in closed position
 - › Can be locked in open position with padlocks
 - › Actuator and switch bracket included
-

078456 RIEGEL NZ-CR2



▼ Features

- › Steel bolt
 - › For doors hinged on the left
 - › Detent knob in open position
 - › Detent knob mechanism in closed position
 - › Can be locked in open position with padlocks
 - › Actuator and switch bracket included
-

▼ Bolt NZ-A... for safety switches NZ.VZ and NZ.VZ.VS



078455 RIEGEL NZ-AR2

▼ Features

- › Steel bolt
 - › For doors hinged on the right
 - › Detent knob in open position
 - › Detent knob in closed position
 - › Can be locked in open position with padlocks
 - › Actuator and switch bracket included
-



083890 RIEGEL NZ-AB

▼ Features

- › Steel bolt
 - › For doors hinged on the right
 - › Ball detent mechanism in closed position
 - › Can be locked in open position with padlocks
 - › Actuator and switch bracket included
-

▼ Bolts NZ/TZ-S1 and NZ/TZ-S2 for safety switches NZ.VZ, NZ.VZ.VS and TZ



028357 RIEGEL NZ/TZ-S1

▼ Features

- › Aluminum bolt
 - › For doors hinged on the left or right. Cone grip bottom.
 - › Spring catch in open position
 - › Can be locked in open position with padlocks
 - › Actuator included
-



028359 RIEGEL NZ/TZ-S2

▼ Features

- › Aluminum bolt
 - › For doors hinged on the left or right. Cone grip top.
 - › Spring catch in open position
 - › Can be locked in open position with padlocks
 - › Actuator included
-

▼ Bolts NZ/TZ-S1/AF and NZ/TZ-S1/CF with escape release for safety switches NZ.VZ, NZ.VZ.VS and TZ with escape release



079786 RIEGEL NZ/TZ-S1/AF

▼ Features

- › Aluminum bolt
- › For doors hinged on the right
- › Escape release

- › Spring catch in open position
- › Can be locked in open position with padlocks
- › Actuator included



079785 RIEGEL NZ/TZ-S1/CF

✓ Features

- › Aluminum bolt
- › For doors hinged on the left
- › Escape release
- › Spring catch in open position
- › Can be locked in open position with padlocks
- › Actuator included

✓ Bolt NZ-A for safety switches NZ.VZ and NZ.VZ.VS



057734 RIEGEL NZ-A

✓ Features

- › Steel bolt
- › For doors hinged on the right
- › Can be locked in open position with padlocks
- › Actuator and switch bracket included
- › Bolt is not allowed to be used in conjunction with an escape release.

✓ Bolt NZ-C for safety switches NZ.VZ and NZ.VZ.VS



057735 RIEGEL NZ-C

✓ Features

- › Steel bolt
- › For doors hinged on the left
- › Can be locked in open position with padlocks
- › Actuator and switch bracket included

Actuator

✓ Hinged actuator top for safety switches NZ.VZ, NZ.VZ.VS and TZ



074415 RADIUSBETAETIGER-Z-O/V25

✓ Features

- › Two stainless safety screws per actuator
- › Packaging unit 25 pieces



057950 RADIUSBETAETIGER-Z-O

✓ Features

- › Two stainless safety screws per actuator

✓ Actuators for safety switches NZ.VZ, NZ.VZ.VS and TZ



016849 BETAETIGER-Z-G

✓ Features

- › Two stainless safety screws per actuator



074411 BETAETIGER-Z-G/V25

✓ Features

- › Two stainless safety screws per actuator
- › Packaging unit 25 pieces



097436 BETAETIGER-Z-GME

✓ Features

- › Made of solid stainless steel
- › Two stainless safety screws per actuator



072251 BETAETIGER-Z-GN

✓ Features

- › Two stainless safety screws per actuator

✓ Hinged actuator bottom for safety switches NZ.VZ, NZ.VZ.VS and TZ



074414 RADIUSBETAETIGER-Z-U/V25

✓ Features

- › Two stainless safety screws per actuator
- › Packaging unit 25 pieces



048850 RADIUSBETAETIGER-Z-U

✓ Features

- › Two stainless safety screws per actuator

✓ Hinged actuator right for safety switches NZ.VZ, NZ.VZ.VS and TZ



024299 RADIUSBETAETIGER-Z-R

✓ Features

- › Two stainless safety screws per actuator



074412 RADIUSBETAETIGER-Z-R/V25

✓ Features

- › Two stainless safety screws per actuator
- › Packaging unit 25 pieces



100406 RADIUSBETAETIGER-Z-R-C2194

✓ Features

- › Two stainless safety screws per actuator
- › Smaller door radii

✓ Hinged actuator left for safety switches NZ.VZ, NZ.VZ.VS and TZ



024298 RADIUSBETAETIGER-Z-L

✓ Features

- › Two stainless safety screws per actuator



074413 RADIUSBETAETIGER-Z-L/V25

Features

- › Two stainless safety screws per actuator
- › Packaging unit 25 pieces



100407 RADIUSBETAETIGER-Z-L-C2194

Features

- › Two stainless safety screws per actuator
- › Smaller door radii

Connection material

▼ Cable glands M20x1.5



077683 EKVM20/06



077684 EKVM20/09

▼ Solenoid plug for safety switch NZ.VZ.VS

028345 STECKVERBINDER FUER MAGNETVERRIEG.

Features

- › Without rectifier for the connection of DC.

Instructions













▼ Istruzioni di impiego Finecorsa di sicurezza NZ.VZ-...VS

	Doc. no.	Version	Language	Download
Betriebsanleitung Sicherheitsschalter NZ.VZ-...VS	094066	07-08/16		2.2 MB
Manual de instrucciones Interruptor de seguridad NZ.VZ-...VS				
Mode d'emploi Interrupteur de sécurité NZ.VZ-...VS				
Operating Instructions Safety Switch NZ.VZ-...VS				
Istruzioni di impiego Finecorsa di sicurezza NZ.VZ-...VS	094066	07-08/16		0.6 MB
Návod na prevádzku Bezpečnostný spínač NZ.VZ-...VS	094066	07-08/16		0.6 MB

Catalogs

▼ Sicherheitsschalter mit Metallgehäuse Safety Switches with Metal Housing Bezpečnostní spínače s kovovým pouzdrém Interrupteurs de sécurité avec boîtier métallique 金属壳体的安全开关

Interruptores de seguridad con carcasa metálica

	Doc. no.	Version	Language	Download
Sicherheitsschalter mit Metallgehäuse	100319	11-03/18		 7.9 MB
Interrupteurs de sécurité avec boîtier métallique	100676	11-03/18		 7.9 MB
Interruptores de seguridad con carcasa metálica	104856	11-03/18		 14.0 MB
Safety Switches with Metal Housing	100369	11-03/18		 7.9 MB
Bezpečnostní spínače s kovovým pouzdem	121650	11-03/18		 7.9 MB
金属壳体 的安全开关	102453	11-03/18		 8.2 MB

Declaration of conformity

EU prohlášení o shodě

	Doc. no.	Version	Language	Download
EU-Konformitätserklärung	2077153	25-02/17		 0.3 MB
Declaración UE de conformidad				
Déclaration UE de conformité				
Dichiarazione di conformità				
EU declaration of conformity				
EU prohlášení o shodě	2077153	25-02/17		 0.5 MB
EU-overensstemmelseserklæring				
Δήλωση συμμόρφωσης της ΕΕ				
EU-vaatimustenmukaisuusvakuutus				
EU-típusbizonyítvány				
EU-conformiteitsverklaring				
Deklaracja zgodności UE				
Declaração de Conformidade UE				
Declarația de conformitate UE				
EÚ vyhlásenie o zhode				

CAD data

CAD data for this item on TraceParts