

ITEM 105617 STA-TW-3A-2131AC024M

Description	Technical data	Accessories	Downloads
-------------	----------------	-------------	-----------



Features

- › Actuating heads made of metal
- › Simultaneous monitoring of two safety doors
- › Auxiliary release on the front
- › With door monitoring contact

Approach direction

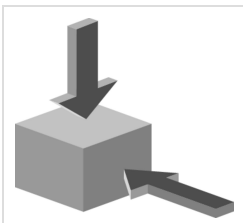

- › Figure
Horizontal and vertical
Can be adjusted in 90° steps

Solenoid operating voltage

- › AC/DC 24 V +10%, -15%

Guard locking type

STA3 Closed-circuit current principle, guard locking by spring force. Release by applying voltage to the guard locking solenoid.

Switching element

2131 Slow-action switching contact 2 NC \ominus + 1 NO + 1 NC (door monitoring contact)

Auxiliary release

Is used for releasing the guard locking with the aid of a tool. To protect against tampering, the auxiliary release is sealed with sealing lacquer.

Approvals



Mechanical values and environment

Housing material	Alloy - die-cast
Weight	Net 0,6 kg
Ambient temperature	-20 ... 55 °C
Degree of protection	IP67
Mechanical life	1 x 10 ⁶
Contact material	Silver alloy, gold flashed
Switching principle	Slow-action switching contact
Installation position	Any
Number of door position NC contacts	1
Number of guard lock monitoring positively driven contacts	2
Number of guard lock monitoring NO contacts	1
Connection	3 x M20 x 1.5
Approach speed	max. 20 m/min
Actuation frequency	1200 1/h
Guard locking principle	Closed-circuit current principle
Locking force F _{max}	2500 N
Locking force F _{Zh}	2000 N
Retention force	20 N
Extraction force	30 N
Actuating force	35 N

Insertion depth	min.24,5 mm
-----------------	-------------

Electrical connection ratings

Rated thermal current I_{th}	4 A
Utilization category according to EN 60947-5-1	AC-15 4A 230V DC-13 4A 24V
Solenoid operating voltage	AC/DC 24 V -15% ... +10%
Short circuit protection according to IEC 60269-1	(Fuse) 4A gG
Rated insulation voltage U_i	250 V
Rated impulse withstand voltage U_{imp}	2,5 kV
Switching voltage	Min. at 10mA 12 V
Switching current	Min. at 24V 1 mA
Power consumption	8 W
Solenoid duty cycle	100 %
Connection cross-section	0,34 ... 1,5 mm ²

Reliability values acc. to EN ISO 13849-1

	Control of the guard locking
Category	Depending on external control of guard locking
Performance Level	Depending on external control of guard locking
PFH _D	Depending on external control of guard locking
	Monitoring of guard locking and the safety guard position
B10 _D	4,5 x 10 ⁶

in combination with Actuator BETAETIGER-S-GT-SN

Mechanical values and environment

Overtravel	5 mm
------------	------

Dimension drawing

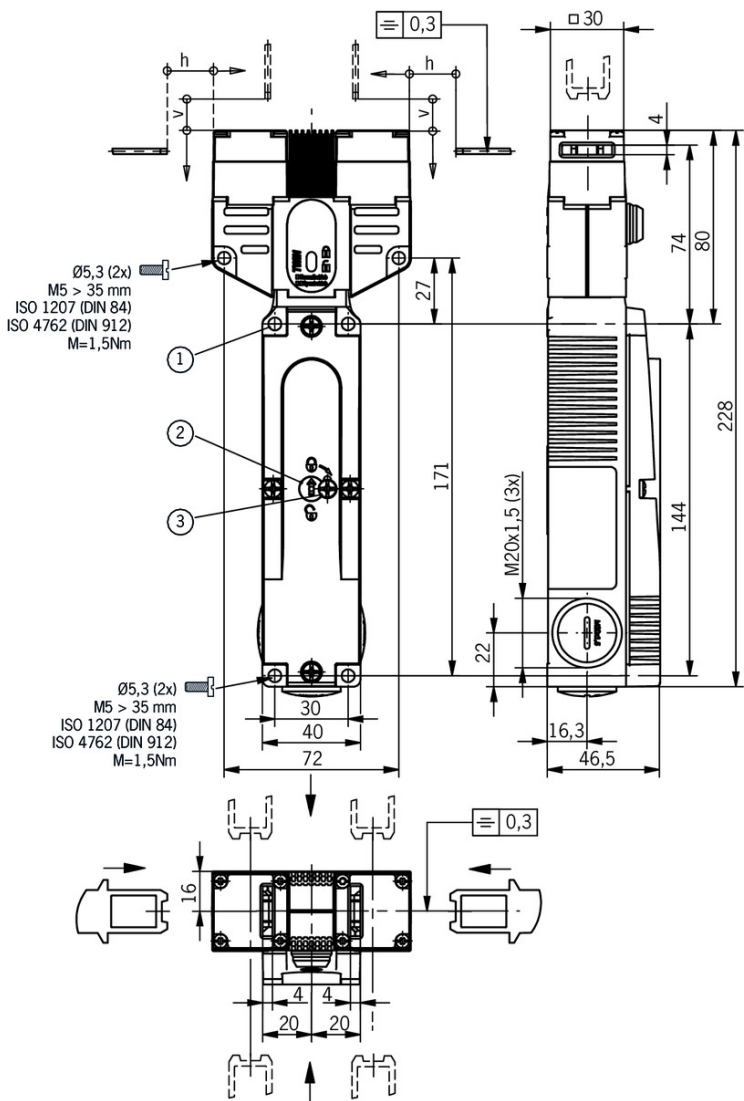

Legende

- 1 Do not screw tight here (2x)
- 2 Auxiliary release
- 3 Locking screw

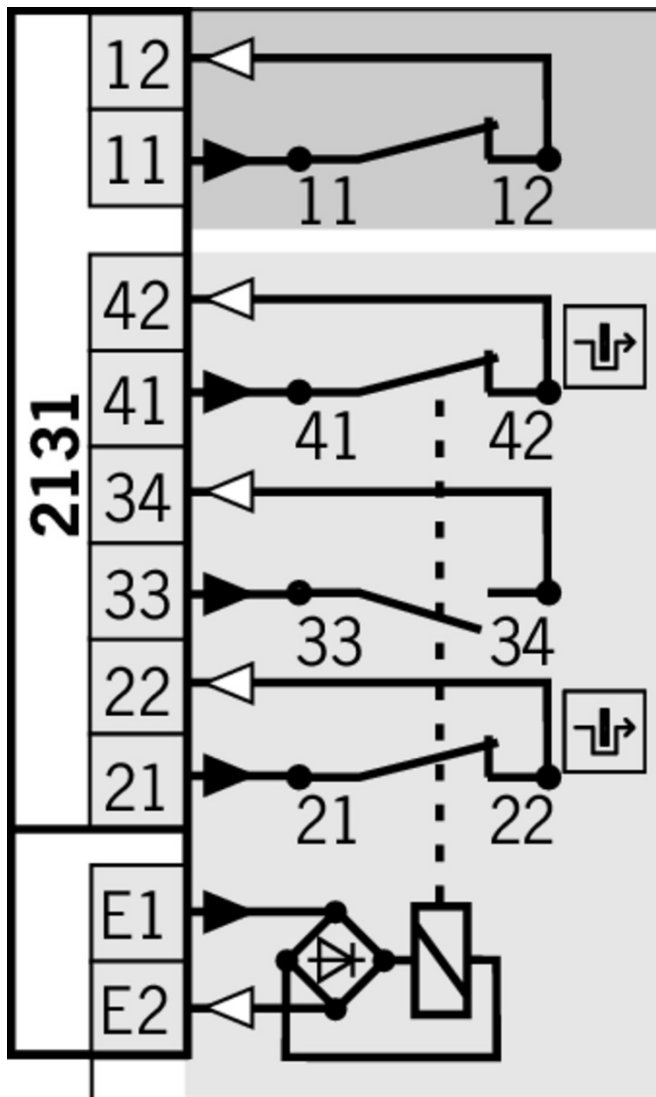

Legende

- Solenoid monitoring
- Door monitoring

Switching functions

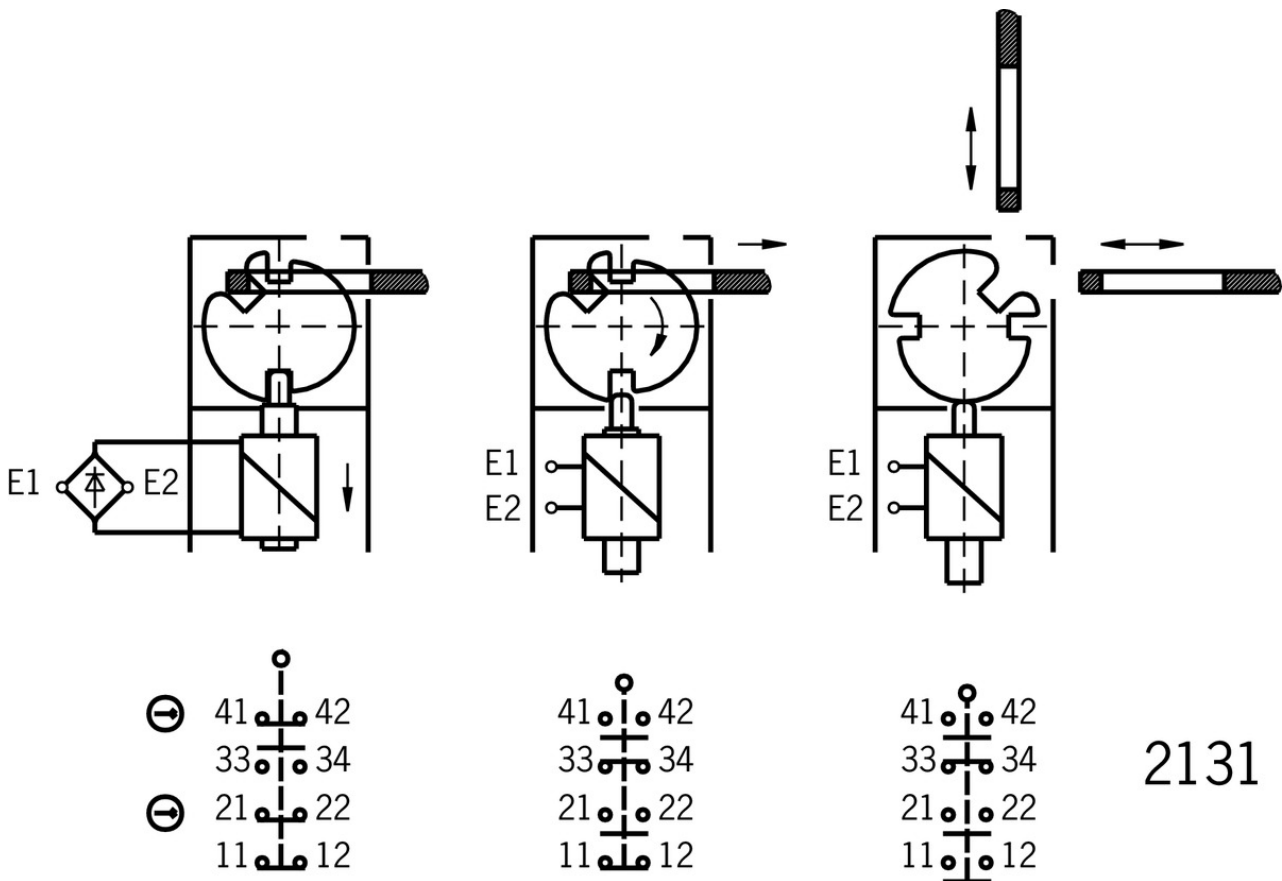

2131

Actuator

- ▼ Hinged actuator S top/bottom for safety switches SGA/SGP/STA/STP/STM



095315 RADIUSBETAETIGER-S-OU-SN

▼ Features

- › Actuators made of stainless steel
- › Two safety screws included
- › For doors hinged at top and bottom

- ▼ Actuator S, bent, for safety switches SGA/SGP/STA/STP/STM



095740 BETAETIGER-S-WQT-SN

▼ Features

- › Two safety screws included

- ▼ Actuator S for safety switches SGA/SGP/STA/STP/STM



095738 BETAETIGER-S-GT-SN

▼ Features

- › Two safety screws included
- › Actuators with rubber bushings

097861 BETAETIGER-S-G-SN-C2115



- ✓ Features
 - › Two safety screws included
 - › Physically compatible with TP actuator P-G
-

- ✓ Hinged actuator S left/right for safety switches SGA/SGP/STA/STP/STM



- 096838** RADIUSBETAETIGER-S-LR-SN
 - ✓ Features
 - › Actuators made of stainless steel
 - › Two safety screws included
 - › For doors hinged on right and left
-

Function expansion

- ✓ Built-in LED



- 087423** EINBAULEUCHTE LED M20X1,5
-



- 095510** EINBAULEUCHTE LED-F M20X1,5
-

- ✓ Emergency unlocking for safety switches STA



- 099876** NOTENTSPERRUNG STA
-

- ✓ Lockout bar STA/STP/SGA/SGP/STM



- 105701** SPERREINSATZ STP/STA
 - ✓ Features
 - › Prevents unintentional closing of the door
 - › Can be secured with padlocks
-

- ✓ LED set

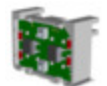

- 098035** STP LED SET
-

- ✓ Handle for escape release for safety switches TP/STP/STA



- 105329** FE-GRIFF
-

- ✓ Wire front release



- 096230** AE-B-A1-02,0-096230
 - ✓ Features

- › Can be used as escape release or emergency unlocking
- › No automatic return
- › Sheath length 2 m (rope length 6 m)



097747 AE-B-A1-02,0-F-097747

✔ Features

- › Can be used as escape release or emergency unlocking
- › automatic return
- › Sheath length 2 m (rope length 6 m)



098313 AE-B-A1-03,0-098313

✔ Features

- › Can be used as escape release or emergency unlocking
- › No automatic return
- › Sheath length 3 m (rope length 6 m)



111233 AE-B-A1-03,0-F-111233

✔ Features

- › Can be used as escape release or emergency unlocking
- › automatic return
- › Sheath length 3 m (rope length 6 m)



098314 AE-B-A1-04,0-098314

✔ Features

- › Can be used as escape release or emergency unlocking
- › No automatic return
- › Sheath length 4 m (rope length 6 m)



125582 AE-B-A1-06,0-125582

✔ Features

- › Can be used as escape release or emergency unlocking
- › No automatic return
- › Rope length 6 m (without sheath)



124770 AE-B-A1-06,0-F-124770

✔ Features

- › Can be used as escape release or emergency unlocking
- › automatic return
- › Rope length 6 m (without sheath)

Connection material

- ✔ Cable glands M20x1.5



086233 EKPM20/06 086233













Instructions

▼ Istruzioni di impiego Finecorsa di sicurezza STA-TW... (Twin)

	Doc. no.	Version	Language	Download
Betriebsanleitung Sicherheitsschalter STA-TW... (Twin)	2105875	05-01/18	 	 5.5 MB
Operating Instructions Safety Switch STA-TW... (Twin)			 	
Manual de instrucciones Interruptores de seguridad STA-TW... (Twin)				
Mode d'emploi Interrupteur de sécurité STA-TW... (Twin)				
Istruzioni di impiego Finecorsa di sicurezza STA-TW... (Twin)	2105875	05-01/18		 1.4 MB

Catalogs

▼ Bezpečnostní spínače s plastovým pouzdrém Sicherheitsschalter mit Kunststoffgehäuse Safety Switches with Plastic Housing Interruptores de seguridad con carcasa plástica Interrupteurs de sécurité avec boîtier plastique 塑料壳体 的安全开关

	Doc. no.	Version	Language	Download
Sicherheitsschalter mit Kunststoffgehäuse	096955	11-03/18		 6.6 MB
Interrupteurs de sécurité avec boîtier plastique	100677	11-03/18		 6.6 MB
Interruptores de seguridad con carcasa plástica	104855	11-03/18		 6.6 MB
Bezpečnostní spínače s plastovým pouzdrém	121649	11-03/18		 6.6 MB
Safety Switches with Plastic Housing	096956	11-03/18		 6.6 MB
塑料壳体 的安全开关	116243	11-03/18		 6.2 MB

Declaration of conformity

▼ EU prohlášení o shodě

	Doc. no.	Version	Language	Download
EU-Konformitätserklärung Declaración UE de conformidad Déclaration UE de conformité Dichiarazione di conformità EU declaration of conformity	2077153	25-02/17	    	 0.3 MB
EU prohlášení o shodě EU-overensstemmelseserklæring Δήλωση συμμόρφωσης της ΕΕ EU-vaatimustenmukaisuusvakuutus EU-típusbizonyítvány EU-conformiteitsverklaring Deklaracja zgodności UE Declaração de Conformidade UE Declarația de conformitate UE EÚ vyhlásenie o zhode	2077153	25-02/17	        	 0.5 MB