

ITEM 095399 STM2A-242B024-M

Description	Technical data	Accessories	Downloads
-------------	----------------	-------------	-----------

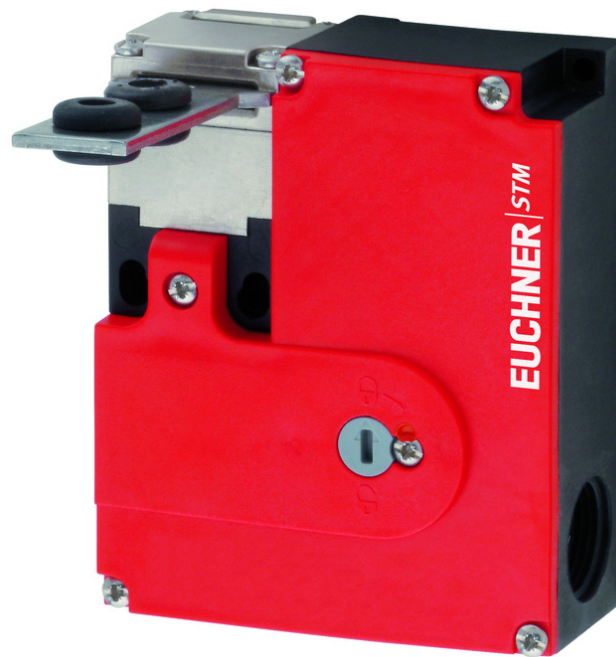

**Features**

- › Actuating head made of metal
- › Auxiliary release on the front

**Approach direction**

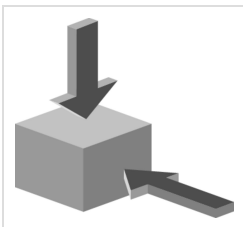

- › Figure  
Horizontal and vertical  
Can be adjusted in 90° steps

**Solenoid operating voltage**

- › AC/DC 24 V +10%, -15%

**Guard locking type**

**STM2** Open-circuit current principle, guard locking by applying voltage to the guard locking solenoid. Release by spring force.

### Switching element

**ÜK** For monitoring the guard locking (built-in solenoid) slow-action switching contact 1 NC $\rightarrow$

**SK** For monitoring the door/actuator position  
Combination available:

**242** Slow-action switching contact 1 NC $\rightarrow$  + 1 NO

### Auxiliary release

Is used for releasing the guard locking with the aid of a tool. To protect against tampering, the auxiliary release is sealed with sealing lacquer.

### Approvals



### Mechanical values and environment

Housing material	Reinforced thermoplastic
Weight	Net 0,4 kg
Ambient temperature	-20 ... 55 °C
Degree of protection	IP67
Mechanical life	$2 \times 10^6$
Contact material	Silver alloy, gold flashed
Switching principle	Slow-action switching contact
Installation position	Any
Number of door position positively driven contacts	1
Number of door position NO contacts	1
Number of guard lock monitoring positively driven contacts	1
Connection	1 x M20 x 1.5
Approach speed	max.20 m/min
Actuation frequency	1200 1/h
Guard locking principle	Open-circuit current principle
Locking force $F_{max}$	2000 N
Locking force $F_{Zh}$	1500 N
Retention force	20 N
Extraction force	30 N
Actuating force	35 N

Insertion depth	min.24,5 mm
-----------------	-------------

### Electrical connection ratings

Rated thermal current $I_{th}$	4 A
Utilization category according to EN 60947-5-1	AC-15 4A 230V DC-13 4A 24V
Solenoid operating voltage	AC/DC 24 V -15% ... +10%
Short circuit protection according to IEC 60269-1	(Fuse) 4A gG
Rated insulation voltage $U_i$	250 V
Rated impulse withstand voltage $U_{imp}$	2,5 kV
Switching voltage	Min. at 10mA 12 V
Switching current	Min. at 24V 1 mA
Power consumption	6 W
Solenoid duty cycle	100 %
Connection cross-section	0,34 ... 1,5 mm <sup>2</sup>

### Reliability values acc. to EN ISO 13849-1

	<b>Monitoring of guard locking and the safety guard position</b>
B10 <sub>D</sub>	$2 \times 10^6$

### in combination with Actuator BETAETIGER-S-GT-SN

### Mechanical values and environment

Overtravel	5 mm
------------	------

**Dimension drawing**

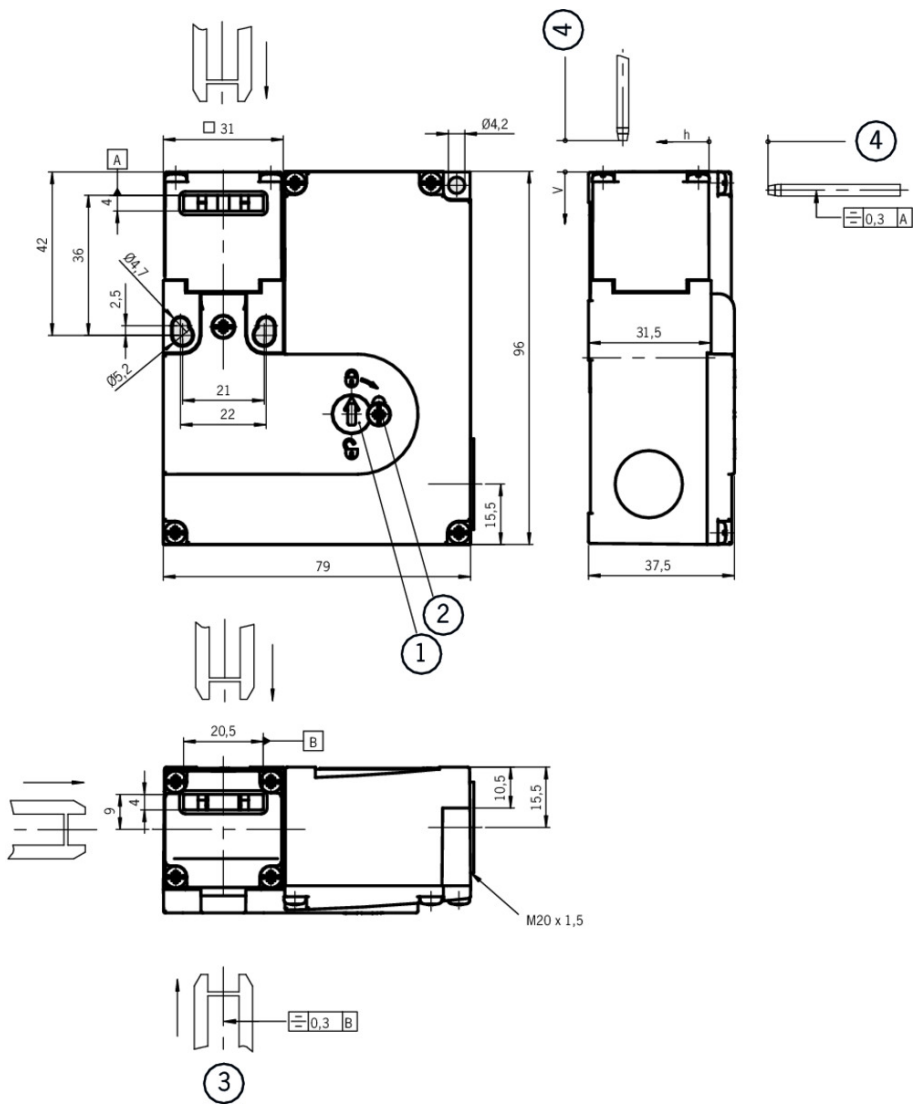

**Legende**

- 1 Auxiliary release
- 2 Locking screw
- 3 Actuator S standard
- 4 Insertion depth

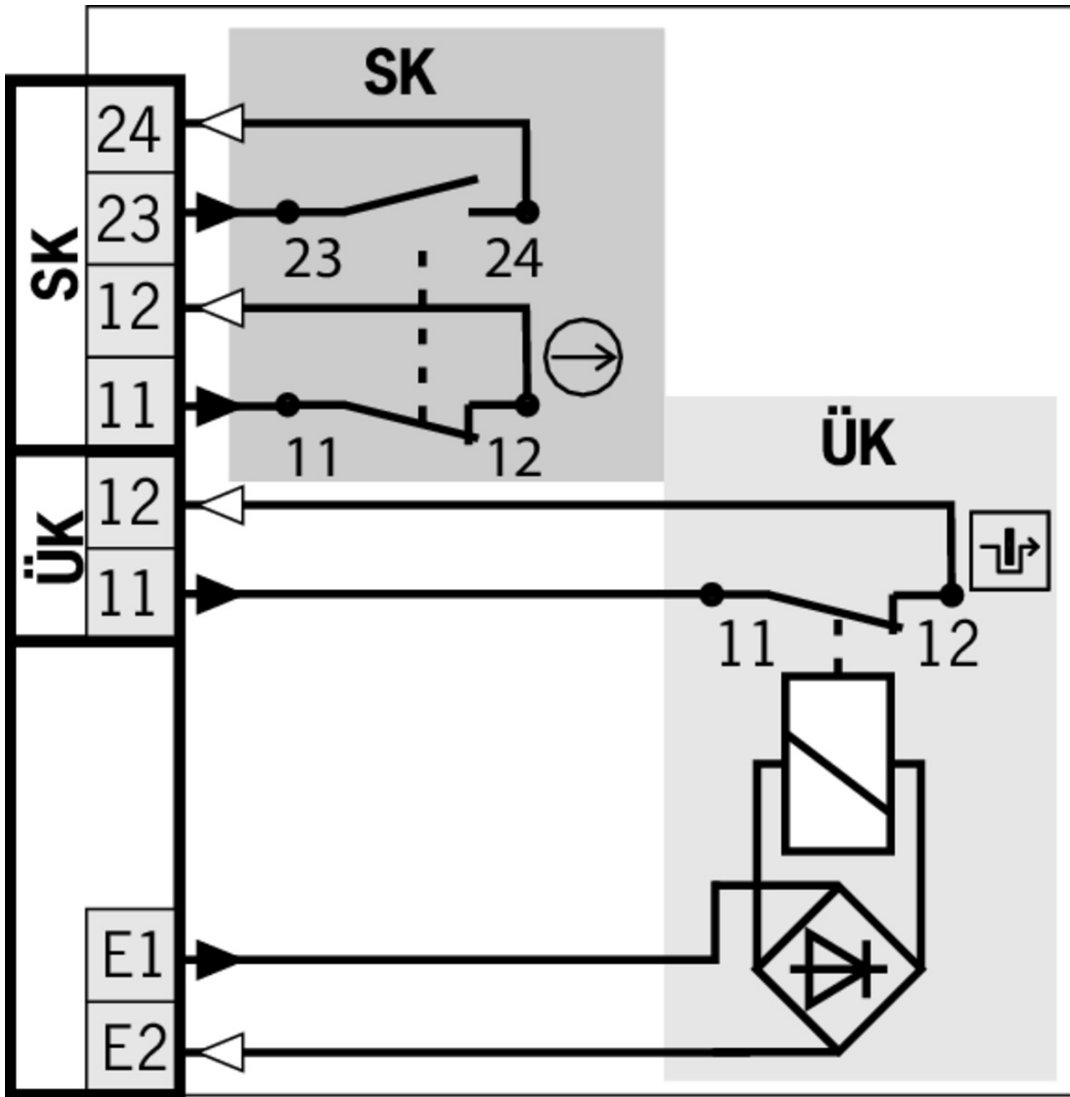

Switching functions

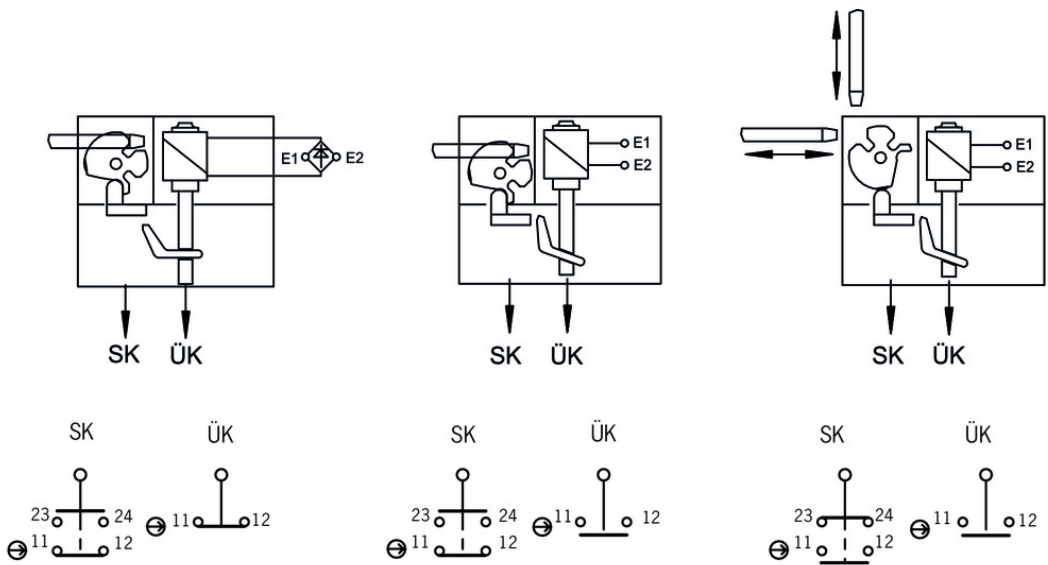

STM...242...

## Actuator

---

▼ Actuator S for safety switches SGA/SGP/STA/STP/STM



**097861** BETAETIGER-S-G-SN-C2115

▼ Features

- › Two safety screws included
  - › Physically compatible with TP actuator P-G
- 



**095738** BETAETIGER-S-GT-SN

▼ Features

- › Two safety screws included
  - › Actuators with rubber bushings
- 

▼ Actuator S, bent, for safety switches SGA/SGP/STA/STP/STM



**095740** BETAETIGER-S-WQT-SN

▼ Features

- › Two safety screws included
- 



**115073** BETAETIGER-S-W-SN-C2115

▼ Features

- › Two stainless safety screws per actuator
  - › Minimum door radius 300 mm
- 

▼ Actuator L for safety switches SGA/SGP/STA/STP/STM for insertion funnel



**095739** BETAETIGER-S-GT-LN

▼ Features

- › Two safety screws included
  - › Actuators with rubber bushings
- 

▼ Actuator L, bent, for safety switches SGA/SGP/STA/STP/STM for insertion funnel



**095741** BETAETIGER-S-WQT-LN

▼ Features

- › Two safety screws included
  - › Actuators with rubber bushings
- 

▼ Hinged actuator S top/bottom for safety switches SGA/SGP/STA/STP/STM



**095315** RADIUSBETAETIGER-S-OU-SN

▼ Features

- › Actuators made of stainless steel
  - › Two safety screws included
  - › For doors hinged at top and bottom
-

- ▼ Hinged actuator S left/right for safety switches SGA/SGP/STA/STP/STM



**096838** RADIUSBETAETIGER-S-LR-SN

▼ Features

- › Actuators made of stainless steel
- › Two safety screws included
- › For doors hinged on right and left

- ▼ Hinged actuator L top/bottom, for safety switches SGA/SGP/STA/STP/STM for insertion funnel



**096697** RADIUSBETAETIGER-S-OU-LN

▼ Features

- › Actuators made of stainless steel
- › Two stainless safety screws per actuator
- › For doors hinged at top and bottom

- ▼ Hinged actuator L left/right, for safety switches SGA/SGP/STA/STP/STM for insertion funnel



**096844** RADIUSBETAETIGER-S-LR-LN

▼ Features

- › Actuators made of stainless steel
- › Two stainless safety screws per actuator
- › For doors hinged on right and left

## Function expansion

- ▼ Insertion funnel for safety switches SGP/STA/STP/STM/SGA



**093157** EINFUEHRTRICHTER-S

- ▼ Lockout bar STA/STP/SGA/SGP/STM



**105701** SPERREINSATZ STP/STA

▼ Features

- › Prevents unintentional closing of the door
- › Can be secured with padlocks

## Connection material







- ▼ Cable glands M20x1.5



**086233** EKPM20/06 086233













## Instructions

### ▼ Betriebsanleitung Sicherheitsschalter STM...

	Doc. no.	Version	Language	Download
Betriebsanleitung Sicherheitsschalter STM...	096302	09-01/17		 5.8 MB
Manual de instrucciones Interruptores de seguridad STM...				
Mode d'emploi Interrupteur de sécurité STM...				
Istruzioni di impiego Finecorsa di sicurezza STM...				
Operating Instructions Safety Switch STM...				

## Catalogs

### ▼ Bezpečnostní spínače s plastovým pouzdrém Sicherheitsschalter mit Kunststoffgehäuse Safety Switches with Plastic Housing Interruptores de seguridad con carcasa plástica Interrupteurs de sécurité avec boîtier plastique 塑料壳体 的安全开关

	Doc. no.	Version	Language	Download
Sicherheitsschalter mit Kunststoffgehäuse	096955	11-03/18		 6.6 MB
Interrupteurs de sécurité avec boîtier plastique	100677	11-03/18		 6.6 MB
Interruptores de seguridad con carcasa plástica	104855	11-03/18		 6.6 MB
Bezpečnostní spínače s plastovým pouzdrém	121649	11-03/18		 6.6 MB
Safety Switches with Plastic Housing	096956	11-03/18		 6.6 MB
塑料壳体 的安全开关	116243	11-03/18		 6.2 MB

## Declaration of conformity

### ▼ EU prohlášení o shodě

	Doc. no.	Version	Language	Download
EU-Konformitätserklärung Declaración UE de conformidad Déclaration UE de conformité Dichiarazione di conformità EU declaration of conformity	2077153	25-02/17	    	 0.3 MB
EU prohlášení o shodě EU-overensstemmelseserklæring Δήλωση συμμόρφωσης της ΕΕ EU-vaatimustenmukaisuusvakuutus EU-típusbizonyítvány EU-conformiteitsverklaring Deklaracja zgodności UE Declaração de Conformidade UE Declarația de conformitate UE EÚ vyhlásenie o zhode	2077153	25-02/17	         	 0.5 MB

## CAD data

CAD data for this item on TraceParts