

ITEM 092259 STP4A-537A024M

Description	Technical data	Accessories	Downloads
-------------	----------------	-------------	-----------



**Features**

- › Actuating head made of metal
- › Auxiliary release on the front
- › With door monitoring contact

**Approach direction**

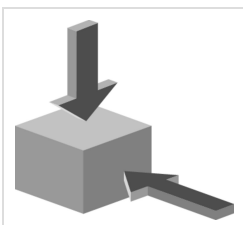

- › Figure  
Horizontal and vertical  
Can be adjusted in 90° steps

**Solenoid operating voltage**

- › AC/DC 24 V +10%, -15%

## Guard locking type

**STP4** Open-circuit current principle, guard locking by applying voltage to the guard locking solenoid. Release by spring force.

---

## Switching element

**537** Slow-action switching contact 1 NC  $\ominus$  + 1 NC (door monitoring contact)

---

## Auxiliary release

Is used for releasing the guard locking with the aid of a tool. To protect against tampering, the auxiliary release is sealed with sealing lacquer.

## Approvals



## Mechanical values and environment

Ambient temperature	-20 ... 55 °C
Mechanical life	1 x 10 <sup>6</sup>
Number of door position NC contacts	1
Number of guard lock monitoring positively driven contacts	1
Actuation frequency	1200 1/h
Locking force F <sub>max</sub>	2500 N
Locking force F <sub>Zh</sub>	2000 N
Retention force	20 N
Extraction force	30 N
Actuating force	35 N
Insertion depth	min.24,5 mm

## Electrical connection ratings

Rated thermal current I <sub>th</sub>	4 A
Utilization category according to EN 60947-5-1	AC-15 DC-13
Rated insulation voltage U <sub>i</sub>	250 V
Rated impulse withstand voltage U <sub>imp</sub>	2,5 kV
Power consumption	8 W
Solenoid duty cycle	100 %
Connection cross-section	0,34 ... 1,5 mm <sup>2</sup>

in combination with Actuator BETAETIGER-S-GT-SN

## Mechanical values and environment

Overtravel 5 mm

### Dimension drawing

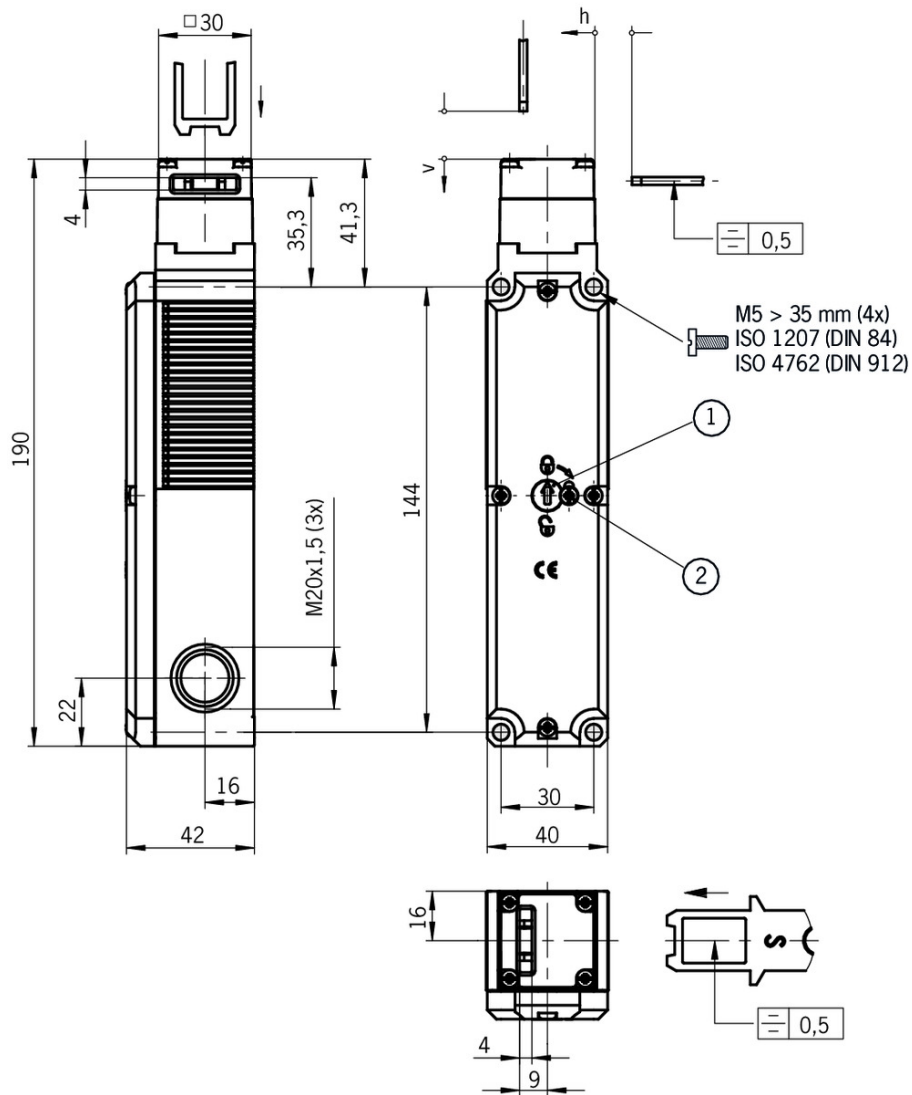

### Legende

- 1 Auxiliary release
- 2 Locking screw

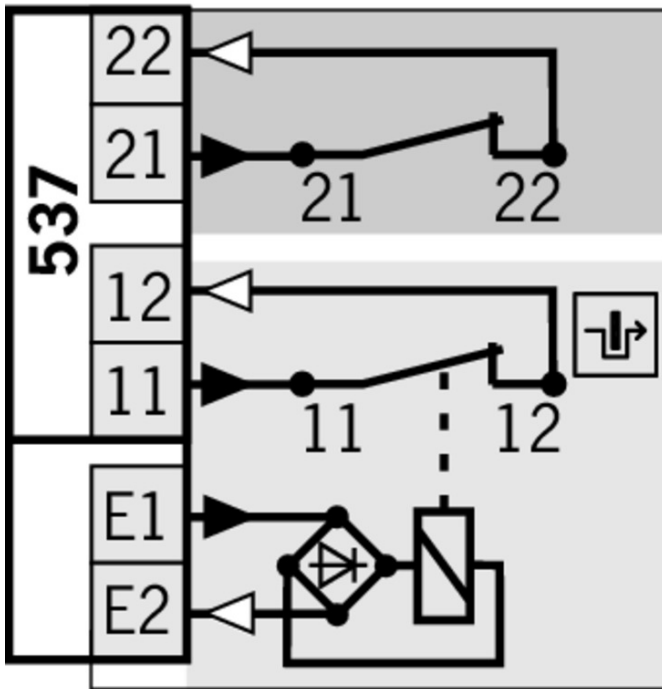

**Legende**

- Solenoid monitoring
- Door monitoring

## Switching functions

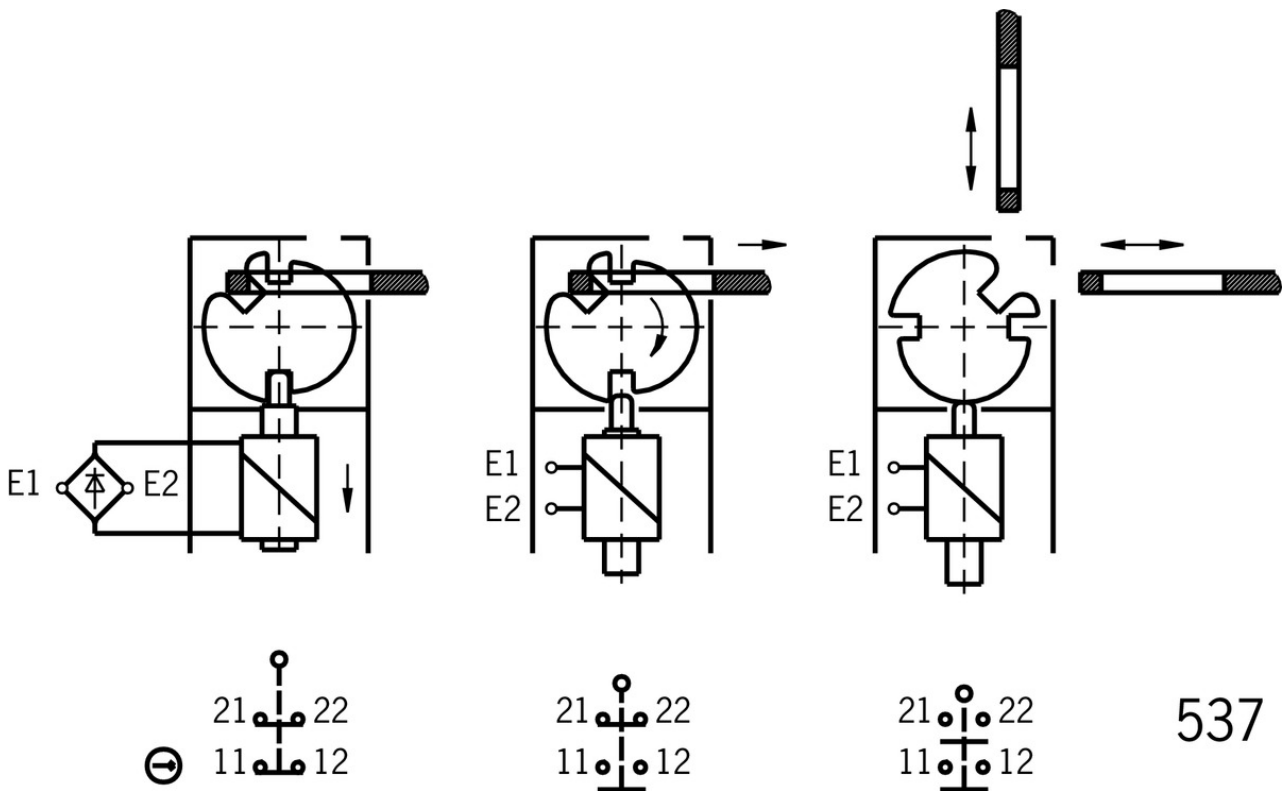

## Actuator

- ✓ Actuator S for safety switches SGA/SGP/STA/STP/STM



**097861** BETAETIGER-S-G-SN-C2115

✓ Features

- › Two safety screws included
- › Physically compatible with TP actuator P-G



**095738** BETAETIGER-S-GT-SN

✓ Features

- › Two safety screws included
- › Actuators with rubber bushings

- ✓ Actuator S, bent, for safety switches SGA/SGP/STA/STP/STM



**095740** BETAETIGER-S-WQT-SN

✓ Features

- › Two safety screws included



**115073** BETAETIGER-S-W-SN-C2115

✓ Features

- › Two stainless safety screws per actuator
- › Minimum door radius 300 mm

**105808** BETAETIGER-S-WT-SN-C2115



- ✓ Features
    - › Two stainless safety screws per actuator
    - › Actuators with rubber bushings
    - › Minimum door radius 300 mm
- 

- ✓ Actuator L, bent, for safety switches SGA/SGP/STA/STP/STM for insertion funnel



- ✓ **095741** BETAETIGER-S-WQT-LN
  - ✓ Features
    - › Two safety screws included
    - › Actuators with rubber bushings
- 



- ✓ **105809** BETAETIGER-S-WT-LN-C2115
  - ✓ Features
    - › Two stainless safety screws per actuator
    - › Actuators with rubber bushings
    - › Minimum door radius 300 mm
- 

- ✓ Actuator L for safety switches SGA/SGP/STA/STP/STM for insertion funnel



- ✓ **095739** BETAETIGER-S-GT-LN
  - ✓ Features
    - › Two safety screws included
    - › Actuators with rubber bushings
- 

- ✓ Hinged actuator S top/bottom for safety switches SGA/SGP/STA/STP/STM



- ✓ **095315** RADIUSBETAETIGER-S-OU-SN
  - ✓ Features
    - › Actuators made of stainless steel
    - › Two safety screws included
    - › For doors hinged at top and bottom
- 

- ✓ Hinged actuator S left/right for safety switches SGA/SGP/STA/STP/STM



- ✓ **096838** RADIUSBETAETIGER-S-LR-SN
  - ✓ Features
    - › Actuators made of stainless steel
    - › Two safety screws included
    - › For doors hinged on right and left
- 

- ✓ Hinged actuator L top/bottom, for safety switches SGA/SGP/STA/STP/STM for insertion funnel



- ✓ **096697** RADIUSBETAETIGER-S-OU-LN
  - ✓ Features
    - › Actuators made of stainless steel
    - › Two stainless safety screws per actuator
    - › For doors hinged at top and bottom
-

- ▼ Hinged actuator L left/right, for safety switches SGA/SGP/STA/STP/STM for insertion funnel



**096844** RADIUSBETAETIGER-S-LR-LN

▼ Features

- › Actuators made of stainless steel
- › Two stainless safety screws per actuator
- › For doors hinged on right and left

---

## Function expansion

- ▼ Insertion funnel for safety switches SGP/STA/STP/STM/SGA



**093157** EINFUEHRTRICHTER-S

- ▼ LED set



**098035** STP LED SET

- ▼ Built-in LED



**087423** EINBAULEUCHTE LED M20X1,5



**095510** EINBAULEUCHTE LED-F M20X1,5

- ▼ Lock for auxiliary release for safety switches CTP/TP/STP



**084177** SCHLOSS TP VERSCHIEDENSCHLIESSEND

▼ Features

- › Lock unique locking
- › Key removable in “unlocked” and “locked” positions



**086236** SCHLOSS TP GLEICHSCHLIESSEND

▼ Features

- › Identical locking
- › Key removable in “unlocked” and “locked” positions



**109212** SCHLOSS TP GLEICHSCHLIESSEND C2293

▼ Features

- › Identical locking
- › Key can be removed only in “locked” position

- ▼ Emergency unlocking for safety switches CTP/TP/STP

**099877** NOTENTSPERRUNG TP/STP



Release with automatic reset for safety switches CTP/TP/STP



**103110** ENTRIEGELUNG RUECKSTELLEND TP/STP



Handle for wire front release



**099795** AY-HDL-099795

Features

- › Suitable for all wire front releases



Lockout bar STA/STP/SGA/SGP/STM



**105701** SPERREINSATZ STP/STA

Features

- › Prevents unintentional closing of the door
- › Can be secured with padlocks



Handle for escape release for safety switches TP/STP/STA



**105329** FE-GRIFF



Wire front release



**096230** AE-B-A1-02,0-096230

Features

- › Can be used as escape release or emergency unlocking
- › No automatic return
- › Sheath length 2 m (rope length 6 m)



**097747** AE-B-A1-02,0-F-097747

Features

- › Can be used as escape release or emergency unlocking
- › automatic return
- › Sheath length 2 m (rope length 6 m)



**111233** AE-B-A1-03,0-F-111233

Features

- › Can be used as escape release or emergency unlocking
- › automatic return
- › Sheath length 3 m (rope length 6 m)



**098313** AE-B-A1-03,0-098313

Features

- › Can be used as escape release or emergency unlocking
- › No automatic return
- › Sheath length 3 m (rope length 6 m)





**098314** AE-B-A1-04,0-098314

▼ Features

- › Can be used as escape release or emergency unlocking
- › No automatic return
- › Sheath length 4 m (rope length 6 m)



**124770** AE-B-A1-06,0-F-124770

▼ Features

- › Can be used as escape release or emergency unlocking
- › automatic return
- › Rope length 6 m (without sheath)



**125582** AE-B-A1-06,0-125582

▼ Features

- › Can be used as escape release or emergency unlocking
- › No automatic return
- › Rope length 6 m (without sheath)

## Mounting accessories

- ▼ Mounting plates EMP-B1 for actuators for safety switches CTP, TP...A, STA, STP, TX and TZ



**093457** EMP-B1

- ▼ Mounting plates EMP-SB for safety switches CTP, TP...A, STA, STP and TX



**093456** EMP-SB

▼ Features

- › For vertical and horizontal mounting of safety switches TP...A, STA, STP and TX

- ▼ Mounting plates EMP-B2 for actuators for safety switches CTP, TP...A, STA, STP, TX and TZ



**093458** EMP-B2

- ▼ Switch bracket TP/STP GFK



**096613** SCHALTERAUFNAHME TP/STP GFK

▼ Features

- › Switch bracket made of fiber glass reinforced plastic
- › For left or right hinged doors

## Spare parts

- ▼ Replacement key for mechanical key release



**099434** ERSATZSCHLUESSEL GLEICHSCHL.0354

---

## Bolt

---

▼ Bolt S-... for safety switches STA, STP, SGP and SGA



**096384** RIEGEL S-A

▼ Features

- › Steel bolt
  - › For doors hinged on the right
  - › Can be locked in open position with padlocks
  - › Actuator included
- 



**096385** RIEGEL S-C

▼ Features

- › Steel bolt
  - › For doors hinged on the left
  - › Can be locked in open position with padlocks
  - › Actuator included
- 

▼ Bolt STP-GFK for safety switches STA, STP, SGP and SGA



**098121** RIEGEL STP-GFK

▼ Features

- › Fiber glass reinforced plastic bolt
  - › For doors hinged on the left or right
  - › Can be locked in open position with padlocks
  - › Actuator included
- 

▼ Bolt BTC-ST/G... without escape release for safety switches STA, STP, SGP and SGA



**106284** BTC-ST/G-S-TH-00-X

▼ Features

- › Aluminum bolt
  - › For doors hinged on the left or right
  - › Can be locked in open position with padlocks
  - › Actuator included
- 

## Connection material

---

▼ Cable glands M20x1.5



**086233** EKPM20/06 086233

---













## Instructions

### Инструкция по эксплуатации предохранительных выключателей STP...

	Doc. no.	Version	Language	Download
Betriebsanleitung Sicherheitsschalter STP... Manual de instrucciones del interruptor de seguridad STP... Mode d'emploi pour les interrupteurs de sécurité STP... Operating Instructions Safety Switches STP...	2095803	09-12/17	   	 6.4 MB
Инструкция по эксплуатации предохранительных выключателей STP...	2095803	09-12/17		 1.8 MB
İşletim kılavuzu Emniyet şalteri STP...	2095803	09-12/17		 1.8 MB
Istruzioni di impiego dei finecorsa di sicurezza STP...	2095803	09-12/17		 1.7 MB

## Catalogs

### Bezpečnostní spínače s plastovým pouzdem Sicherheitsschalter mit Kunststoffgehäuse Safety Switches with Plastic Housing Interruptores de seguridad con carcasa plástica Interrupteurs de sécurité avec boîtier plastique 塑料壳体 的安全开关

	Doc. no.	Version	Language	Download
Sicherheitsschalter mit Kunststoffgehäuse	096955	11-03/18		 6.6 MB
Interrupteurs de sécurité avec boîtier plastique	100677	11-03/18		 6.6 MB
Interruptores de seguridad con carcasa plástica	104855	11-03/18		 6.6 MB
Bezpečnostní spínače s plastovým pouzdem	121649	11-03/18		 6.6 MB
Safety Switches with Plastic Housing	096956	11-03/18		 6.6 MB
塑料壳体 的安全开关	116243	11-03/18		 6.2 MB

## Declaration of conformity

### EU prohlášení o shodě

	Doc. no.	Version	Language	Download
EU-Konformitätserklärung Declaración UE de conformidad Déclaration UE de conformité Dichiarazione di conformità EU declaration of conformity	2077153	25-02/17	    	 0.3 MB
EU prohlášení o shodě EU-overensstemmelseserklæring Δήλωση συμμόρφωσης της ΕΕ EU-vaatimustenmukaisuusvakuutus EU-típusbizonyítvány EU-conformiteitsverklaring Deklaracja zgodności UE Declaração de Conformidade UE Declarația de conformitate UE EÚ vyhlásenie o zhode	2077153	25-02/17	         	 0.5 MB

## CAD data

