

ITEM 099326 STP3A-2131A110M

Description	Technical data	Accessories	Downloads
-------------	----------------	-------------	-----------



Features

- › Actuating head made of metal
- › Auxiliary release on the front
- › With door monitoring contact

Approach direction



- › Figure
Horizontal and vertical
Can be adjusted in 90° steps

Solenoid operating voltage

- › AC 110 V +10%, -15%

Guard locking type

STP3 Closed-circuit current principle, guard locking by spring force. Release by applying voltage to the guard locking solenoid.

Switching element

2131 Slow-action switching contact 2 NC \oplus + 1 NO + 1 NC (door monitoring contact)

Auxiliary release

Is used for releasing the guard locking with the aid of a tool. To protect against tampering, the auxiliary release is sealed with sealing lacquer.

Approvals



Mechanical values and environment

Ambient temperature	-20 ... 55 °C
Mechanical life	1 x 10 ⁶
Number of door position NC contacts	1
Number of guard lock monitoring positively driven contacts	2
Number of guard lock monitoring NO contacts	1
Actuation frequency	1200 1/h
Locking force F _{max}	2500 N
Locking force F _{Zh}	2000 N
Retention force	20 N
Extraction force	30 N
Actuating force	35 N
Insertion depth	min.24,5 mm

Electrical connection ratings

Rated thermal current I _{th}	4 A
Utilization category according to EN 60947-5-1	AC-15 DC-13
Rated insulation voltage U _i	250 V
Rated impulse withstand voltage U _{imp}	2,5 kV
Power consumption	10 W

Solenoid duty cycle	100 %
Connection cross-section	0,34 ... 1,5 mm ²

in combination with Actuator BETAETIGER-S-GT-SN

Mechanical values and environment

Overtravel	5 mm
------------	------

Dimension drawing

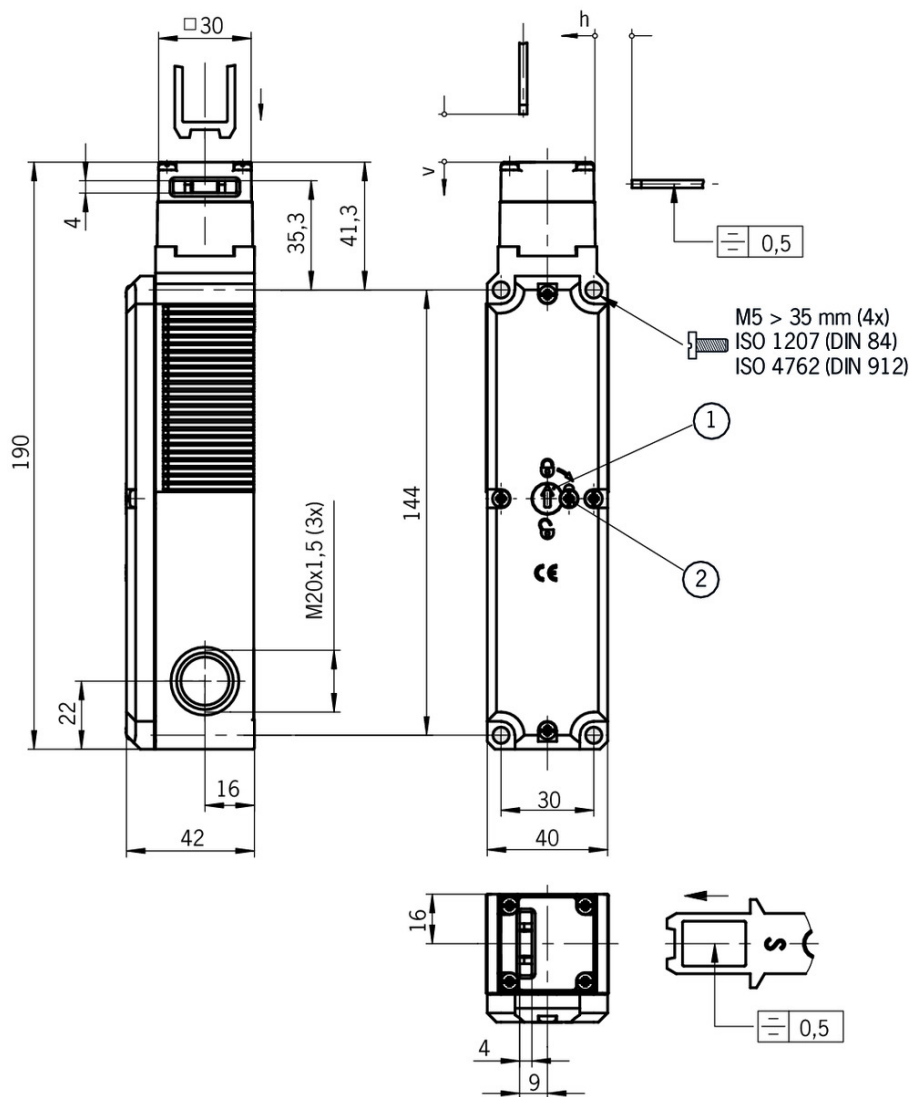

Legende

- 1 Auxiliary release
- 2 Locking screw

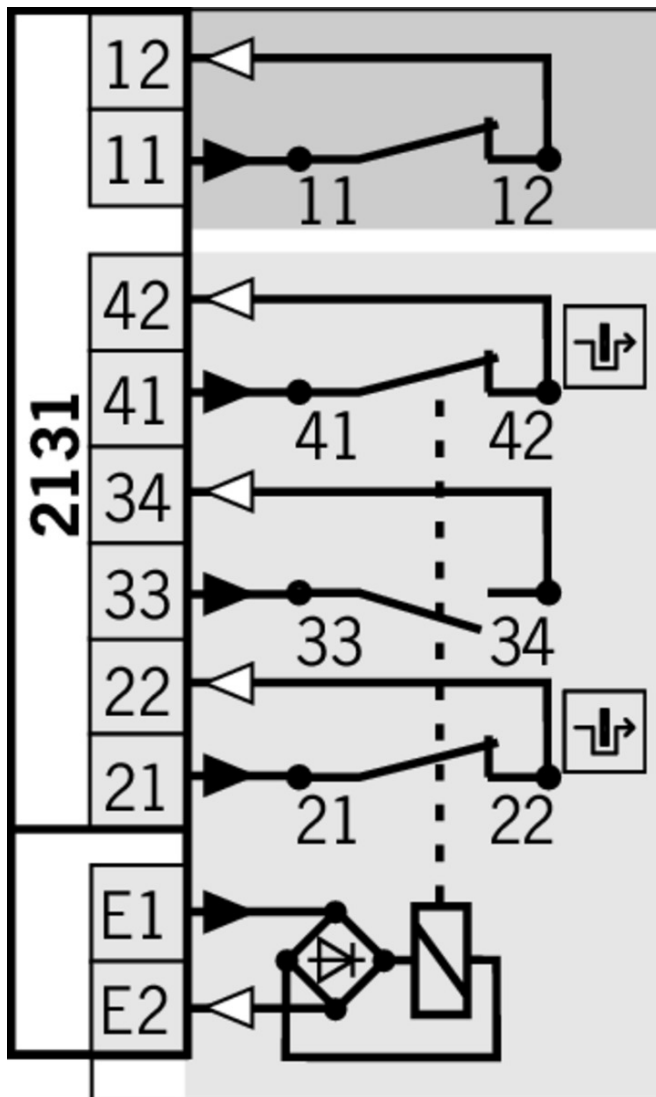

Legende

- Solenoid monitoring
- Door monitoring

Switching functions

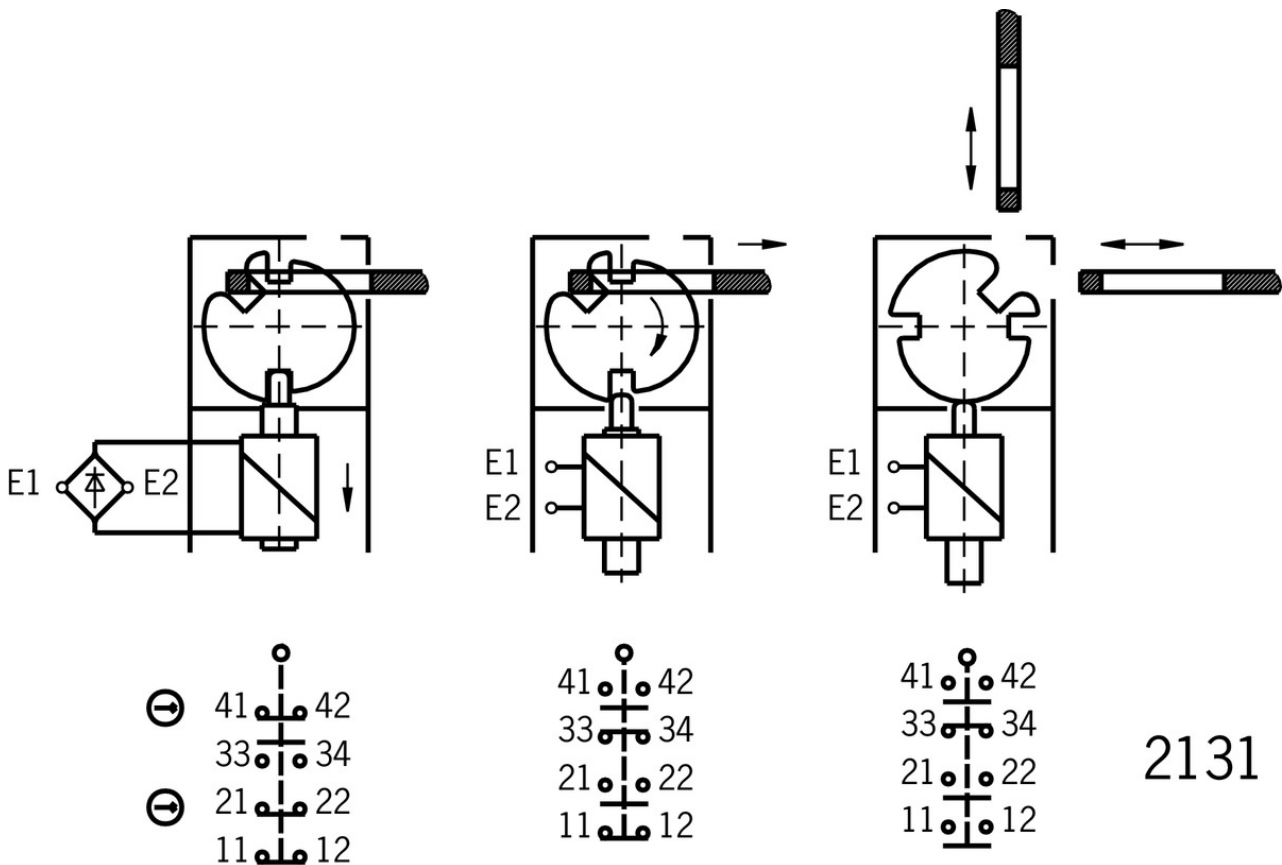

2131

Function expansion

✓ Built-in LED



095510 EINBAULEUCHTE LED-F M20X1,5



087423 EINBAULEUCHTE LED M20X1,5

✓ Lock for auxiliary release for safety switches CTP/TP/STP



084177 SCHLOSS TP VERSCHIEDENSCHLIESSEND

✓ Features

- › Lock unique locking
- › Key removable in “unlocked” and “locked” positions



086236 SCHLOSS TP GLEICHSCHLIESSEND

✓ Features

- › Identical locking
- › Key removable in “unlocked” and “locked” positions

109212 SCHLOSS TP GLEICHSCHLIESSEND C2293

✓ Features



- › Identical locking
 - › Key can be removed only in “locked” position
-

▼ LED set



098035 STP LED SET

▼ Insertion funnel for safety switches SGP/STA/STP/STM/SGA



093157 EINFUEHRTRICHTER-S

▼ Lockout bar STA/STP/SGA/SGP/STM



105701 SPERREINSATZ STP/STA

▼ Features

- › Prevents unintentional closing of the door
 - › Can be secured with padlocks
-

▼ Emergency unlocking for safety switches CTP/TP/STP



099877 NOTENTSPERRUNG TP/STP

▼ Release with automatic reset for safety switches CTP/TP/STP



103110 ENTRIEGELUNG RUECKSTELLEND TP/STP

▼ Handle for wire front release



099795 AY-HDL-099795

▼ Features

- › Suitable for all wire front releases
-

▼ Handle for escape release for safety switches TP/STP/STA



105329 FE-GRIFF

▼ Wire front release



096230 AE-B-A1-02,0-096230

▼ Features

- › Can be used as escape release or emergency unlocking
 - › No automatic return
 - › Sheath length 2 m (rope length 6 m)
-



097747 AE-B-A1-02,0-F-097747

✓ Features

- › Can be used as escape release or emergency unlocking
- › automatic return
- › Sheath length 2 m (rope length 6 m)



098313 AE-B-A1-03,0-098313

✓ Features

- › Can be used as escape release or emergency unlocking
- › No automatic return
- › Sheath length 3 m (rope length 6 m)



111233 AE-B-A1-03,0-F-111233

✓ Features

- › Can be used as escape release or emergency unlocking
- › automatic return
- › Sheath length 3 m (rope length 6 m)



098314 AE-B-A1-04,0-098314

✓ Features

- › Can be used as escape release or emergency unlocking
- › No automatic return
- › Sheath length 4 m (rope length 6 m)



124770 AE-B-A1-06,0-F-124770

✓ Features

- › Can be used as escape release or emergency unlocking
- › automatic return
- › Rope length 6 m (without sheath)



125582 AE-B-A1-06,0-125582

✓ Features

- › Can be used as escape release or emergency unlocking
- › No automatic return
- › Rope length 6 m (without sheath)

Spare parts

- ✓ Replacement key for mechanical key release



099434 ERSATZSCHLUESSEL GLEICHSCHL.0354

Mounting accessories

- ✓ Mounting plates EMP-B1 for actuators for safety switches CTP, TP...A, STA, STP, TX and TZ

093457 EMP-B1



Mounting plates EMP-B2 for actuators for safety switches CTP, TP...A, STA, STP, TX and

093458 EMP-B2

Mounting plates EMP-SB for safety switches CTP, TP...A, STA, STP and TX



093456 EMP-SB

Features

- › For vertical and horizontal mounting of safety switches TP...A, STA, STP and TX

Switch bracket TP/STP GFK



096613 SCHALTERAUFNAHME TP/STP GFK

Features

- › Switch bracket made of fiber glass reinforced plastic
- › For left or right hinged doors

Actuator

Hinged actuator L top/bottom, for safety switches SGA/SGP/STA/STP/STM for insertion funnel



096697 RADIUSBETAETIGER-S-OU-LN

Features

- › Actuators made of stainless steel
- › Two stainless safety screws per actuator
- › For doors hinged at top and bottom

Hinged actuator L left/right, for safety switches SGA/SGP/STA/STP/STM for insertion funnel



096844 RADIUSBETAETIGER-S-LR-LN

Features

- › Actuators made of stainless steel
- › Two stainless safety screws per actuator
- › For doors hinged on right and left

Hinged actuator S left/right for safety switches SGA/SGP/STA/STP/STM



096838 RADIUSBETAETIGER-S-LR-SN

Features

- › Actuators made of stainless steel
- › Two safety screws included
- › For doors hinged on right and left

Hinged actuator S top/bottom for safety switches SGA/SGP/STA/STP/STM



095315 RADIUSBETAETIGER-S-OU-SN

✓ Features

- › Actuators made of stainless steel
 - › Two safety screws included
 - › For doors hinged at top and bottom
-

✓ Actuator L for safety switches SGA/SGP/STA/STP/STM for insertion funnel



095739 BETAETIGER-S-GT-LN

✓ Features

- › Two safety screws included
 - › Actuators with rubber bushings
-

✓ Actuator L, bent, for safety switches SGA/SGP/STA/STP/STM for insertion funnel



095741 BETAETIGER-S-WQT-LN

✓ Features

- › Two safety screws included
 - › Actuators with rubber bushings
-



105809 BETAETIGER-S-WT-LN-C2115

✓ Features

- › Two stainless safety screws per actuator
 - › Actuators with rubber bushings
 - › Minimum door radius 300 mm
-

✓ Actuator S for safety switches SGA/SGP/STA/STP/STM



095738 BETAETIGER-S-GT-SN

✓ Features

- › Two safety screws included
 - › Actuators with rubber bushings
-



097861 BETAETIGER-S-G-SN-C2115

✓ Features

- › Two safety screws included
 - › Physically compatible with TP actuator P-G
-

✓ Actuator S, bent, for safety switches SGA/SGP/STA/STP/STM



095740 BETAETIGER-S-WQT-SN

✓ Features

- › Two safety screws included
-



115073 BETAETIGER-S-W-SN-C2115

✓ Features

- › Two stainless safety screws per actuator
 - › Minimum door radius 300 mm
-



105808 BETAETIGER-S-WT-SN-C2115

✓ Features

- › Two stainless safety screws per actuator
 - › Actuators with rubber bushings
 - › Minimum door radius 300 mm
-

Bolt

✓ Bolt BTC-ST/G... without escape release for safety switches STA, STP, SGP and SGA



106284 BTC-ST/G-S-TH-00-X

✓ Features

- › Aluminum bolt
 - › For doors hinged on the left or right
 - › Can be locked in open position with padlocks
 - › Actuator included
-

✓ Bolt S-... for safety switches STA, STP, SGP and SGA



096384 RIEGEL S-A

✓ Features

- › Steel bolt
 - › For doors hinged on the right
 - › Can be locked in open position with padlocks
 - › Actuator included
-



096385 RIEGEL S-C

✓ Features

- › Steel bolt
 - › For doors hinged on the left
 - › Can be locked in open position with padlocks
 - › Actuator included
-

✓ Bolt STP-GFK for safety switches STA, STP, SGP and SGA





098121 RIEGEL STP-GFK

✓ Features

- › Fiber glass reinforced plastic bolt
 - › For doors hinged on the left or right
 - › Can be locked in open position with padlocks
 - › Actuator included
-













Instructions

✓ Инструкция по эксплуатации предохранительных выключателей STP...

Betriebsanleitung Sicherheitsschalter STP... Manual de instrucciones del interruptor de seguridad STP... Mode d'emploi pour les interrupteurs de sécurité STP... Operating Instructions Safety Switches STP...	2095803	09-12/17	   	 6.4 MB
Инструкция по эксплуатации предохранительных выключателей STP...	2095803	09-12/17		 1.8 MB
İşletim kılavuzu Emniyet şalteri STP...	2095803	09-12/17		 1.8 MB
Istruzioni di impiego dei finecorsa di sicurezza STP...	2095803	09-12/17		 1.7 MB

Catalogs

- Bezpečnostní spínače s plastovým pouzdrém Sicherheitsschalter mit Kunststoffgehäuse Safety Switches with Plastic Housing Interruptores de seguridad con carcasa plástica Interrupteurs de sécurité avec boîtier plastique 塑料壳体 的安全开关

	Doc. no.	Version	Language	Download
Sicherheitsschalter mit Kunststoffgehäuse	096955	11-03/18		 6.6 MB
Interrupteurs de sécurité avec boîtier plastique	100677	11-03/18		 6.6 MB
Interruptores de seguridad con carcasa plástica	104855	11-03/18		 6.6 MB
Bezpečnostní spínače s plastovým pouzdrém	121649	11-03/18		 6.6 MB
Safety Switches with Plastic Housing	096956	11-03/18		 6.6 MB
塑料壳体 的安全开关	116243	11-03/18		 6.2 MB

Declaration of conformity

- EU prohlášení o shodě

	Doc. no.	Version	Language	Download
EU-Konformitätserklärung Declaración UE de conformidad Déclaration UE de conformité Dichiarazione di conformità EU declaration of conformity	2077153	25-02/17	    	 0.3 MB
EU prohlášení o shodě EU-overensstemmelseserklæring Δήλωση συμμόρφωσης της ΕΕ EU-vaatimustenmukaisuusvakuutus EU-típusbizonyítvány EU-conformiteitsverklaring Deklaracja zgodności UE Declaração de Conformidade UE Declarația de conformitate UE EÚ vyhlásenie o zhode	2077153	25-02/17	        	 0.5 MB

CAD data

CAD data for this item on TraceParts