

## ITEM 100746 STP-TW-3A-4141AC024M

Description	Technical data	Accessories	Downloads
-------------	----------------	-------------	-----------



### Features

- › Two actuating heads made of metal
- › Simultaneous monitoring of two safety doors
- › Auxiliary release on the front
- › With door monitoring contact

### Approach direction

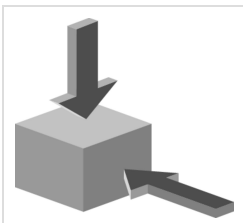

- › Figure  
Horizontal and vertical  
Can be adjusted in 90° steps

### Solenoid operating voltage

- › AC/DC 24 V +10%, -15%

## Guard locking type

**STP3** Closed-circuit current principle, guard locking by spring force. Release by applying voltage to the guard locking solenoid.

## Switching element

**4141** Slow-action switching contact 2 NC  $\ominus$  + 2 NC  $\ominus$  (door monitoring contact)

## Auxiliary release

Is used for releasing the guard locking with the aid of a tool. To protect against tampering, the auxiliary release is sealed with sealing lacquer.

## Approvals



## Mechanical values and environment

Ambient temperature	-20 ... 55 °C
Mechanical life	1 x 10 <sup>6</sup>
Number of door position positively driven contacts	2
Number of guard lock monitoring positively driven contacts	2
Actuation frequency	1200 1/h
Locking force F <sub>max</sub>	2500 N
Locking force F <sub>Zh</sub>	2000 N
Retention force	20 N
Extraction force	30 N
Actuating force	35 N
Insertion depth	min.24,5 mm

## Electrical connection ratings

Rated thermal current I <sub>tH</sub>	4 A
Utilization category according to EN 60947-5-1	AC-15 DC-13
Rated insulation voltage U <sub>i</sub>	250 V
Rated impulse withstand voltage U <sub>imp</sub>	2,5 kV
Power consumption	8 W
Solenoid duty cycle	100 %

Connection cross-section

0,34 ... 1,5 mm<sup>2</sup>

in combination with Actuator BETAETIGER-S-GT-SN

### Mechanical values and environment

Overtravel

5 mm

### Dimension drawing

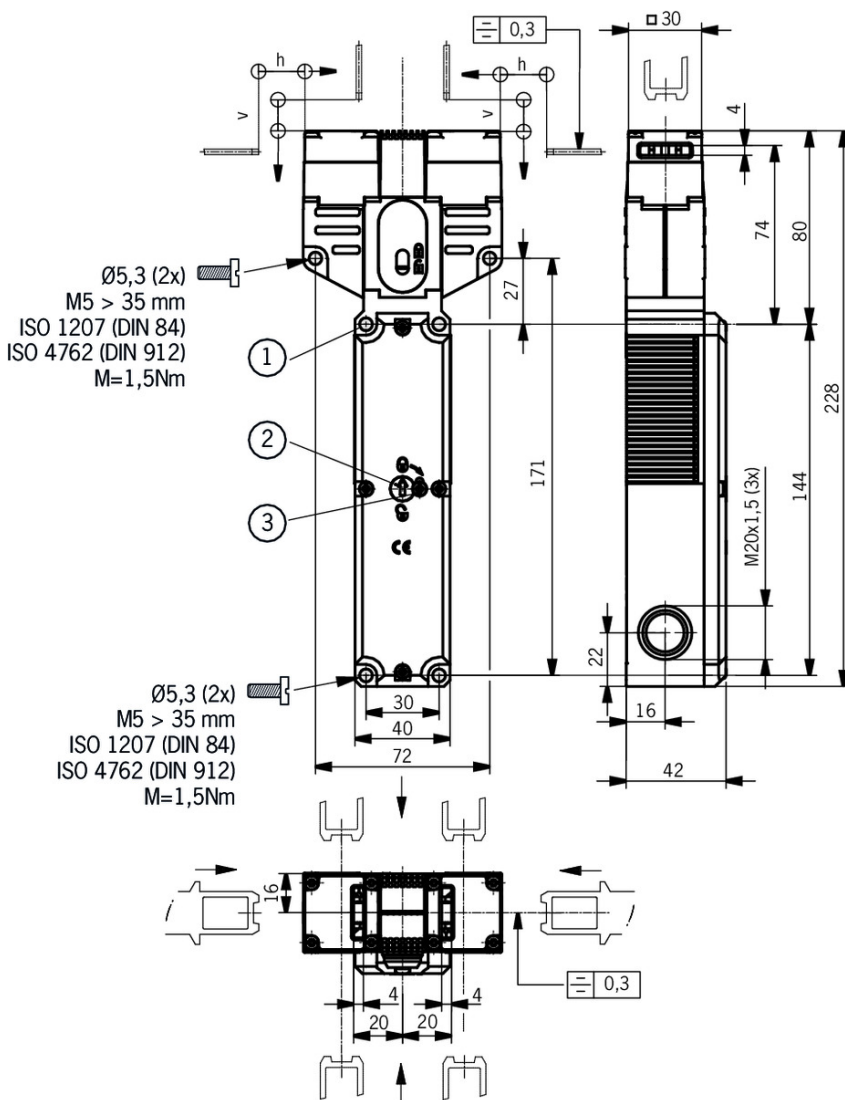

### Legende

1 Do not screw tight here (2x)

2 Auxiliary release

3 Locking screw

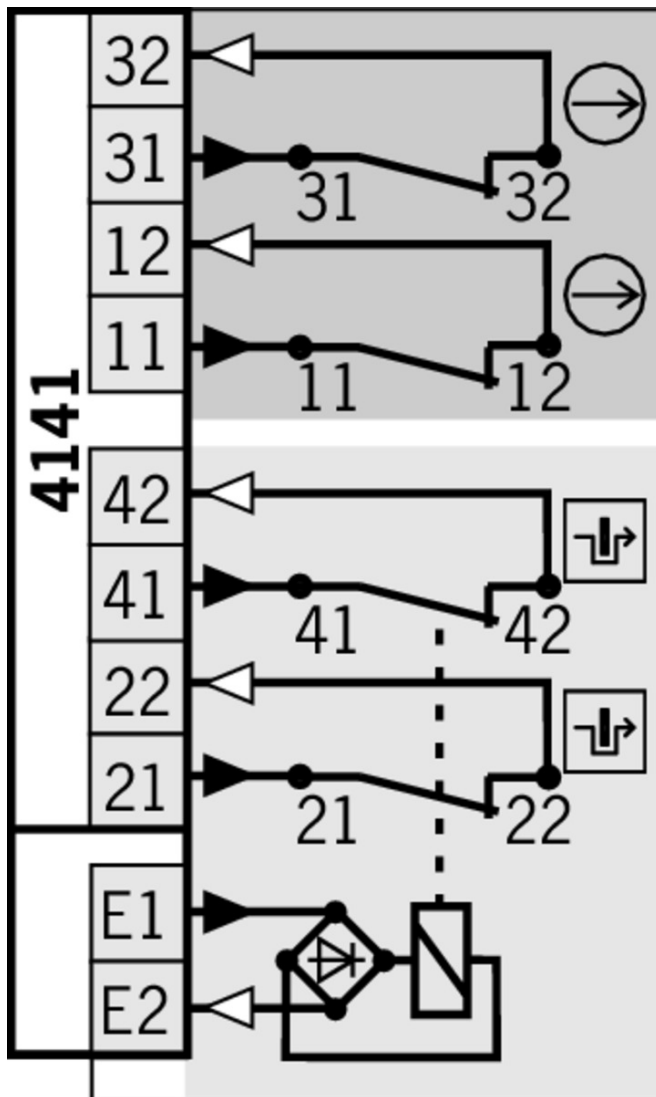

**Legende**

- Solenoid monitoring
- Door monitoring

## Switching functions

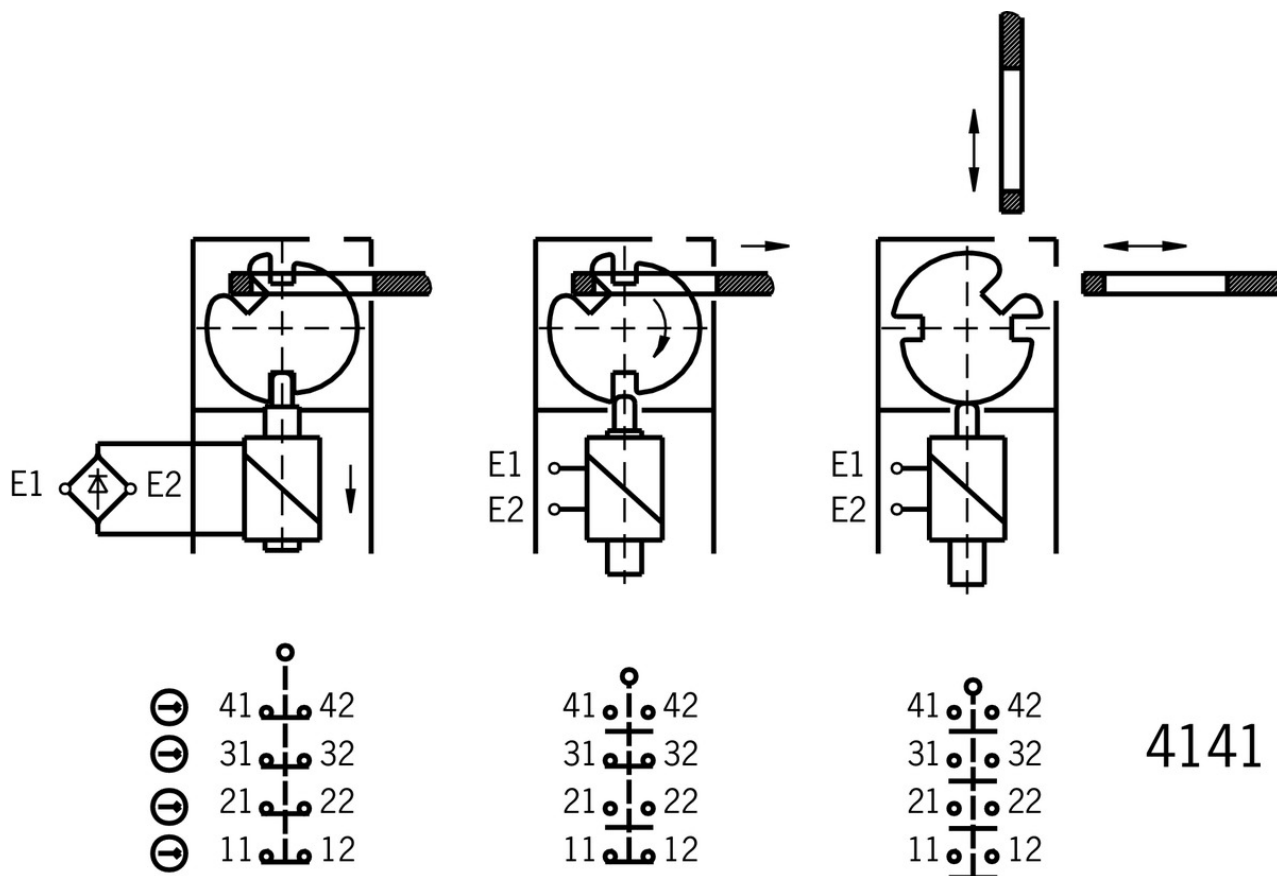

## Actuator

Actuator S for safety switches SGA/SGP/STA/STP/STM



**097861** BETAETIGER-S-G-SN-C2115

Features

- › Two safety screws included
- › Physically compatible with TP actuator P-G



**095738** BETAETIGER-S-GT-SN

Features

- › Two safety screws included
- › Actuators with rubber bushings

Actuator S, bent, for safety switches SGA/SGP/STA/STP/STM



**095740** BETAETIGER-S-WQT-SN

Features

- › Two safety screws included



**115073** BETAETIGER-S-W-SN-C2115

Features

- › Two stainless safety screws per actuator
- › Minimum door radius 300 mm



**105808** BETAETIGER-S-WT-SN-C2115

✓ Features

- › Two stainless safety screws per actuator
- › Actuators with rubber bushings
- › Minimum door radius 300 mm

✓ Hinged actuator S top/bottom for safety switches SGA/SGP/STA/STP/STM



**095315** RADIUSBETAETIGER-S-OU-SN

✓ Features

- › Actuators made of stainless steel
- › Two safety screws included
- › For doors hinged at top and bottom

✓ Hinged actuator S left/right for safety switches SGA/SGP/STA/STP/STM



**096838** RADIUSBETAETIGER-S-LR-SN

✓ Features

- › Actuators made of stainless steel
- › Two safety screws included
- › For doors hinged on right and left

✓ Actuator L, bent, for safety switches SGA/SGP/STA/STP/STM for insertion funnel



**105809** BETAETIGER-S-WT-LN-C2115

✓ Features

- › Two stainless safety screws per actuator
- › Actuators with rubber bushings
- › Minimum door radius 300 mm

## Function expansion

✓ LED set



**098035** STP LED SET

✓ Built-in LED



**087423** EINBAULEUCHTE LED M20X1,5



**095510** EINBAULEUCHTE LED-F M20X1,5

✓ Lock for auxiliary release for safety switches CTP/TP/STP

**084177** SCHLOSS TP VERSCHIEDENSCHLIESSEND



- ✓ Features
    - › Lock unique locking
    - › Key removable in “unlocked” and “locked” positions
- 



- 086236** SCHLOSS TP GLEICHSCHLIESSEND
- ✓ Features
    - › Identical locking
    - › Key removable in “unlocked” and “locked” positions
- 



- 109212** SCHLOSS TP GLEICHSCHLIESSEND C2293
- ✓ Features
    - › Identical locking
    - › Key can be removed only in “locked” position
- 

- ✓ Release with automatic reset for safety switches CTP/TP/STP



- 103110** ENTRIEGELUNG RUECKSTELLEND TP/STP
- 

- ✓ Handle for wire front release



- 099795** AY-HDL-099795
- ✓ Features
    - › Suitable for all wire front releases
- 

- ✓ Lockout bar STA/STP/SGA/SGP/STM



- 105701** SPERREINSATZ STP/STA
- ✓ Features
    - › Prevents unintentional closing of the door
    - › Can be secured with padlocks
- 

- ✓ Emergency unlocking for safety switches CTP/TP/STP



- 099877** NOTENTSPERRUNG TP/STP
- 

- ✓ Handle for escape release for safety switches TP/STP/STA



- 105329** FE-GRIFF
- 

- ✓ Wire front release



- 125582** AE-B-A1-06,0-125582
- ✓ Features
    - › Can be used as escape release or emergency unlocking
    - › No automatic return
    - › Rope length 6 m (without sheath)



**124770** AE-B-A1-06,0-F-124770

✓ Features

- › Can be used as escape release or emergency unlocking
- › automatic return
- › Rope length 6 m (without sheath)



**098314** AE-B-A1-04,0-098314

✓ Features

- › Can be used as escape release or emergency unlocking
- › No automatic return
- › Sheath length 4 m (rope length 6 m)



**098313** AE-B-A1-03,0-098313

✓ Features

- › Can be used as escape release or emergency unlocking
- › No automatic return
- › Sheath length 3 m (rope length 6 m)



**111233** AE-B-A1-03,0-F-111233

✓ Features

- › Can be used as escape release or emergency unlocking
- › automatic return
- › Sheath length 3 m (rope length 6 m)



**097747** AE-B-A1-02,0-F-097747

✓ Features

- › Can be used as escape release or emergency unlocking
- › automatic return
- › Sheath length 2 m (rope length 6 m)



**096230** AE-B-A1-02,0-096230

✓ Features

- › Can be used as escape release or emergency unlocking
- › No automatic return
- › Sheath length 2 m (rope length 6 m)

## Spare parts

- ✓ Replacement key for mechanical key release



**099434** ERSATZSCHLUESSEL GLEICHSCHL.0354

## Connection material

- ✓ Cable glands M20x1.5





086233 EKPM20/06 086233

## Instructions

### ▼ Istruzioni di impiego Finecorsa di sicurezza STP-TW... (Twin)

	Doc. no.	Version	Language	Download
Betriebsanleitung Sicherheitsschalter STP-TW... (Twin)	2100047	07-01/18		5.9 MB
Operating Instructions Safety Switch STP-TW... (Twin)				
Manual de instrucciones Interruptores de seguridad STP-TW... (Twin)				
Mode d'emploi Interrupteur de sécurité STP-TW... (Twin)				
Istruzioni di impiego Finecorsa di sicurezza STP-TW... (Twin)	2100047	07-01/18		1.5 MB

## Catalogs











### ▼ Bezpečnostní spínače s plastovým pouzdem Sicherheitsschalter mit Kunststoffgehäuse Safety Switches with Plastic Housing Interruptores de seguridad con carcasa plástica Interrupteurs de sécurité avec boîtier plastique 塑料壳体 的安全开关

	Doc. no.	Version	Language	Download
Sicherheitsschalter mit Kunststoffgehäuse	096955	11-03/18		6.6 MB
Interrupteurs de sécurité avec boîtier plastique	100677	11-03/18		6.6 MB
Interruptores de seguridad con carcasa plástica	104855	11-03/18		6.6 MB
Bezpečnostní spínače s plastovým pouzdem	121649	11-03/18		6.6 MB
Safety Switches with Plastic Housing	096956	11-03/18		6.6 MB
塑料壳体 的安全开关	116243	11-03/18		6.2 MB

## Declaration of conformity

### ▼ EU prohlášení o shodě

	Doc. no.	Version	Language	Download
EU-Konformitätserklärung	2077153	25-02/17		0.3 MB
Declaración UE de conformidad				
Déclaration UE de conformité				
Dichiarazione di conformità				
EU declaration of conformity				

EU prohlášení o shodě	2077153	25-02/17		 0.5 MB
EU-overensstemmelseserklæring				
Δήλωση συμμόρφωσης της ΕΕ				
EU-vaatimustenmukaisuusvakuutus				
EU-típusbizonyítvány				
EU-conformiteitsverklaring				
Deklaracja zgodności UE				
Declaração de Conformidade UE				
Declarația de conformitate UE				
EÚ vyhlásenie o zhode			