

ITEM 103910 STP-TW-4A-4131AC024M

Description	Technical data	Accessories	Downloads
-------------	----------------	-------------	-----------



Features

- › Actuating heads made of metal
- › Simultaneous monitoring of two safety doors
- › Auxiliary release on the front
- › With door monitoring contact

Approach direction

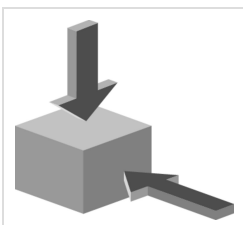

- › Figure
Horizontal and vertical
Can be adjusted in 90° steps

Solenoid operating voltage

- › AC/DC 24 V +10%, -15%

Guard locking type

STP4 Open-circuit current principle, guard locking by applying voltage to the guard locking solenoid. Release by spring force.

Switching element

4131 Slow-action switching contact 2 NC \oplus + 1 NO + 1 NO (door monitoring contact)

Auxiliary release

Is used for releasing the guard locking with the aid of a tool. To protect against tampering, the auxiliary release is sealed with sealing lacquer.

Approvals



Mechanical values and environment

Ambient temperature	-20 ... 55 °C
Mechanical life	1 x 10 ⁶
Number of door position NO contacts	1
Number of guard lock monitoring positively driven contacts	2
Number of guard lock monitoring NO contacts	1
Actuation frequency	1200 1/h
Locking force F _{max}	2500 N
Locking force F _{Zh}	2000 N
Retention force	20 N
Extraction force	30 N
Actuating force	35 N
Insertion depth	min.24,5 mm

Electrical connection ratings

Rated thermal current I _{th}	4 A
Utilization category according to EN 60947-5-1	AC-15 DC-13
Rated insulation voltage U _i	250 V
Rated impulse withstand voltage U _{imp}	2,5 kV
Power consumption	8 W

Solenoid duty cycle	100 %
Connection cross-section	0,34 ... 1,5 mm ²

in combination with Actuator BETAETIGER-S-GT-SN

Mechanical values and environment

Overtravel	5 mm
------------	------

Dimension drawing

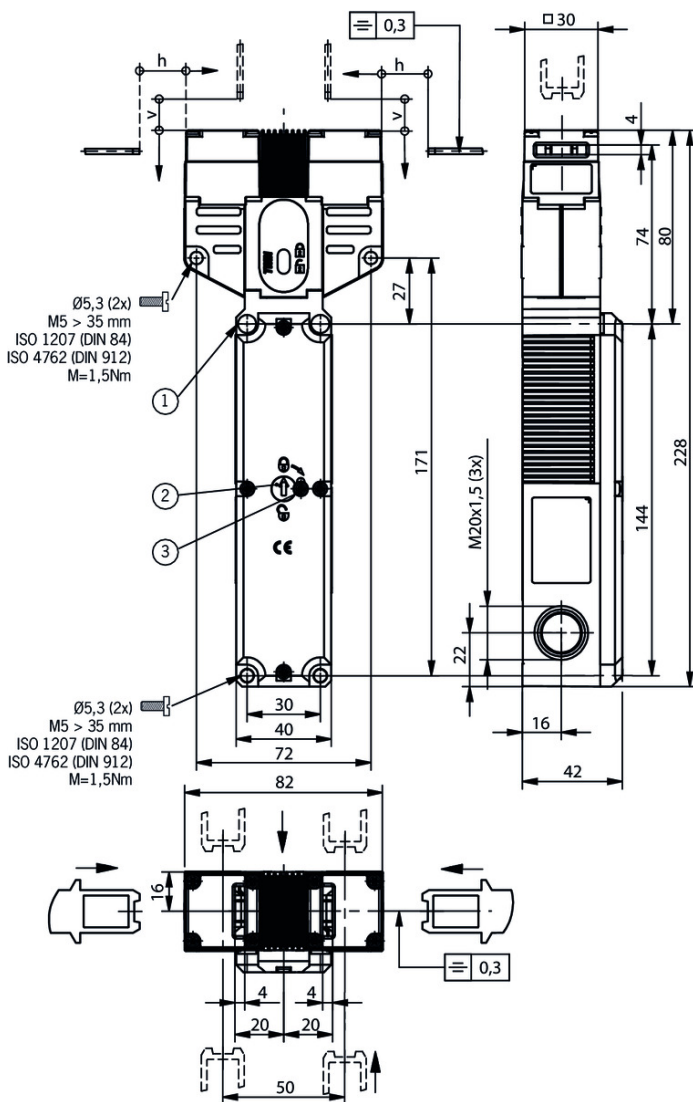

Legende

- 1 Do not screw tight here (2x)
- 2 Auxiliary release
- 3 Locking screw

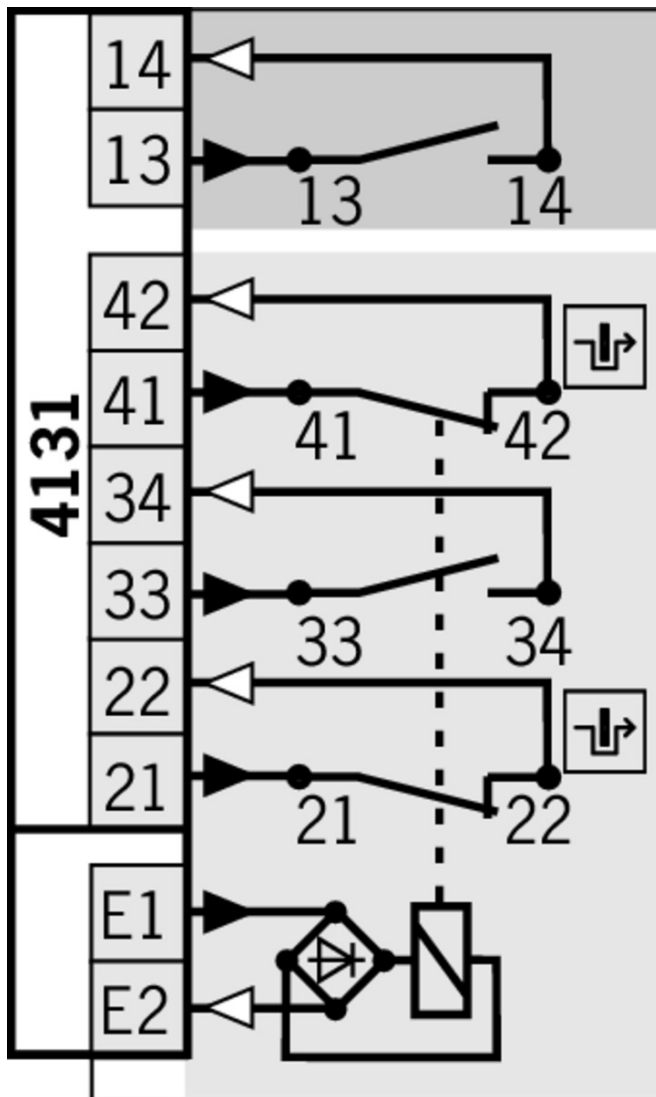

Legende

- Solenoid monitoring
- Door monitoring

Switching functions

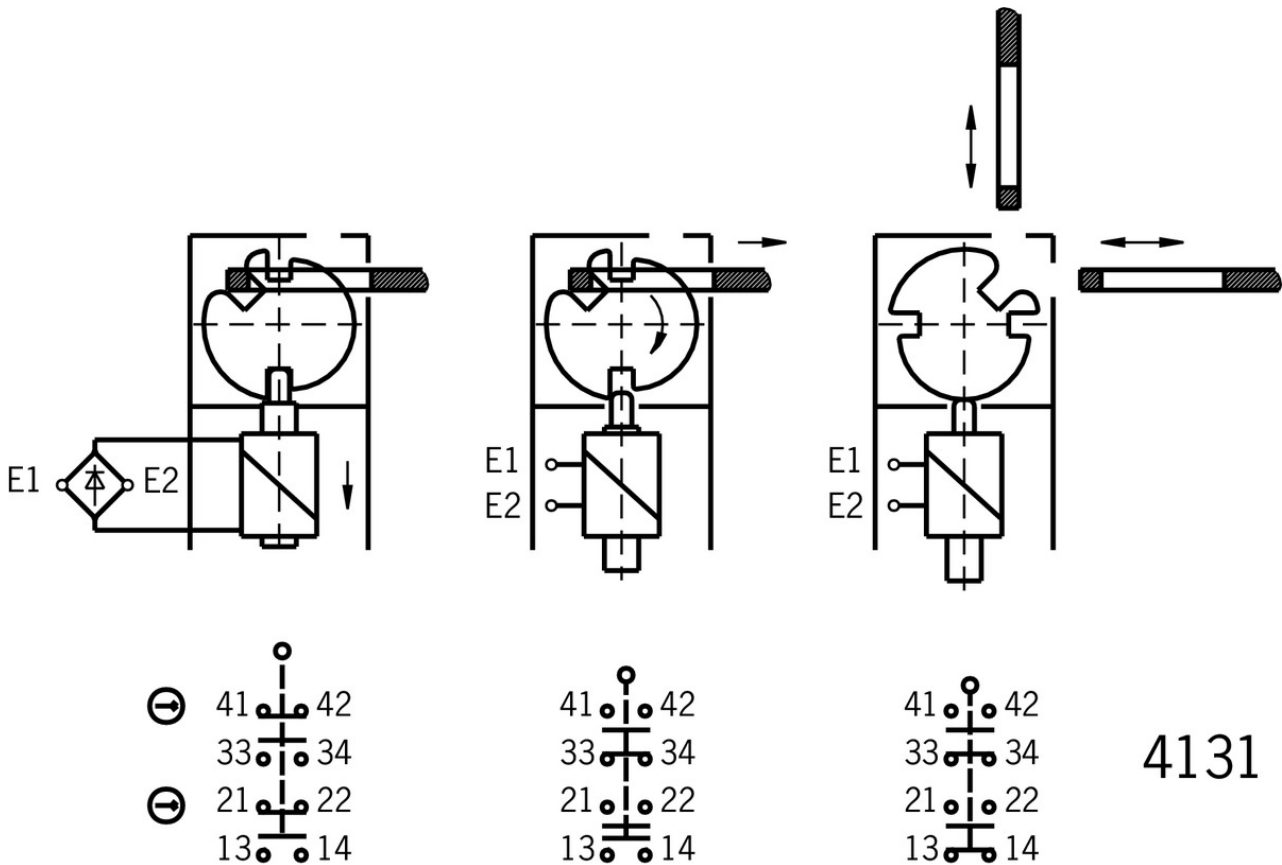

Actuator

Actuator S for safety switches SGA/SGP/STA/STP/STM



097861 BETAETIGER-S-G-SN-C2115

Features

- › Two safety screws included
- › Physically compatible with TP actuator P-G



095738 BETAETIGER-S-GT-SN

Features

- › Two safety screws included
- › Actuators with rubber bushings

Actuator S, bent, for safety switches SGA/SGP/STA/STP/STM



095740 BETAETIGER-S-WQT-SN

Features

- › Two safety screws included



115073 BETAETIGER-S-W-SN-C2115

Features

- › Two stainless safety screws per actuator
- › Minimum door radius 300 mm



105808 BETAETIGER-S-WT-SN-C2115

✓ Features

- › Two stainless safety screws per actuator
- › Actuators with rubber bushings
- › Minimum door radius 300 mm

✓ Hinged actuator S top/bottom for safety switches SGA/SGP/STA/STP/STM



095315 RADIUSBETAETIGER-S-OU-SN

✓ Features

- › Actuators made of stainless steel
- › Two safety screws included
- › For doors hinged at top and bottom

✓ Hinged actuator S left/right for safety switches SGA/SGP/STA/STP/STM



096838 RADIUSBETAETIGER-S-LR-SN

✓ Features

- › Actuators made of stainless steel
- › Two safety screws included
- › For doors hinged on right and left

✓ Actuator L, bent, for safety switches SGA/SGP/STA/STP/STM for insertion funnel



105809 BETAETIGER-S-WT-LN-C2115

✓ Features

- › Two stainless safety screws per actuator
- › Actuators with rubber bushings
- › Minimum door radius 300 mm

Spare parts

✓ Replacement key for mechanical key release



099434 ERSATZSCHLUESSEL GLEICHSCHL.0354

Function expansion

✓ Emergency unlocking for safety switches CTP/TP/STP



099877 NOTENTSPERRUNG TP/STP

✓ Release with automatic reset for safety switches CTP/TP/STP

103110 ENTRIEGELUNG RUECKSTELLEND TP/STP



Handle for wire front release



099795 AY-HDL-099795

Features

- › Suitable for all wire front releases



Lockout bar STA/STP/SGA/SGP/STM



105701 SPERREINSATZ STP/STA

Features

- › Prevents unintentional closing of the door
- › Can be secured with padlocks



Lock for auxiliary release for safety switches CTP/TP/STP



109212 SCHLOSS TP GLEICHSCHLIESSEND C2293

Features

- › Identical locking
- › Key can be removed only in “locked” position



084177 SCHLOSS TP VERSCHIEDENSCHLIESSEND

Features

- › Lock unique locking
- › Key removable in “unlocked” and “locked” positions



086236 SCHLOSS TP GLEICHSCHLIESSEND

Features

- › Identical locking
- › Key removable in “unlocked” and “locked” positions



LED set



098035 STP LED SET



Built-in LED



087423 EINBAULEUCHTE LED M20X1,5



095510 EINBAULEUCHTE LED-F M20X1,5



Handle for escape release for safety switches TP/STP/STA



105329 FE-GRIFF

▼ Wire front release



096230 AE-B-A1-02,0-096230

▼ Features

- › Can be used as escape release or emergency unlocking
- › No automatic return
- › Sheath length 2 m (rope length 6 m)



097747 AE-B-A1-02,0-F-097747

▼ Features

- › Can be used as escape release or emergency unlocking
- › automatic return
- › Sheath length 2 m (rope length 6 m)



098313 AE-B-A1-03,0-098313

▼ Features

- › Can be used as escape release or emergency unlocking
- › No automatic return
- › Sheath length 3 m (rope length 6 m)



111233 AE-B-A1-03,0-F-111233

▼ Features

- › Can be used as escape release or emergency unlocking
- › automatic return
- › Sheath length 3 m (rope length 6 m)



098314 AE-B-A1-04,0-098314

▼ Features

- › Can be used as escape release or emergency unlocking
- › No automatic return
- › Sheath length 4 m (rope length 6 m)



124770 AE-B-A1-06,0-F-124770

▼ Features

- › Can be used as escape release or emergency unlocking
- › automatic return
- › Rope length 6 m (without sheath)



125582 AE-B-A1-06,0-125582

▼ Features

- › Can be used as escape release or emergency unlocking
- › No automatic return
- › Rope length 6 m (without sheath)

Connection material

▼ Cable glands M20x1.5

086233 EKPM20/06 086233



Instructions

▼ Istruzioni di impiego Finecorsa di sicurezza STP-TW... (Twin)

	Doc. no.	Version	Language	Download
Betriebsanleitung Sicherheitsschalter STP-TW... (Twin)	2100047	07-01/18		5.9 MB
Operating Instructions Safety Switch STP-TW... (Twin)				
Manual de instrucciones Interruptores de seguridad STP-TW... (Twin)				
Mode d'emploi Interrupteur de sécurité STP-TW... (Twin)				
Istruzioni di impiego Finecorsa di sicurezza STP-TW... (Twin)	2100047	07-01/18		1.5 MB

Catalogs











▼ Bezpečnostní spínače s plastovým pouzdrém Sicherheitsschalter mit Kunststoffgehäuse Safety Switches with Plastic Housing Interruptores de seguridad con carcasa plástica Interrupteurs de sécurité avec boîtier plastique 塑料壳体 的安全开关

	Doc. no.	Version	Language	Download
Sicherheitsschalter mit Kunststoffgehäuse	096955	11-03/18		6.6 MB
Interrupteurs de sécurité avec boîtier plastique	100677	11-03/18		6.6 MB
Interruptores de seguridad con carcasa plástica	104855	11-03/18		6.6 MB
Bezpečnostní spínače s plastovým pouzdrém	121649	11-03/18		6.6 MB
Safety Switches with Plastic Housing	096956	11-03/18		6.6 MB
塑料壳体 的安全开关	116243	11-03/18		6.2 MB

Declaration of conformity

▼ EU prohlášení o shodě

	Doc. no.	Version	Language	Download
EU-Konformitätserklärung	2077153	25-02/17		0.3 MB
Declaración UE de conformidad				
Déclaration UE de conformité				
Dichiarazione di conformità				
EU declaration of conformity				

EU prohlášení o shodě	2077153	25-02/17		 0.5 MB
EU-overensstemmelseserklæring				
Δήλωση συμμόρφωσης της ΕΕ				
EU-vaatimustenmukaisuusvakuutus				
EU-típusbizonyítvány				
EU-conformiteitsverklaring				
Deklaracja zgodności UE				
Declaração de Conformidade UE				
Declarația de conformitate UE				
EÚ vyhlásenie o zhode			