

ITEM 084261 TP3-4121K110M

Description	Technical data	Accessories	Downloads
-------------	----------------	-------------	-----------



Features

- › Auxiliary release on the front
- › With door monitoring contact
- › Increased overtravel for horizontal and vertical approach direction.

Approach direction



› Figure

Horizontal and vertical

Can be adjusted in 90° steps

Increased overtravel for horizontal and vertical approach direction.

Solenoid operating voltage

- › AC 110 V +10%, -15%

Guard locking type

TP3 Closed-circuit current principle, guard locking by spring force. Release by applying voltage to the guard locking solenoid.

Switching element

4121 Slow-action switching contact 2 NC \oplus + 1 NC / 1 NO (door monitoring contact)

Auxiliary release

Is used for releasing the guard locking with the aid of a tool. To protect against tampering, the auxiliary release is sealed with sealing lacquer.

Approvals



Mechanical values and environment

Ambient temperature	-20 ... 55 °C
Mechanical life	1 x 10 ⁶
Number of door position positively driven contacts	2
Number of NC contacts	1
Number of NO contacts	1
Actuation frequency	1200 1/h
Locking force F _{max}	1300 N
Locking force F _{Zh}	1000 N
Retention force	10 N
Extraction force	20 N
Actuating force	10 N

Electrical connection ratings

Rated thermal current I _{th}	4 A
Utilization category according to EN 60947-5-1	AC-15 DC-13
Rated insulation voltage U _i	250 V
Rated impulse withstand voltage U _{imp}	2,5 kV
Power consumption	10 W
Solenoid duty cycle	100 %
Connection cross-section	0,34 ... 1,5 mm ²

in combination with Actuator BETAETIGER-P-GT

Mechanical values and environment

Overtravel A B C D E	2 mm
Overtravel K L M N	1,5 mm

in combination with Actuator BETAETIGER-P-GNT

Mechanical values and environment

Overtravel A B C D E	7 mm
Overtravel K L M N	7 mm

Dimension drawing

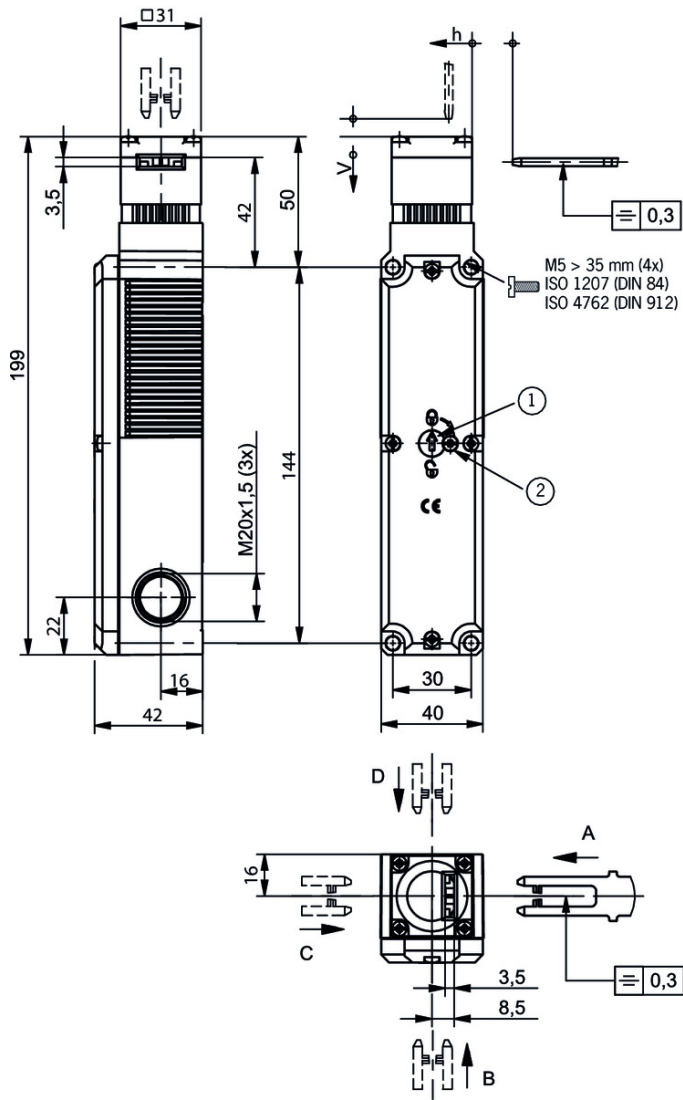

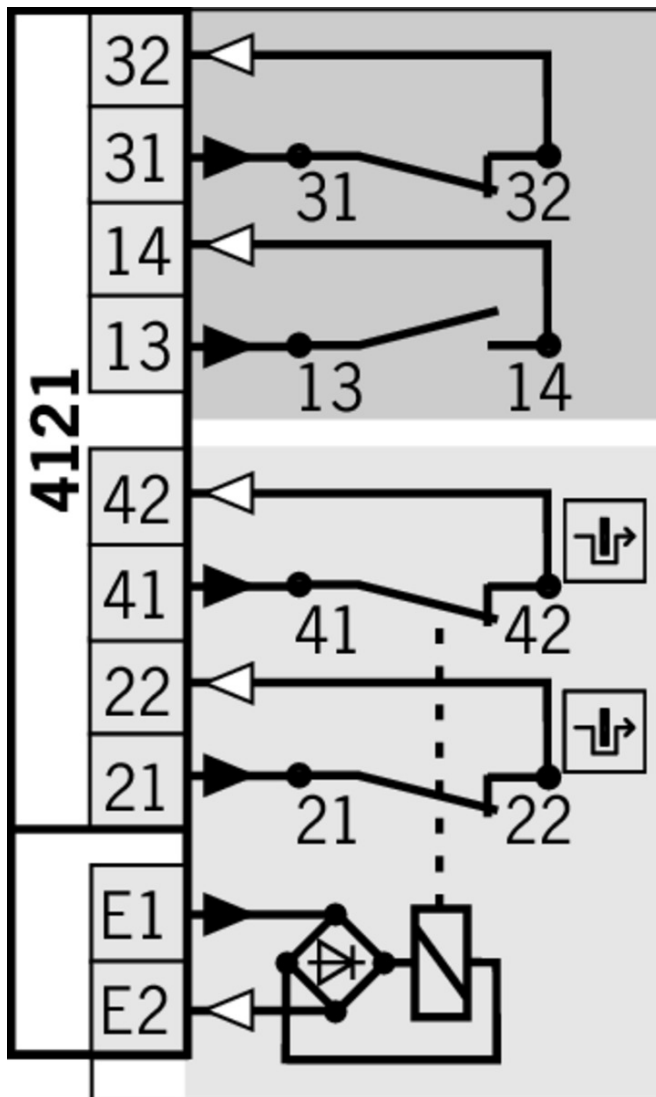

Legende

- 1 Auxiliary release
- 2 Locking screw



Legende

-  Solenoid monitoring
-  Door monitoring

Switching functions

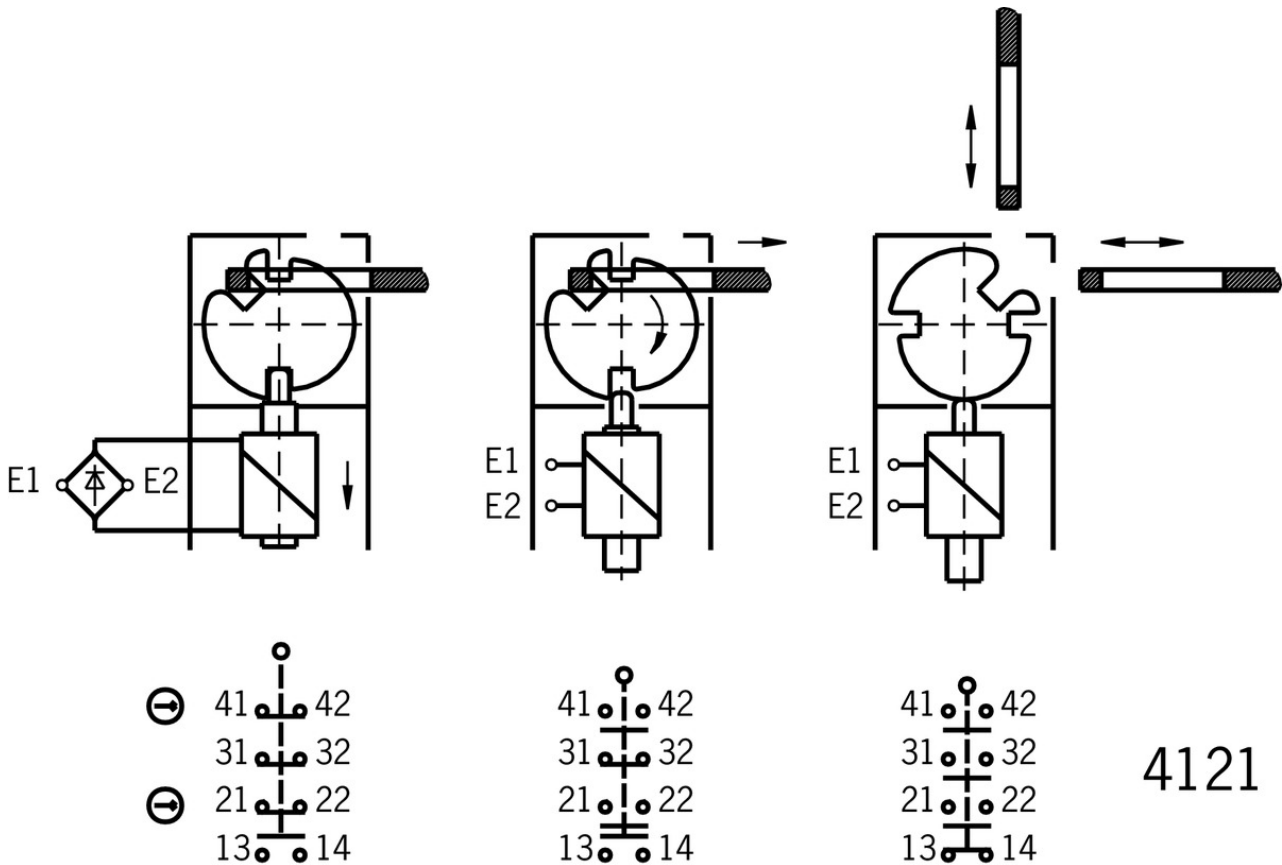

Function expansion

Wire front release



098313 AE-B-A1-03,0-098313

Features

- › Can be used as escape release or emergency unlocking
- › No automatic return
- › Sheath length 3 m (rope length 6 m)



098314 AE-B-A1-04,0-098314

Features

- › Can be used as escape release or emergency unlocking
- › No automatic return
- › Sheath length 4 m (rope length 6 m)



096230 AE-B-A1-02,0-096230

Features

- › Can be used as escape release or emergency unlocking
- › No automatic return
- › Sheath length 2 m (rope length 6 m)



097747 AE-B-A1-02,0-F-097747

Features

- › Can be used as escape release or emergency unlocking

- › automatic return
- › Sheath length 2 m (rope length 6 m)



124770 AE-B-A1-06,0-F-124770

✓ Features

- › Can be used as escape release or emergency unlocking
- › automatic return
- › Rope length 6 m (without sheath)



111233 AE-B-A1-03,0-F-111233

✓ Features

- › Can be used as escape release or emergency unlocking
- › automatic return
- › Sheath length 3 m (rope length 6 m)



125582 AE-B-A1-06,0-125582

✓ Features

- › Can be used as escape release or emergency unlocking
- › No automatic return
- › Rope length 6 m (without sheath)

✓ Lock for auxiliary release for safety switches CTP/TP/STP



109212 SCHLOSS TP GLEICHSCHLIESSEND C2293

✓ Features

- › Identical locking
- › Key can be removed only in “locked” position



086236 SCHLOSS TP GLEICHSCHLIESSEND

✓ Features

- › Identical locking
- › Key removable in “unlocked” and “locked” positions



084177 SCHLOSS TP VERSCHIEDENSCHLIESSEND

✓ Features

- › Lock unique locking
- › Key removable in “unlocked” and “locked” positions

✓ LED set



093752 TP LED SET

✓ Features

- › LED set

✓ Latch spring for increased retention force

076501 RASTFEDER NP/TP

▼ Built-in LED



095510 EINBAULEUCHTE LED-F M20X1,5



087423 EINBAULEUCHTE LED M20X1,5

▼ Lockout bar NP/GP/TP



096105 SPERREINSATZ TP

▼ Features

- › Prevents unintentional closing of the door
- › Can be secured with padlocks

▼ Emergency unlocking for safety switches CTP/TP/STP



099877 NOTENTSPERRUNG TP/STP

▼ Release with automatic reset for safety switches CTP/TP/STP



103110 ENTRIEGELUNG RUECKSTELLEND TP/STP

▼ Handle for wire front release



099795 AY-HDL-099795

▼ Features

- › Suitable for all wire front releases

▼ Insertion funnel for safety switches NP..A/GP/TP..A



086237 EINFUEHRTRICHTER-P

▼ Handle for escape release for safety switches TP/STP/STA



105329 FE-GRIFF

Actuator

▼ Bent actuator for safety switches NP/GP/TP



070038 BETAETIGER-P-WT

▼ Features

- › Actuators made of stainless steel
- › Two stainless safety screws per actuator

- › Actuators with rubber bushings



059227 BETAETIGER-P-W

✓ Features

- › Actuators made of stainless steel
- › Two stainless safety screws per actuator

- ✓ Hinged actuator left/right for safety switches NP/GP/TP, increased overtravel



074573 RADIUSBETAETIGER-P-LRN

✓ Features

- › Actuators made of stainless steel
- › Two stainless safety screws per actuator
- › For doors hinged on right and left

- ✓ Bent actuator for safety switches NP/GP/TP, increased overtravel



074577 BETAETIGER-P-WNT

✓ Features

- › Actuators made of stainless steel
- › Two stainless safety screws per actuator
- › Actuators with rubber bushings



074571 BETAETIGER-P-WN

✓ Features

- › Actuators made of stainless steel
- › Two stainless safety screws per actuator

- ✓ Hinged actuator left/right for safety switches NP/GP/TP



059440 RADIUSBETAETIGER-P-LR

✓ Features

- › Actuators made of stainless steel
- › Two stainless safety screws per actuator
- › For doors hinged on right and left

- ✓ Actuators for safety switches NP/GP/TP, increased overtravel



074576 BETAETIGER-P-GNT

✓ Features

- › Actuators made of stainless steel
- › Two stainless safety screws per actuator
- › Actuators with rubber bushings



074570 BETAETIGER-P-GN

✓ Features

- › Actuators made of stainless steel
- › Two stainless safety screws per actuator

- ▼ Hinged actuator top/bottom for safety switches NP/GP/TP



070050 RADIUSBETAETIGER-P-OU

▼ Features

- › Actuators made of stainless steel
- › Two stainless safety screws per actuator
- › For doors hinged at top and bottom

- ▼ Hinged actuator top/bottom for safety switches NP/GP/TP, increased overtravel



074572 RADIUSBETAETIGER-P-OUN

▼ Features

- › Actuators made of stainless steel
- › Two stainless safety screws per actuator
- › For doors hinged at top and bottom

- ▼ Actuators for safety switches NP/GP/TP



059226 BETAETIGER-P-G

▼ Features

- › Actuators made of stainless steel
- › Two stainless safety screws per actuator



070046 BETAETIGER-P-GT

▼ Features

- › Actuators made of stainless steel
- › Two stainless safety screws per actuator
- › Actuators with rubber bushings

Mounting accessories

- ▼ Mounting plates EMP-SB for safety switches CTP, TP...A, STA, STP and TX



093456 EMP-SB

▼ Features

- › For vertical and horizontal mounting of safety switches TP...A, STA, STP and TX

- ▼ Mounting plates EMP-B1 for actuators for safety switches CTP, TP...A, STA, STP, TX and TZ



093457 EMP-B1

- ▼ Mounting plates EMP-B2 for actuators for safety switches CTP, TP...A, STA, STP, TX and TZ



093458 EMP-B2

- ▼ Safety screws M5 x 25

073457 M5X25/V100

▼ Features

- › Safety screws M5 x 25
 - › Packaging unit 100 pieces
-

▼ Safety screws for actuators, M5 x 10

073455 M5X10-NIRO/V100 NZ/TZ

▼ Features

- › Safety screws M5 x 10
 - › Packaging unit 100 pieces
-

▼ Safety screws for safety switches M4 x 14, large head

086232 M4X14-NIRO/V100

▼ Features

- › Safety screws M4 x 14 (large head)
 - › Packaging unit 100 pieces
-

▼ Switch bracket for bolt NP/TP



073539 SCHALTERAUFNAHME TP

▼ Features

- › Switch bracket made of steel
 - › For doors hinged on the left or right
-

▼ Switch bracket TP/STP GFK



096613 SCHALTERAUFNAHME TP/STP GFK

▼ Features

- › Switch bracket made of fiber glass reinforced plastic
 - › For left or right hinged doors
-

Connection material













▼ Cable glands M20x1.5



086233 EKPM20/06 086233













Instructions

▼ Návod k použití Bezpečnostní spínač TP...

Betriebsanleitung Sicherheitsschalter TP... Manual de instrucciones Interruptores de seguridad TP... Mode d'emploi pour les interrupteurs de sécurité TP... Operating Instructions Safety Switches TP...	2084123	15-12/17	   	 5.7 MB
Návod k použití Bezpečnostní spínač TP...	2084123	15-12/17		 1.5 MB
Driftsvejledning for sikkerhedsafbryder TP...	2084123	15-12/17		 1.5 MB
Manual de instruções Chave de segurança TP...	2084123	15-12/17		 1.5 MB
Istruzioni di impiego dei finecorsa di sicurezza TP...	2084123	15-12/17		 1.5 MB

Catalogs

- Bezpečnostní spínače s plastovým pouzdem Sicherheitsschalter mit Kunststoffgehäuse Safety Switches with Plastic Housing Interruptores de seguridad con carcasa plástica Interrupteurs de sécurité avec boîtier plastique 塑料壳体 的安全开关

	Doc. no.	Version	Language	Download
Sicherheitsschalter mit Kunststoffgehäuse	096955	11-03/18		 6.6 MB
Interrupteurs de sécurité avec boîtier plastique	100677	11-03/18		 6.6 MB
Interruptores de seguridad con carcasa plástica	104855	11-03/18		 6.6 MB
Bezpečnostní spínače s plastovým pouzdem	121649	11-03/18		 6.6 MB
Safety Switches with Plastic Housing	096956	11-03/18		 6.6 MB
塑料壳体 的安全开关	116243	11-03/18		 6.2 MB

Declaration of conformity

- EU prohlášení o shodě

	Doc. no.	Version	Language	Download
EU-Konformitätserklärung Declaración UE de conformidad Déclaration UE de conformité Dichiarazione di conformità EU declaration of conformity	2077153	25-02/17	    	 0.3 MB
EU prohlášení o shodě EU-overensstemmelseserklæring Δήλωση συμμόρφωσης της ΕΕ EU-vaatimustenmukaisuusvakuutus EU-típusbizonyítvány EU-conformiteitsverklaring Deklaracja zgodności UE Declaração de Conformidade UE Declarația de conformitate UE EÚ vyhlásenie o zhode	2077153	25-02/17	         	 0.5 MB

CAD data

CAD data for this item on TraceParts