

ITEM 084330 TP2-528A110M

Description	Technical data	Accessories	Downloads
-------------	----------------	-------------	-----------



Features

- › Auxiliary release on the front
- › Without door monitoring contact
- › Increased horizontal overtravel

Approach direction



- › Figure
Horizontal and vertical
Can be adjusted in 90° steps
Increased overtravel for horizontal approach direction

Solenoid operating voltage

- › AC 110 V +10%, -15%

Guard locking type

TP2 Open-circuit current principle, guard locking by applying voltage to the guard locking solenoid. Release by spring force.

Switching element

528 Slow-action switching contact 1 NC \ominus + 1 NO

Auxiliary release

Is used for releasing the guard locking with the aid of a tool. To protect against tampering, the auxiliary release is sealed with sealing lacquer.

Approvals



Mechanical values and environment

Ambient temperature	-20 ... 55 °C
Mechanical life	1×10^6
Number of door position positively driven contacts	1
Number of NO contacts	1
Actuation frequency	1200 1/h
Locking force F_{max}	1300 N
Locking force F_{Zh}	1000 N
Retention force	10 N
Extraction force	20 N
Actuating force	10 N

Electrical connection ratings

Rated thermal current I_{th}	4 A
Utilization category according to EN 60947-5-1	AC-15 DC-13
Rated insulation voltage U_i	250 V
Rated impulse withstand voltage U_{imp}	2,5 kV
Power consumption	10 W
Solenoid duty cycle	100 %
Connection cross-section	0,34 ... 1,5 mm ²

in combination with Actuator BETAETIGER-P-GT

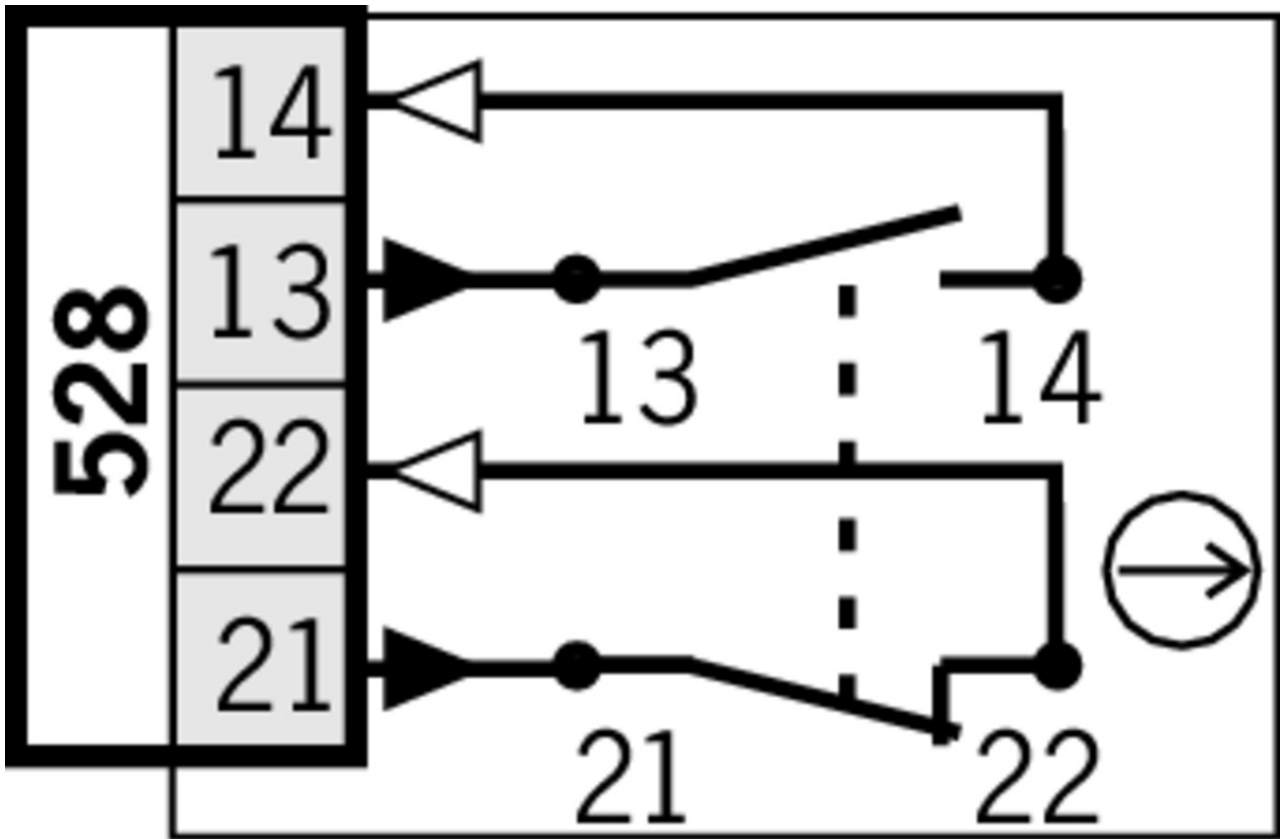

Switching functions

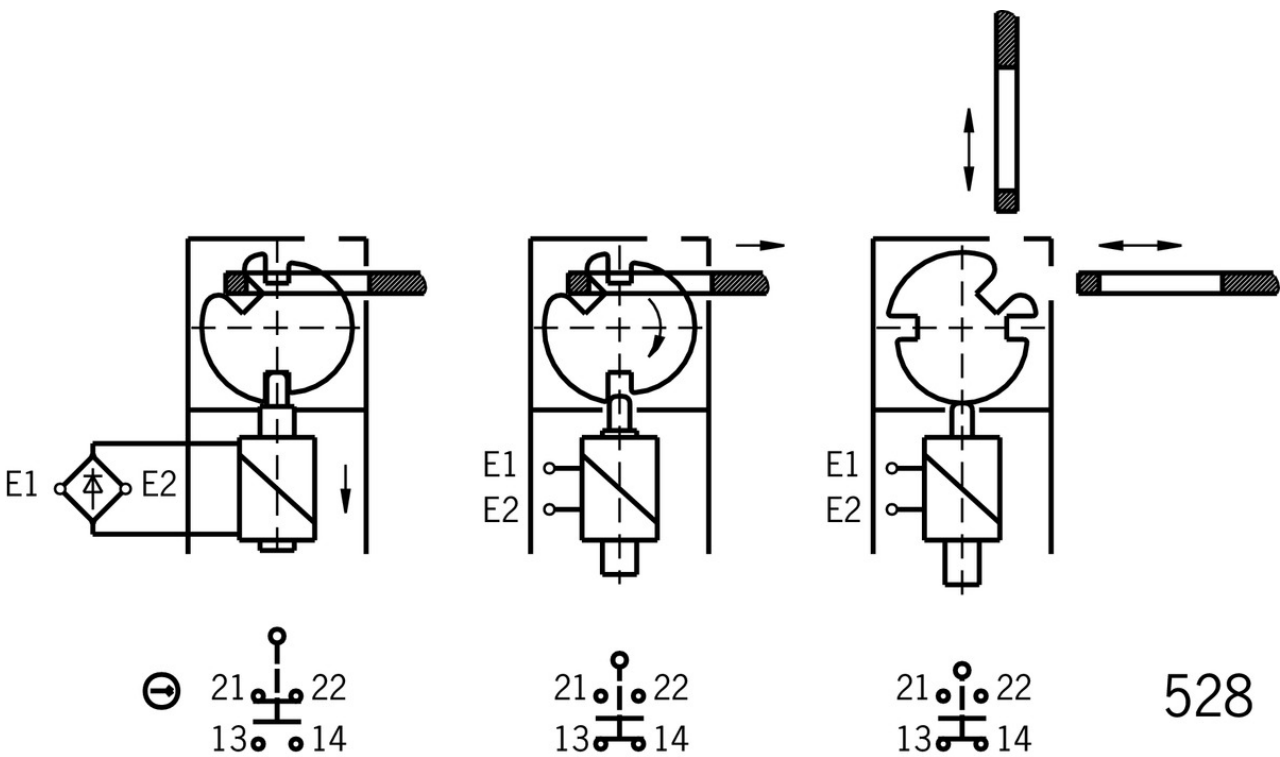

Actuator

▼ Actuators for safety switches NP/GP/TP



059226 BETAETIGER-P-G

▼ Features

- › Actuators made of stainless steel
- › Two stainless safety screws per actuator



070046 BETAETIGER-P-GT

▼ Features

- › Actuators made of stainless steel
- › Two stainless safety screws per actuator
- › Actuators with rubber bushings

▼ Bent actuator for safety switches NP/GP/TP



059227 BETAETIGER-P-W

▼ Features

- › Actuators made of stainless steel
- › Two stainless safety screws per actuator



070038 BETAETIGER-P-WT

▼ Features

- › Actuators made of stainless steel
- › Two stainless safety screws per actuator
- › Actuators with rubber bushings

▼ Actuators for safety switches NP/GP/TP, increased overtravel



074570 BETAETIGER-P-GN

▼ Features

- › Actuators made of stainless steel
- › Two stainless safety screws per actuator



074576 BETAETIGER-P-GNT

▼ Features

- › Actuators made of stainless steel
- › Two stainless safety screws per actuator
- › Actuators with rubber bushings

▼ Bent actuator for safety switches NP/GP/TP, increased overtravel



074571 BETAETIGER-P-WN

▼ Features

- › Actuators made of stainless steel
- › Two stainless safety screws per actuator



074577 BETAETIGER-P-WNT

▼ Features

- › Actuators made of stainless steel
- › Two stainless safety screws per actuator

- › Actuators with rubber bushings
-

- ▼ Hinged actuator top/bottom for safety switches NP/GP/TP



070050 RADIUSBETAETIGER-P-OU

▼ Features

- › Actuators made of stainless steel
 - › Two stainless safety screws per actuator
 - › For doors hinged at top and bottom
-

- ▼ Hinged actuator left/right for safety switches NP/GP/TP



059440 RADIUSBETAETIGER-P-LR

▼ Features

- › Actuators made of stainless steel
 - › Two stainless safety screws per actuator
 - › For doors hinged on right and left
-

- ▼ Hinged actuator left/right for safety switches NP/GP/TP, increased overtravel



074573 RADIUSBETAETIGER-P-LRN

▼ Features

- › Actuators made of stainless steel
 - › Two stainless safety screws per actuator
 - › For doors hinged on right and left
-

- ▼ Hinged actuator top/bottom for safety switches NP/GP/TP, increased overtravel



074572 RADIUSBETAETIGER-P-OUN

▼ Features

- › Actuators made of stainless steel
 - › Two stainless safety screws per actuator
 - › For doors hinged at top and bottom
-

Bolt

- ▼ Bolt 0 NP/TP for safety switches NP, GP and TP



073535 RIEGEL 0 NP/TP OHNE RASTUNG

▼ Features

- › Steel bolt
 - › For doors hinged on the left or right
 - › Can be locked in open position with padlocks
 - › Actuator included
-

- ▼ Bolt TP/GP... for safety switches GP and TP



084430 RIEGEL TP-A

▼ Features

- › Steel bolt
- › For doors hinged on the right
- › Can be locked in open position with padlocks
- › Actuator included



084432 RIEGEL TP-C

✓ Features

- › Steel bolt
- › For doors hinged on the left
- › Can be locked in open position with padlocks
- › Actuator included

✓ Bolt 1 NP/TP for safety switches NP, GP and TP



073536 RIEGEL 1 NP/TP 1X RASTUNG ZU

✓ Features

- › Steel bolt
- › For doors hinged on the left or right
- › Can be locked in open position with padlocks
- › Actuator included
- › Detent mechanism closed position

✓ Bolt TP-GFK for safety switches TP and GP



096616 RIEGEL TP-GFK

✓ Features

- › Fiber glass reinforced plastic bolt
- › For doors hinged on the left or right
- › Can be locked in open position with padlocks
- › Actuator included

✓ Bolt BTC-T/GP... without escape release for safety switches GP and TP



106301 BTC-T/GP-S-TH-00-X

✓ Features

- › Aluminum bolt
- › For doors hinged on the left or right
- › Can be locked in open position with padlocks
- › Actuator included

Function expansion

✓ Insertion funnel for safety switches NP..A/GP/TP..A



086237 EINFUEHRTRICHTER-P

✓ Built-in LED

087423 EINBAULEUCHTE LED M20X1,5



095510 EINBAULEUCHTE LED-F M20X1,5

▼ LED set

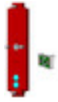

093752 TP LED SET

- ▼ Features
 - › LED set

▼ Lock for auxiliary release for safety switches CTP/TP/STP



086236 SCHLOSS TP GLEICHSCHLIESSEND

- ▼ Features
 - › Identical locking
 - › Key removable in “unlocked” and “locked” positions



084177 SCHLOSS TP VERSCHIEDENSCHLIESSEND

- ▼ Features
 - › Lock unique locking
 - › Key removable in “unlocked” and “locked” positions



109212 SCHLOSS TP GLEICHSCHLIESSEND C2293

- ▼ Features
 - › Identical locking
 - › Key can be removed only in “locked” position

▼ Emergency unlocking for safety switches CTP/TP/STP



099877 NOTENTSPERRUNG TP/STP

▼ Release with automatic reset for safety switches CTP/TP/STP



103110 ENTRIEGELUNG RUECKSTELLEND TP/STP

▼ Lockout bar NP/GP/TP



096105 SPERREINSATZ TP

- ▼ Features
 - › Prevents unintentional closing of the door
 - › Can be secured with padlocks

▼ Wire front release

098313 AE-B-A1-03,0-098313

- ▼ Features



- › Can be used as escape release or emergency unlocking
- › No automatic return
- › Sheath length 3 m (rope length 6 m)



096230 AE-B-A1-02,0-096230

✓ Features

- › Can be used as escape release or emergency unlocking
- › No automatic return
- › Sheath length 2 m (rope length 6 m)



098314 AE-B-A1-04,0-098314

✓ Features

- › Can be used as escape release or emergency unlocking
- › No automatic return
- › Sheath length 4 m (rope length 6 m)



097747 AE-B-A1-02,0-F-097747

✓ Features

- › Can be used as escape release or emergency unlocking
- › automatic return
- › Sheath length 2 m (rope length 6 m)



111233 AE-B-A1-03,0-F-111233

✓ Features

- › Can be used as escape release or emergency unlocking
- › automatic return
- › Sheath length 3 m (rope length 6 m)



125582 AE-B-A1-06,0-125582

✓ Features

- › Can be used as escape release or emergency unlocking
- › No automatic return
- › Rope length 6 m (without sheath)



124770 AE-B-A1-06,0-F-124770

✓ Features

- › Can be used as escape release or emergency unlocking
- › automatic return
- › Rope length 6 m (without sheath)

- ✓ Latch spring for increased retention force

076501 RASTFEDER NP/TP

- ✓ Handle for wire front release



099795 AY-HDL-099795

✓ Features

- › Suitable for all wire front releases

-
- ▼ Handle for escape release for safety switches TP/STP/STA



105329 FE-GRIFF

Mounting accessories

-
- ▼ Mounting plates EMP-B2 for actuators for safety switches CTP, TP...A, STA, STP, TX and TZ



093458 EMP-B2

- ▼ Mounting plates EMP-B1 for actuators for safety switches CTP, TP...A, STA, STP, TX and TZ



093457 EMP-B1

- ▼ Mounting plates EMP-SB for safety switches CTP, TP...A, STA, STP and TX



093456 EMP-SB

- ▼ Features

- › For vertical and horizontal mounting of safety switches TP...A, STA, STP and TX
-

- ▼ Safety screws M5 x 25

073457 M5X25/V100

- ▼ Features

- › Safety screws M5 x 25
 - › Packaging unit 100 pieces
-

- ▼ Safety screws for actuators, M5 x 10

073455 M5X10-NIRO/V100 NZ/TZ

- ▼ Features

- › Safety screws M5 x 10
 - › Packaging unit 100 pieces
-

- ▼ Safety screws for safety switches M4 x 14, large head

086232 M4X14-NIRO/V100

- ▼ Features

- › Safety screws M4 x 14 (large head)
 - › Packaging unit 100 pieces
-

- ▼ Switch bracket for bolt NP/TP



073539 SCHALTERAUFNAHME TP

Features

- › Switch bracket made of steel
- › For doors hinged on the left or right

Switch bracket TP/STP GFK



096613 SCHALTERAUFNAHME TP/STP GFK

Features

- › Switch bracket made of fiber glass reinforced plastic
- › For left or right hinged doors

Connection material

Cable glands M20x1.5



086233 EKPM20/06 086233

Instructions

Návod k použití Bezpečnostní spínač TP...

	Doc. no.	Version	Language	Download
Betriebsanleitung Sicherheitsschalter TP...	2084123	15-12/17		5.7 MB
Manual de instrucciones Interruptores de seguridad TP...				
Mode d'emploi pour les interrupteurs de sécurité TP...				
Operating Instructions Safety Switches TP...				
Návod k použití Bezpečnostní spínač TP...	2084123	15-12/17		1.5 MB
Driftsvejledning for sikkerhedsafbryder TP...	2084123	15-12/17		1.5 MB
Manual de instruções Chave de segurança TP...	2084123	15-12/17		1.5 MB
Istruzioni di impiego dei finecorsa di sicurezza TP...	2084123	15-12/17		1.5 MB

Catalogs

















Bezpečnostní spínače s plastovým pouzdem Sicherheitsschalter mit Kunststoffgehäuse Safety Switches with Plastic Housing Interruptores de seguridad con carcasa plástica Interrupteurs de sécurité avec boîtier plastique 塑料壳体 的安全开关

	Doc. no.	Version	Language	Download
Sicherheitsschalter mit Kunststoffgehäuse	096955	11-03/18		6.6 MB
Interrupteurs de sécurité avec boîtier plastique	100677	11-03/18		6.6 MB

Interruptores de seguridad con carcasa plástica	104855	11-03/18		 6.6 MB
Bezpečnostní spínače s plastovým pouzdrém	121649	11-03/18		 6.6 MB
Safety Switches with Plastic Housing	096956	11-03/18		 6.6 MB
塑料壳体 的安全开关	116243	11-03/18		 6.2 MB

Declaration of conformity

EU prohlášení o shodě

	Doc. no.	Version	Language	Download
EU-Konformitätserklärung Declaración UE de conformidad Déclaration UE de conformité Dichiarazione di conformità EU declaration of conformity	2077153	25-02/17	    	 0.3 MB
EU prohlášení o shodě EU-overensstemmelseserklæring Δήλωση συμμόρφωσης της ΕΕ EU-vaatimustenmukaisuusvakuutus EU-típusbizonyítvány EU-conformiteitsverklaring Deklaracja zgodności UE Declaração de Conformidade UE Declarația de conformitate UE EÚ vyhlásenie o zhode	2077153	25-02/17	         	 0.5 MB

CAD data

CAD data for this item on TraceParts