

ITEM 087378 TP4-4141A024SM8C1992

| Description | Technical data | Accessories | Downloads |
|-------------|----------------|-------------|-----------|
|-------------|----------------|-------------|-----------|



Features

- › Auxiliary release on the front
- › With door monitoring contact
- › Increased horizontal overtravel
- › Plug connector

Approach direction

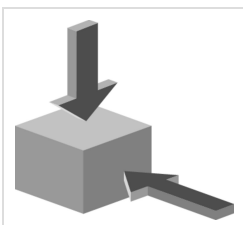

› **Figure**

Horizontal and vertical

Can be adjusted in 90° steps

Increased overtravel for horizontal and vertical approach direction.

Solenoid operating voltage

- › AC/DC 24 V +10%, -15%

Guard locking type

TP4 Open-circuit current principle, guard locking by applying voltage to the guard locking solenoid. Release by spring force.

Switching element

4141 Slow-action switching contact 2 NC ⊕ + 2 NC ⊕ (door monitoring contact)

C1992

Direct connection to a safe bus module

Auxiliary release

Is used for releasing the guard locking with the aid of a tool. To protect against tampering, the auxiliary release is sealed with sealing lacquer.

Approvals



Mechanical values and environment

| | |
|--|---------------------|
| Ambient temperature | -20 ... 55 °C |
| Mechanical life | 1 x 10 ⁶ |
| Number of door position positively driven contacts | 4 |
| Actuation frequency | 1200 1/h |
| Locking force F _{max} | 1300 N |
| Locking force F _{Zh} | 1000 N |
| Retention force | 10 N |
| Extraction force | 20 N |
| Actuating force | 10 N |

Electrical connection ratings

| | |
|--|----------------|
| Rated thermal current I _{th} | 1 A |
| Utilization category according to EN 60947-5-1 | AC-15 DC-13 |
| Rated insulation voltage U _i | 30 V |
| Rated impulse withstand voltage U _{imp} | 1,5 kV |

| | |
|---------------------|-------|
| Power consumption | 8 W |
| Solenoid duty cycle | 100 % |

in combination with Actuator BETAETIGER-P-GT

Mechanical values and environment

| | |
|----------------------|--------|
| Overtravel A B C D E | 2 mm |
| Overtravel K L M N | 1,5 mm |

in combination with Actuator BETAETIGER-P-GNT

Mechanical values and environment

| | |
|----------------------|------|
| Overtravel A B C D E | 7 mm |
|----------------------|------|

Dimension drawing

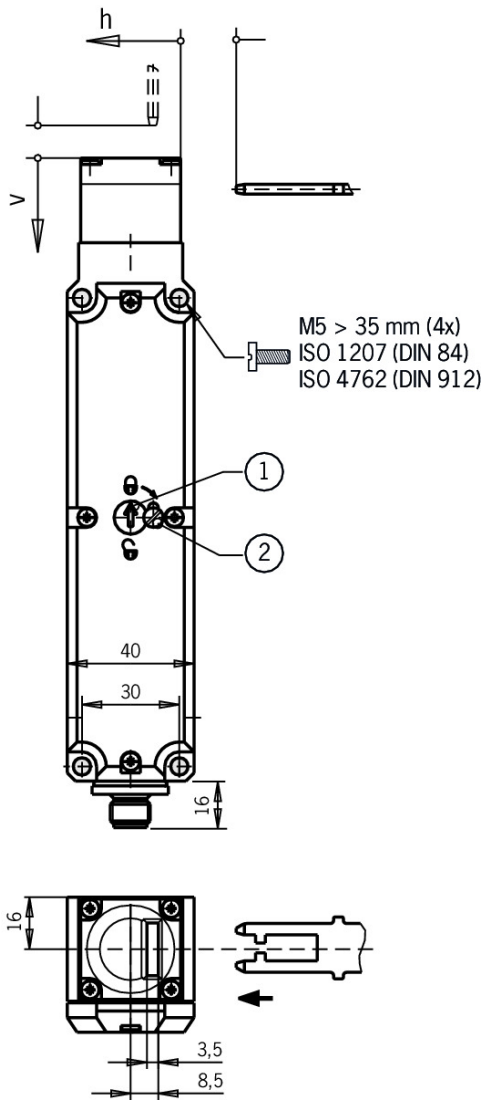

Legende

- 1 Auxiliary release
- 2 Locking screw

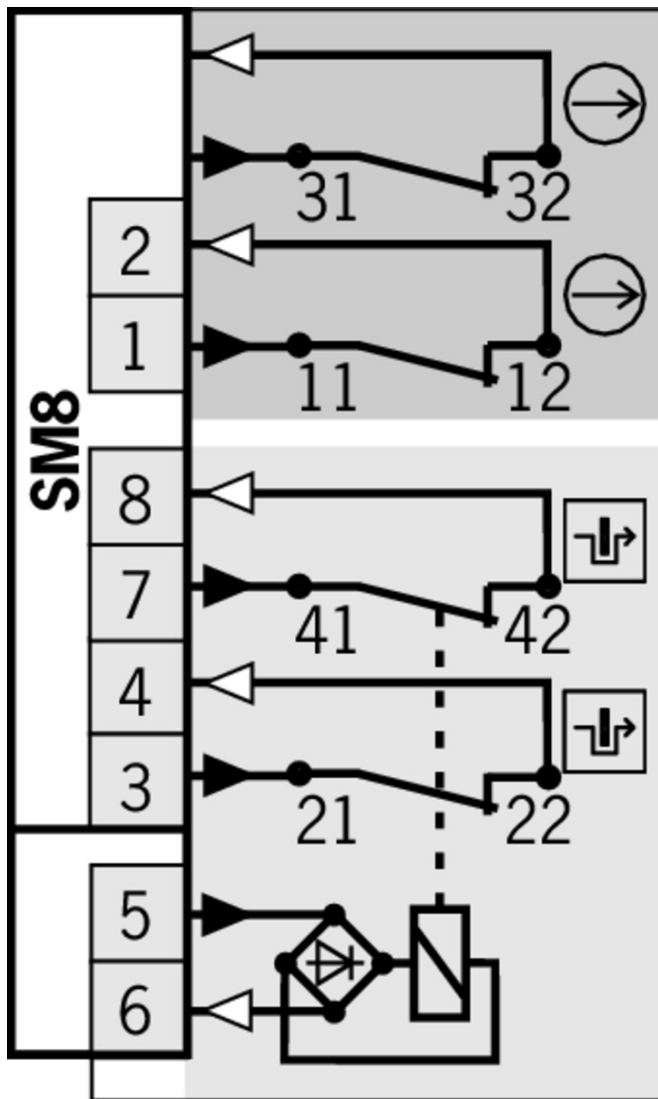

Legende

- Solenoid monitoring
- Door monitoring

Switching functions

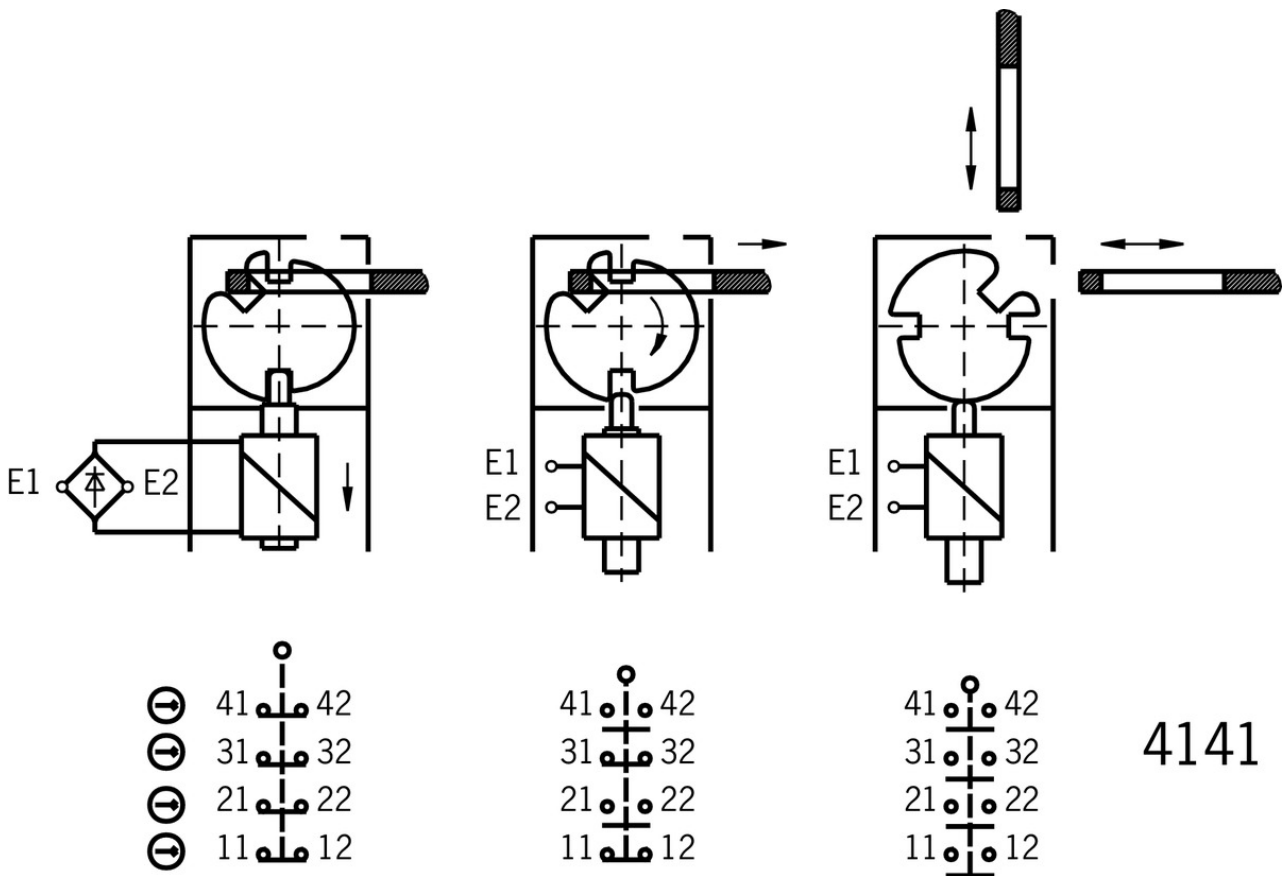

Bolt

- ✓ Bolt TP-GFK for safety switches TP and GP



096616 RIEGEL TP-GFK

✓ Features

- › Fiber glass reinforced plastic bolt
- › For doors hinged on the left or right
- › Can be locked in open position with padlocks
- › Actuator included

- ✓ Bolt BTC-T/GP... without escape release for safety switches GP and TP



106301 BTC-T/GP-S-TH-00-X

✓ Features

- › Aluminum bolt
- › For doors hinged on the left or right
- › Can be locked in open position with padlocks
- › Actuator included

- ✓ Bolt TP/GP... for safety switches GP and TP



084432 RIEGEL TP-C

✓ Features

- › Steel bolt

- › For doors hinged on the left
- › Can be locked in open position with padlocks
- › Actuator included



084430 RIEGEL TP-A

✓ Features

- › Steel bolt
- › For doors hinged on the right
- › Can be locked in open position with padlocks
- › Actuator included

✓ Bolt 0 NP/TP for safety switches NP, GP and TP



073535 RIEGEL 0 NP/TP OHNE RASTUNG

✓ Features

- › Steel bolt
- › For doors hinged on the left or right
- › Can be locked in open position with padlocks
- › Actuator included

✓ Bolt 1 NP/TP for safety switches NP, GP and TP



073536 RIEGEL 1 NP/TP 1X RASTUNG ZU

✓ Features

- › Steel bolt
- › For doors hinged on the left or right
- › Can be locked in open position with padlocks
- › Actuator included
- › Detent mechanism closed position

Actuator

✓ Actuators for safety switches NP/GP/TP



059226 BETAETIGER-P-G

✓ Features

- › Actuators made of stainless steel
- › Two stainless safety screws per actuator



070046 BETAETIGER-P-GT

✓ Features

- › Actuators made of stainless steel
- › Two stainless safety screws per actuator
- › Actuators with rubber bushings

✓ Bent actuator for safety switches NP/GP/TP, increased overtravel



074577 BETAETIGER-P-WNT

✓ Features

- › Actuators made of stainless steel

- › Two stainless safety screws per actuator
- › Actuators with rubber bushings



074571 BETAETIGER-P-WN

✓ Features

- › Actuators made of stainless steel
- › Two stainless safety screws per actuator

✓ Hinged actuator top/bottom for safety switches NP/GP/TP



070050 RADIUSBETAETIGER-P-OU

✓ Features

- › Actuators made of stainless steel
- › Two stainless safety screws per actuator
- › For doors hinged at top and bottom

✓ Bent actuator for safety switches NP/GP/TP



059227 BETAETIGER-P-W

✓ Features

- › Actuators made of stainless steel
- › Two stainless safety screws per actuator



070038 BETAETIGER-P-WT

✓ Features

- › Actuators made of stainless steel
- › Two stainless safety screws per actuator
- › Actuators with rubber bushings

✓ Actuators for safety switches NP/GP/TP, increased overtravel



074570 BETAETIGER-P-GN

✓ Features

- › Actuators made of stainless steel
- › Two stainless safety screws per actuator



074576 BETAETIGER-P-GNT

✓ Features

- › Actuators made of stainless steel
- › Two stainless safety screws per actuator
- › Actuators with rubber bushings

✓ Hinged actuator left/right for safety switches NP/GP/TP



059440 RADIUSBETAETIGER-P-LR

✓ Features

- › Actuators made of stainless steel
- › Two stainless safety screws per actuator
- › For doors hinged on right and left

- ▼ Hinged actuator top/bottom for safety switches NP/GP/TP, increased overtravel



074572 RADIUSBETAETIGER-P-OUN

▼ Features

- › Actuators made of stainless steel
- › Two stainless safety screws per actuator
- › For doors hinged at top and bottom

- ▼ Hinged actuator left/right for safety switches NP/GP/TP, increased overtravel



074573 RADIUSBETAETIGER-P-LRN

▼ Features

- › Actuators made of stainless steel
- › Two stainless safety screws per actuator
- › For doors hinged on right and left

Function expansion

- ▼ Insertion funnel for safety switches NP..A/GP/TP..A



086237 EINFUEHRTRICHTER-P

- ▼ Built-in LED



087423 EINBAULEUCHTE LED M20X1,5



095510 EINBAULEUCHTE LED-F M20X1,5

- ▼ LED set



093752 TP LED SET

▼ Features

- › LED set

- ▼ Latch spring for increased retention force

076501 RASTFEDER NP/TP

- ▼ Lock for auxiliary release for safety switches CTP/TP/STP



084177 SCHLOSS TP VERSCHIEDENSCHLIESSEND

▼ Features

- › Lock unique locking
- › Key removable in “unlocked” and “locked” positions



086236 SCHLOSS TP GLEICHSCHLIESSEND

✓ Features

- › Identical locking
- › Key removable in “unlocked” and “locked” positions



109212 SCHLOSS TP GLEICHSCHLIESSEND C2293

✓ Features

- › Identical locking
- › Key can be removed only in “locked” position

✓ Emergency unlocking for safety switches CTP/TP/STP



099877 NOTENTSPERRUNG TP/STP

✓ Lockout bar NP/GP/TP



096105 SPERREINSATZ TP

✓ Features

- › Prevents unintentional closing of the door
- › Can be secured with padlocks

✓ Release with automatic reset for safety switches CTP/TP/STP



103110 ENTRIEGELUNG RUECKSTELLEND TP/STP

✓ Wire front release



096230 AE-B-A1-02,0-096230

✓ Features

- › Can be used as escape release or emergency unlocking
- › No automatic return
- › Sheath length 2 m (rope length 6 m)



098314 AE-B-A1-04,0-098314

✓ Features

- › Can be used as escape release or emergency unlocking
- › No automatic return
- › Sheath length 4 m (rope length 6 m)



098313 AE-B-A1-03,0-098313

✓ Features

- › Can be used as escape release or emergency unlocking
- › No automatic return
- › Sheath length 3 m (rope length 6 m)

097747 AE-B-A1-02,0-F-097747

✓ Features



- › Can be used as escape release or emergency unlocking
- › automatic return
- › Sheath length 2 m (rope length 6 m)



111233 AE-B-A1-03,0-F-111233

✓ Features

- › Can be used as escape release or emergency unlocking
- › automatic return
- › Sheath length 3 m (rope length 6 m)



124770 AE-B-A1-06,0-F-124770

✓ Features

- › Can be used as escape release or emergency unlocking
- › automatic return
- › Rope length 6 m (without sheath)



125582 AE-B-A1-06,0-125582

✓ Features

- › Can be used as escape release or emergency unlocking
- › No automatic return
- › Rope length 6 m (without sheath)

✓ Handle for wire front release



099795 AY-HDL-099795

✓ Features

- › Suitable for all wire front releases

✓ Handle for escape release for safety switches TP/STP/STA



105329 FE-GRIFF

Mounting accessories

✓ Mounting plates EMP-SB for safety switches CTP, TP...A, STA, STP and TX



093456 EMP-SB

✓ Features

- › For vertical and horizontal mounting of safety switches TP...A, STA, STP and TX

✓ Mounting plates EMP-B1 for actuators for safety switches CTP, TP...A, STA, STP, TX and TZ



093457 EMP-B1

✓ Mounting plates EMP-B2 for actuators for safety switches CTP, TP...A, STA, STP, TX and TZ



093458 EMP-B2

▼ Safety screws M5 x 25

073457 M5X25/V100

▼ Features

- › Safety screws M5 x 25
 - › Packaging unit 100 pieces
-

▼ Safety screws for actuators, M5 x 10

073455 M5X10-NIRO/V100 NZ/TZ

▼ Features

- › Safety screws M5 x 10
 - › Packaging unit 100 pieces
-

▼ Safety screws for safety switches M4 x 14, large head

086232 M4X14-NIRO/V100

▼ Features

- › Safety screws M4 x 14 (large head)
 - › Packaging unit 100 pieces
-

▼ Switch bracket for bolt NP/TP



073539 SCHALTERAUFNAHME TP

▼ Features

- › Switch bracket made of steel
 - › For doors hinged on the left or right
-

▼ Switch bracket TP/STP GFK



096613 SCHALTERAUFNAHME TP/STP GFK

▼ Features

- › Switch bracket made of fiber glass reinforced plastic
 - › For left or right hinged doors
-

Connection material

▼ Connection cable with plug connector M12, 8-pin, 5m



100177 C-M12F08-08X025PV05,0-MA-100177

▼ Features

- › M12 female plug, 8-pin
- › Straight plug connector
- › PVC cable
- › Cable length 5 m
- › With flying lead



115112 C-M12F08-08X025PU05,0-MA-115112

▼ Features

- › M12 female plug, 8-pin
- › Straight plug connector
- › PUR cable
- › Cable length 5 m
- › With flying lead

▼ Connection cable with plug connector M12, 8-pin, 10m



100178 C-M12F08-08X025PV10,0-MA-100178

▼ Features

- › M12 female plug, 8-pin
- › Straight plug connector
- › PVC cable
- › Cable length 10 m
- › With flying lead



115113 C-M12F08-08X025PU10,0-MA-115113

▼ Features

- › M12 female plug, 8-pin
- › Straight plug connector
- › PUR cable
- › Cable length 10 m
- › With flying lead

▼ Connection cable with plug connector M12, 8-pin, 20m



100179 C-M12F08-08X025PV20,0-MA-100179

▼ Features

- › M12 female plug, 8-pin
- › Straight plug connector
- › PVC cable
- › Cable length 20 m
- › With flying lead



115114 C-M12F08-08X025PU20,0-MA-115114

▼ Features

- › M12 female plug, 8-pin
- › Straight plug connector
- › PUR cable
- › Cable length 20 m
- › With flying lead

▼ Connection cable with plug connector M12, 8-pin, 30m



115116 C-M12F08-08X025PV30,0-MA-115116

▼ Features

- › M12 female plug, 8-pin
- › Straight plug connector
- › PVC cable

- › Cable length 30 m
- › With flying lead



115257 C-M12F08-08X025PU30,0-MA-115257

▼ Features

- › M12 female plug, 8-pin
- › Straight plug connector
- › PUR cable
- › Cable length 30 m
- › With flying lead

Instructions

▼ Návod k použití Bezpečnostní spínač TP...

| | Doc. no. | Version | Language | Download |
|---|----------|----------|--------------|----------|
| Betriebsanleitung Sicherheitsschalter TP... Manual de instrucciones Interruptores de seguridad TP... Mode d'emploi pour les interrupteurs de sécurité TP... Operating Instructions Safety Switches TP... | 2084123 | 15-12/17 | | 5.7 MB |
| Návod k použití Bezpečnostní spínač TP... | 2084123 | 15-12/17 | | 1.5 MB |
| Driftsvejledning for sikkerhedsafbryder TP... | 2084123 | 15-12/17 | | 1.5 MB |
| Manual de instruções Chave de segurança TP... | 2084123 | 15-12/17 | | 1.5 MB |
| Istruzioni di impiego dei finecorsa di sicurezza TP... | 2084123 | 15-12/17 | | 1.5 MB |

Catalogs















▼ Bezpečnostní spínače s plastovým pouzdrém Sicherheitsschalter mit Kunststoffgehäuse Safety Switches with Plastic Housing Interruptores de seguridad con carcasa plástica Interrupteurs de sécurité avec boîtier plastique 塑料壳体 的安全开关

| | Doc. no. | Version | Language | Download |
|--|----------|----------|----------|----------|
| Sicherheitsschalter mit Kunststoffgehäuse | 096955 | 11-03/18 | | 6.6 MB |
| Interrupteurs de sécurité avec boîtier plastique | 100677 | 11-03/18 | | 6.6 MB |
| Interruptores de seguridad con carcasa plástica | 104855 | 11-03/18 | | 6.6 MB |
| Bezpečnostní spínače s plastovým pouzdrém | 121649 | 11-03/18 | | 6.6 MB |
| Safety Switches with Plastic Housing | 096956 | 11-03/18 | | 6.6 MB |
| 塑料壳体 的安全开关 | 116243 | 11-03/18 | | 6.2 MB |

Declaration of conformity

▼ EU prohlášení o shodě

Doc. no. Version Language Download

| | | | | |
|---------------------------------|---------|----------|---|--|
| EU-Konformitätserklärung | 2077153 | 25-02/17 |  |  0.3 MB |
| Declaración UE de conformidad | | |  | |
| Déclaration UE de conformité | | |  | |
| Dichiarazione di conformità | | |  | |
| EU declaration of conformity | | |  | |
| EU prohlášení o shodě | 2077153 | 25-02/17 |  |  0.5 MB |
| EU-overensstemmelseserklæring | | |  | |
| Δήλωση συμμόρφωσης της ΕΕ | | |  | |
| EU-vaatimustenmukaisuusvakuutus | | |  | |
| EU-típusbizonyítvány | | |  | |
| EU-conformiteitsverklaring | | |  | |
| Deklaracja zgodności UE | | |  | |
| Declaração de Conformidade UE | | |  | |
| Declarația de conformitate UE | | |  | |
| EÚ vyhlásenie o zhode | | |  | |

CAD data

CAD data for this item on TraceParts