

ITEM 087450 TP4-537A230SR6

Description	Technical data	Accessories	Downloads
-------------	----------------	-------------	-----------



Features

- › Auxiliary release on the front
- › With door monitoring contact
- › Increased horizontal overtravel

Approach direction

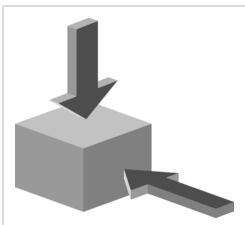

- › Figure
Horizontal and vertical
Can be adjusted in 90° steps
Increased overtravel for horizontal approach direction

Solenoid operating voltage

- › DC 230 V +10% -15%

Guard locking types

TP3 Closed-circuit current principle, guard locking by spring force. Release by applying voltage to the guard locking solenoid.

TP4 Open-circuit current principle, guard locking by applying voltage to the guard locking solenoid. Release by spring force.

Switching element

537 Slow-action switching contact 1 NC \ominus + 1 NC (door monitoring contact)

Auxiliary release

Is used for releasing the guard locking with the aid of a tool. To protect against tampering, the auxiliary release is sealed with sealing lacquer.

Approvals



Mechanical values and environment

Ambient temperature	-20 ... 55 °C
Mechanical life	1×10^6
Number of door position positively driven contacts	1
Number of NC contacts	1
Actuation frequency	1200 1/h
Locking force F_{\max}	1300 N
Locking force F_{Zh}	1000 N
Retention force	10 N
Extraction force	20 N
Actuating force	10 N

Electrical connection ratings

Rated thermal current I_{th}	4 A
Utilization category according to EN 60947-5-1	AC-15 DC-13
Rated insulation voltage U_i	250 V
Rated impulse withstand voltage U_{imp}	2,5 kV
Power consumption	11 W
Solenoid duty cycle	100 %

in combination with Actuator BETAETIGER-P-GT

Mechanical values and environment

Overtravel A B C D E	2 mm
Overtravel K L M N	1,5 mm

in combination with Actuator BETAETIGER-P-GNT

Mechanical values and environment

Overtravel A B C D E	7 mm
----------------------	------

Dimension drawing

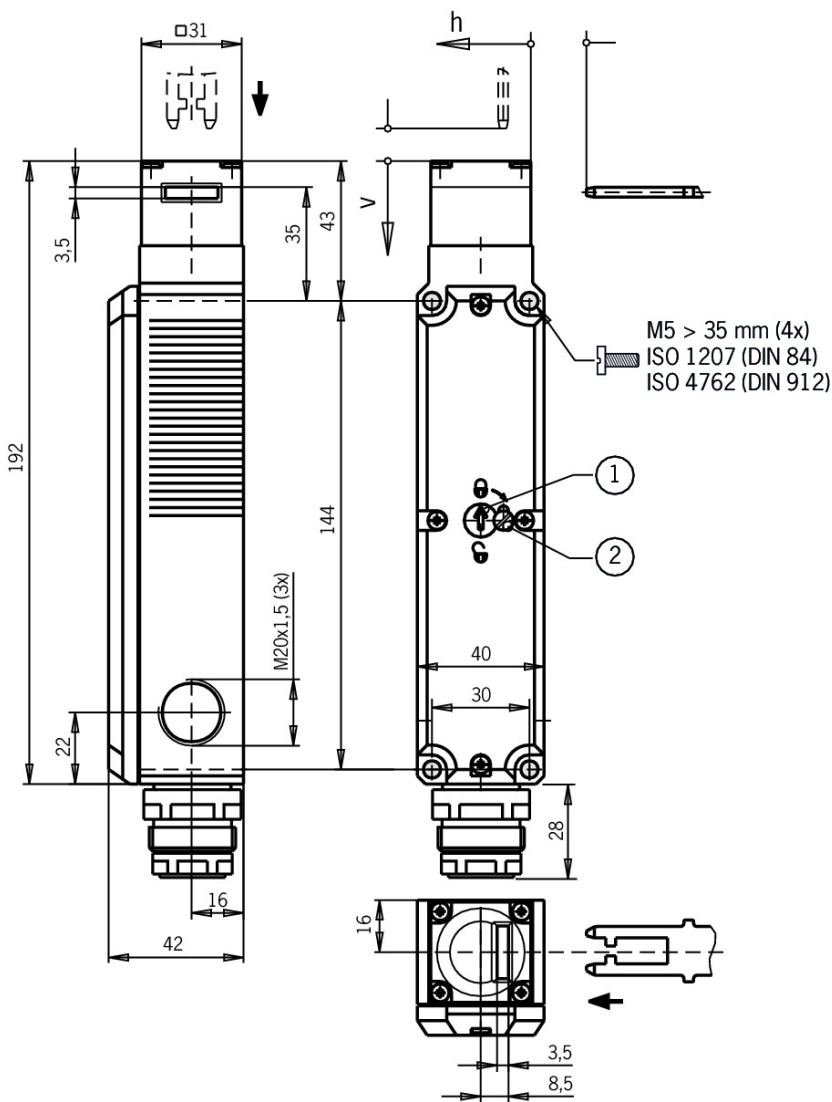

Legende

- 1 Auxiliary release
- 2 Locking screw

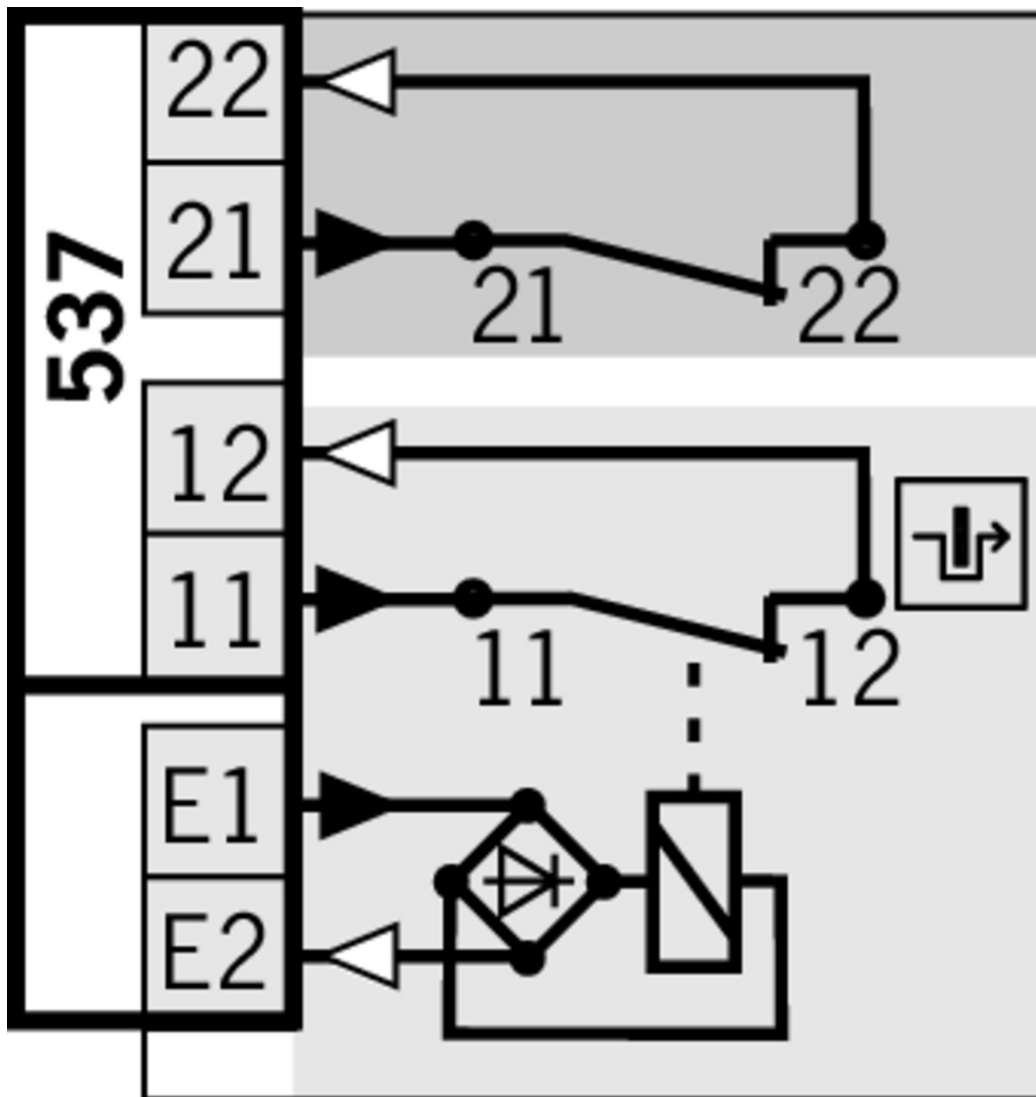

Legende

- Solenoid monitoring
- Door monitoring

Switching functions

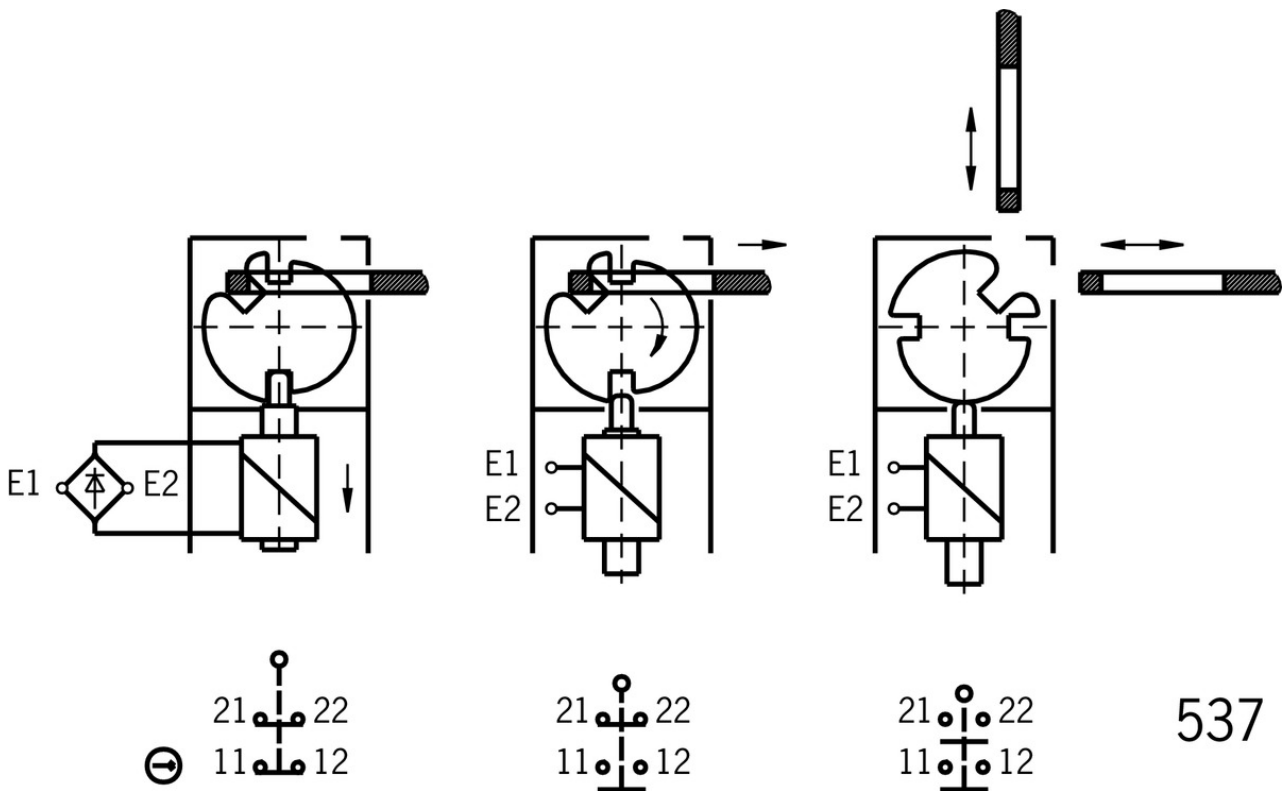

537

Actuator

Actuators for safety switches NP/GP/TP



059226 BETAETIGER-P-G

Features

- › Actuators made of stainless steel
- › Two stainless safety screws per actuator



070046 BETAETIGER-P-GT

Features

- › Actuators made of stainless steel
- › Two stainless safety screws per actuator
- › Actuators with rubber bushings

Bent actuator for safety switches NP/GP/TP



059227 BETAETIGER-P-W

Features

- › Actuators made of stainless steel
- › Two stainless safety screws per actuator



070038 BETAETIGER-P-WT

Features

- › Actuators made of stainless steel
- › Two stainless safety screws per actuator
- › Actuators with rubber bushings

▼ Actuators for safety switches NP/GP/TP, increased overtravel



074570 BETAETIGER-P-GN

▼ Features

- › Actuators made of stainless steel
- › Two stainless safety screws per actuator



074576 BETAETIGER-P-GNT

▼ Features

- › Actuators made of stainless steel
- › Two stainless safety screws per actuator
- › Actuators with rubber bushings

▼ Bent actuator for safety switches NP/GP/TP, increased overtravel



074571 BETAETIGER-P-WN

▼ Features

- › Actuators made of stainless steel
- › Two stainless safety screws per actuator



074577 BETAETIGER-P-WNT

▼ Features

- › Actuators made of stainless steel
- › Two stainless safety screws per actuator
- › Actuators with rubber bushings

▼ Hinged actuator top/bottom for safety switches NP/GP/TP



070050 RADIUSBETAETIGER-P-OU

▼ Features

- › Actuators made of stainless steel
- › Two stainless safety screws per actuator
- › For doors hinged at top and bottom

▼ Hinged actuator left/right for safety switches NP/GP/TP



059440 RADIUSBETAETIGER-P-LR

▼ Features

- › Actuators made of stainless steel
- › Two stainless safety screws per actuator
- › For doors hinged on right and left

▼ Hinged actuator top/bottom for safety switches NP/GP/TP, increased overtravel



074572 RADIUSBETAETIGER-P-OUN

▼ Features

- › Actuators made of stainless steel
- › Two stainless safety screws per actuator
- › For doors hinged at top and bottom

-
- ▼ Hinged actuator left/right for safety switches NP/GP/TP, increased overtravel



074573 RADIUSBETAETIGER-P-LRN

▼ Features

- › Actuators made of stainless steel
 - › Two stainless safety screws per actuator
 - › For doors hinged on right and left
-

Bolt

-
- ▼ Bolt 0 NP/TP for safety switches NP, GP and TP



073535 RIEGEL 0 NP/TP OHNE RASTUNG

▼ Features

- › Steel bolt
 - › For doors hinged on the left or right
 - › Can be locked in open position with padlocks
 - › Actuator included
-

- ▼ Bolt 1 NP/TP for safety switches NP, GP and TP



073536 RIEGEL 1 NP/TP 1X RASTUNG ZU

▼ Features

- › Steel bolt
 - › For doors hinged on the left or right
 - › Can be locked in open position with padlocks
 - › Actuator included
 - › Detent mechanism closed position
-

- ▼ Bolt TP/GP... for safety switches GP and TP



084430 RIEGEL TP-A

▼ Features

- › Steel bolt
 - › For doors hinged on the right
 - › Can be locked in open position with padlocks
 - › Actuator included
-



084432 RIEGEL TP-C

▼ Features

- › Steel bolt
 - › For doors hinged on the left
 - › Can be locked in open position with padlocks
 - › Actuator included
-

- ▼ Bolt TP-GFK for safety switches TP and GP

096616 RIEGEL TP-GFK

▼ Features



- › Fiber glass reinforced plastic bolt
- › For doors hinged on the left or right
- › Can be locked in open position with padlocks
- › Actuator included

▼ Bolt BTC-T/GP... without escape release for safety switches GP and TP



106301 BTC-T/GP-S-TH-00-X

▼ Features

- › Aluminum bolt
- › For doors hinged on the left or right
- › Can be locked in open position with padlocks
- › Actuator included

Function expansion

▼ Lock for auxiliary release for safety switches CTP/TP/STP



086236 SCHLOSS TP GLEICHSCHLIESSEND

▼ Features

- › Identical locking
- › Key removable in “unlocked” and “locked” positions



084177 SCHLOSS TP VERSCHIEDENSCHLIESSEND

▼ Features

- › Lock unique locking
- › Key removable in “unlocked” and “locked” positions



109212 SCHLOSS TP GLEICHSCHLIESSEND C2293

▼ Features

- › Identical locking
- › Key can be removed only in “locked” position

▼ Emergency unlocking for safety switches CTP/TP/STP



099877 NOTENTSPERRUNG TP/STP

▼ Release with automatic reset for safety switches CTP/TP/STP



103110 ENTRIEGELUNG RUECKSTELLEND TP/STP

▼ Wire front release



096230 AE-B-A1-02,0-096230

▼ Features

- › Can be used as escape release or emergency unlocking
- › No automatic return

- › Sheath length 2 m (rope length 6 m)



098313 AE-B-A1-03,0-098313

▾ Features

- › Can be used as escape release or emergency unlocking
- › No automatic return
- › Sheath length 3 m (rope length 6 m)



098314 AE-B-A1-04,0-098314

▾ Features

- › Can be used as escape release or emergency unlocking
- › No automatic return
- › Sheath length 4 m (rope length 6 m)



124770 AE-B-A1-06,0-F-124770

▾ Features

- › Can be used as escape release or emergency unlocking
- › automatic return
- › Rope length 6 m (without sheath)



125582 AE-B-A1-06,0-125582

▾ Features

- › Can be used as escape release or emergency unlocking
- › No automatic return
- › Rope length 6 m (without sheath)



111233 AE-B-A1-03,0-F-111233

▾ Features

- › Can be used as escape release or emergency unlocking
- › automatic return
- › Sheath length 3 m (rope length 6 m)



097747 AE-B-A1-02,0-F-097747

▾ Features

- › Can be used as escape release or emergency unlocking
- › automatic return
- › Sheath length 2 m (rope length 6 m)

▾ LED set



093752 TP LED SET

▾ Features

- › LED set

▾ Insertion funnel for safety switches NP../GP/TP../A



086237 EINFUEHRTRICHTER-P

▼ Built-in LED



087423 EINBAULEUCHTE LED M20X1,5



095510 EINBAULEUCHTE LED-F M20X1,5

▼ Lockout bar NP/GP/TP



096105 SPERREINSATZ TP

▼ Features

- › Prevents unintentional closing of the door
- › Can be secured with padlocks

▼ Latch spring for increased retention force

076501 RASTFEDER NP/TP

▼ Handle for wire front release



099795 AY-HDL-099795

▼ Features

- › Suitable for all wire front releases

▼ Handle for escape release for safety switches TP/STP/STA



105329 FE-GRIFF

Mounting accessories

▼ Mounting plates EMP-B2 for actuators for safety switches CTP, TP...A, STA, STP, TX and TZ



093458 EMP-B2

▼ Mounting plates EMP-SB for safety switches CTP, TP...A, STA, STP and TX



093456 EMP-SB

▼ Features

- › For vertical and horizontal mounting of safety switches TP...A, STA, STP and TX

▼ Mounting plates EMP-B1 for actuators for safety switches CTP, TP...A, STA, STP, TX and TZ

093457 EMP-B1



Safety screws M5 x 25

073457 M5X25/V100

Features

- › Safety screws M5 x 25
- › Packaging unit 100 pieces



Safety screws for actuators, M5 x 10

073455 M5X10-NIRO/V100 NZ/TZ

Features

- › Safety screws M5 x 10
- › Packaging unit 100 pieces



Safety screws for safety switches M4 x 14, large head

086232 M4X14-NIRO/V100

Features

- › Safety screws M4 x 14 (large head)
- › Packaging unit 100 pieces



Switch bracket for bolt NP/TP



073539 SCHALTERAUFNAHME TP

Features

- › Switch bracket made of steel
- › For doors hinged on the left or right



Switch bracket TP/STP GFK



096613 SCHALTERAUFNAHME TP/STP GFK

Features

- › Switch bracket made of fiber glass reinforced plastic
- › For left or right hinged doors

Connection material



Plug connector SR6



013176 SR6EF

Features

- › Crimp contacts
- › Coding shells



024999 SR6WFPG11R

Features

- › Socket crimp contacts

- › 6-pin+PE
 - › Contact carrier can be adjusted in 7 outlet directions
-

013178 SR6K

☑ Features

- › Coding for plug connector SR6
 - › Coding shells
-

087180 SR6AM2-M20

☑ Features

- › Crimp contacts
 - › Male socket
-

☑ Connection cable with plug connector SR6, 5m



077632 C-M26F07-07X1,0PU05,0-MA-077632

☑ Features

- › Female plug SR6, 6-pin + PE
 - › Straight plug connector
 - › PUR cable
 - › Cable length 5 m
 - › With flying lead
-

☑ Connection cable with plug connector SR6, 10m



077633 C-M26F07-07X1,0PU10,0-MA-077633

☑ Features

- › Female plug SR6, 6-pin + PE
 - › Straight plug connector
 - › PUR cable
 - › Cable length 10 m
 - › With flying lead
-

☑ Connection cable with plug connector SR6, 15m



077634 C-M26F07-07X1,0PU15,0-MA-077634

☑ Features

- › Female plug SR6, 6-pin + PE
 - › Straight plug connector
 - › PUR cable
 - › Cable length 15 m
 - › With flying lead
-

☑ Connection cable with plug connector SR6, 20m



098128 C-M26F07-07X1,0PU20,0-MA-098128

☑ Features

- › Female plug SR6, 6-pin + PE
- › Straight plug connector
- › PUR cable
- › Cable length 20 m













Instructions

▼ Návod k použití Bezpečnostní spínač TP...

	Doc. no.	Version	Language	Download
Betriebsanleitung Sicherheitsschalter TP... Manual de instrucciones Interruptores de seguridad TP... Mode d'emploi pour les interrupteurs de sécurité TP... Operating Instructions Safety Switches TP...	2084123	15-12/17	   	 5.7 MB
Návod k použití Bezpečnostní spínač TP...	2084123	15-12/17		 1.5 MB
Driftsvejledning for sikkerhedsafbryder TP...	2084123	15-12/17		 1.5 MB
Manual de instruções Chave de segurança TP...	2084123	15-12/17		 1.5 MB
Istruzioni di impiego dei finecorsa di sicurezza TP...	2084123	15-12/17		 1.5 MB







Catalogs











▼ Bezpečnostní spínače s plastovým pouzdrém Sicherheitsschalter mit Kunststoffgehäuse Safety Switches with Plastic Housing Interruptores de seguridad con carcasa plástica Interrupteurs de sécurité avec boîtier plastique 塑料壳体 的安全开关

	Doc. no.	Version	Language	Download
Sicherheitsschalter mit Kunststoffgehäuse	096955	11-03/18		 6.6 MB
Interrupteurs de sécurité avec boîtier plastique	100677	11-03/18		 6.6 MB
Interruptores de seguridad con carcasa plástica	104855	11-03/18		 6.6 MB
Bezpečnostní spínače s plastovým pouzdrém	121649	11-03/18		 6.6 MB
Safety Switches with Plastic Housing	096956	11-03/18		 6.6 MB
塑料壳体 的安全开关	116243	11-03/18		 6.2 MB

Declaration of conformity

▼ EU prohlášení o shodě

	Doc. no.	Version	Language	Download
EU-Konformitätserklärung Declaración UE de conformidad Déclaration UE de conformité Dichiarazione di conformità EU declaration of conformity	2077153	25-02/17	    	 0.3 MB

EU prohlášení o shodě	2077153	25-02/17		 0.5 MB
EU-overensstemmelseserklæring				
Δήλωση συμμόρφωσης της ΕΕ				
EU-vaatimustenmukaisuusvakuutus				
EU-típusbizonyítvány				
EU-conformiteitsverklaring				
Deklaracja zgodności UE				
Declaração de Conformidade UE				
Declarația de conformitate UE				
EÚ vyhlásenie o zhode				

CAD data

CAD data for this item on TraceParts