

## ITEM 098403 TP3-4131A024L024M

Description	Technical data	Accessories	Downloads
-------------	----------------	-------------	-----------



### Features

- › Auxiliary release on the front
- › With door monitoring contact
- › Increased horizontal overtravel

### Approach direction



- › Figure  
Horizontal and vertical  
Can be adjusted in 90° steps  
Increased overtravel for horizontal approach direction

### Solenoid operating voltage

- › AC/DC 24 V +10%, -15%

## LED function display

A function display (2 LEDs, red and green) is available for the following voltage range:

› AC/DC 24 V +10%, -15%

---

## Guard locking type

**TP3** Closed-circuit current principle, guard locking by spring force. Release by applying voltage to the guard locking solenoid.

---

## Switching element

**4131** Slow-action switching contact 2 NC  $\ominus$  + 1 NO + 1 NO (door monitoring contact)

---

## Auxiliary release

Is used for releasing the guard locking with the aid of a tool. To protect against tampering, the auxiliary release is sealed with sealing lacquer.

## Approvals



## Mechanical values and environment

Ambient temperature	-20 ... 55 °C
Mechanical life	$1 \times 10^6$
Number of door position positively driven contacts	2
Number of NO contacts	2
Actuation frequency	1200 1/h
Locking force $F_{max}$	1300 N
Locking force $F_{Zh}$	1000 N
Retention force	10 N
Extraction force	20 N
Actuating force	10 N

## Electrical connection ratings

Rated thermal current $I_{th}$	4 A
Utilization category according to EN 60947-5-1	AC-15 DC-13
Rated insulation voltage $U_i$	250 V

Rated impulse withstand voltage $U_{imp}$	2,5 kV
Power consumption	8 W
Solenoid duty cycle	100 %
Connection cross-section	0,34 ... 1,5 mm <sup>2</sup>

**in combination with Actuator BETAETIGER-P-GT**

**Mechanical values and environment**

Overtravel A B C D E	2 mm
Overtravel K L M N	1,5 mm

**in combination with Actuator BETAETIGER-P-GNT**

**Mechanical values and environment**

Overtravel A B C D E	7 mm
----------------------	------

## Dimension drawing

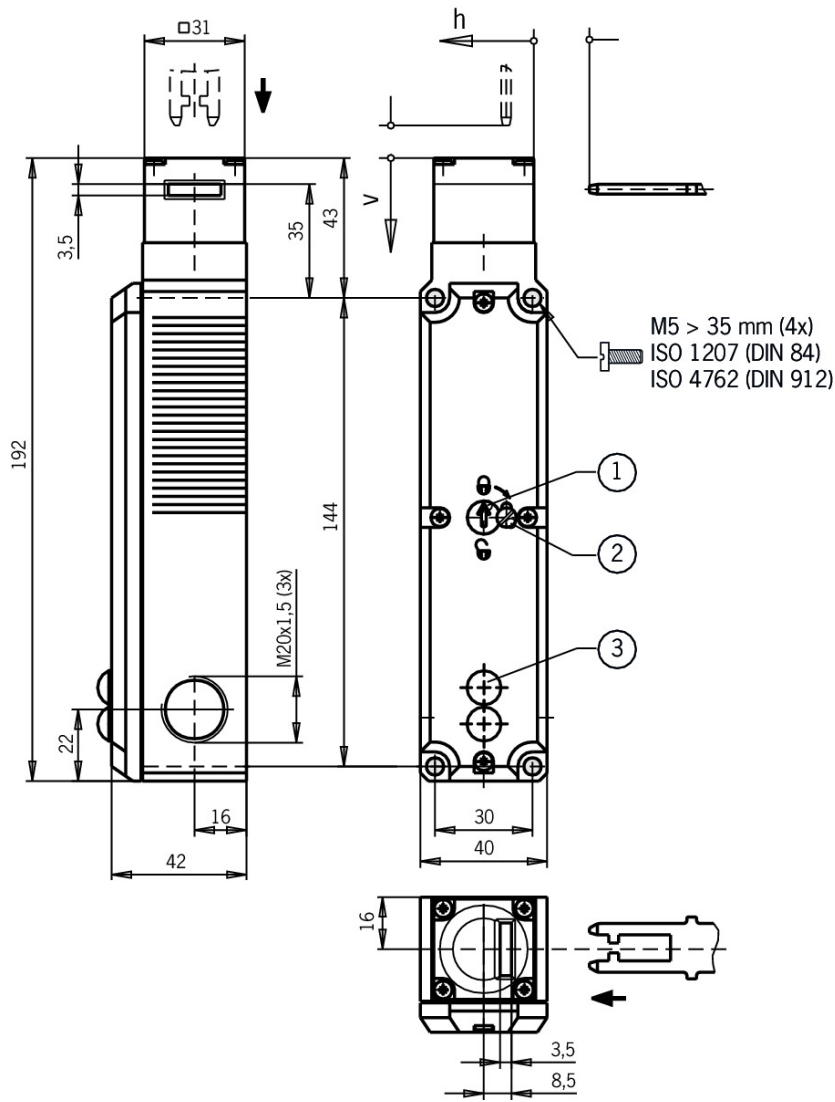

## Legende

- 1 Auxiliary release
- 2 Locking screw
- 3 LED indicator

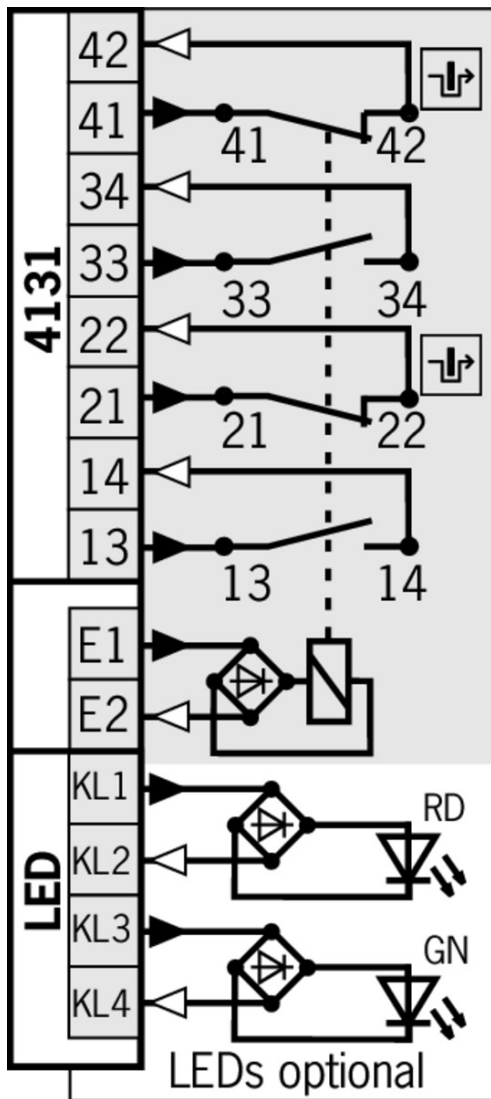

**Legende**

- Solenoid monitoring
- Door monitoring

## Switching functions

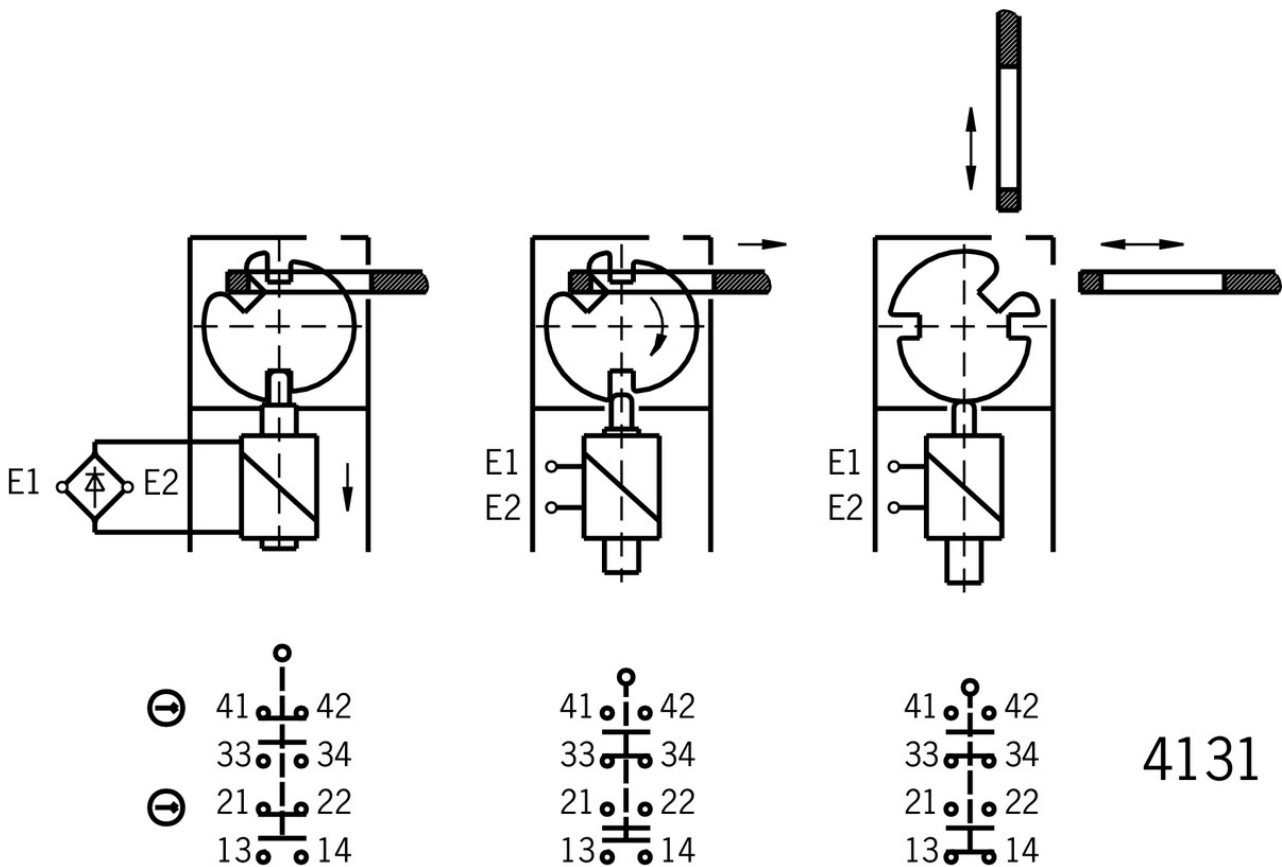

## Actuator

### Actuators for safety switches NP/GP/TP



#### **059226** BETAETIGER-P-G

##### Features

- › Actuators made of stainless steel
- › Two stainless safety screws per actuator



#### **070046** BETAETIGER-P-GT

##### Features

- › Actuators made of stainless steel
- › Two stainless safety screws per actuator
- › Actuators with rubber bushings

### Bent actuator for safety switches NP/GP/TP



#### **059227** BETAETIGER-P-W

##### Features

- › Actuators made of stainless steel
- › Two stainless safety screws per actuator



#### **070038** BETAETIGER-P-WT

##### Features

- › Actuators made of stainless steel
  - › Two stainless safety screws per actuator
  - › Actuators with rubber bushings
- 

▼ Actuators for safety switches NP/GP/TP, increased overtravel



**074570** BETAETIGER-P-GN

▼ Features

- › Actuators made of stainless steel
  - › Two stainless safety screws per actuator
- 



**074576** BETAETIGER-P-GNT

▼ Features

- › Actuators made of stainless steel
  - › Two stainless safety screws per actuator
  - › Actuators with rubber bushings
- 

▼ Bent actuator for safety switches NP/GP/TP, increased overtravel



**074571** BETAETIGER-P-WN

▼ Features

- › Actuators made of stainless steel
  - › Two stainless safety screws per actuator
- 



**074577** BETAETIGER-P-WNT

▼ Features

- › Actuators made of stainless steel
  - › Two stainless safety screws per actuator
  - › Actuators with rubber bushings
- 

▼ Hinged actuator top/bottom for safety switches NP/GP/TP



**070050** RADIUSBETAETIGER-P-OU

▼ Features

- › Actuators made of stainless steel
  - › Two stainless safety screws per actuator
  - › For doors hinged at top and bottom
- 

▼ Hinged actuator left/right for safety switches NP/GP/TP, increased overtravel



**074573** RADIUSBETAETIGER-P-LRN

▼ Features

- › Actuators made of stainless steel
  - › Two stainless safety screws per actuator
  - › For doors hinged on right and left
- 

▼ Hinged actuator top/bottom for safety switches NP/GP/TP, increased overtravel

**074572** RADIUSBETAETIGER-P-OUN

▼ Features



- › Actuators made of stainless steel
- › Two stainless safety screws per actuator
- › For doors hinged at top and bottom

---

▼ Hinged actuator left/right for safety switches NP/GP/TP



**059440** RADIUSBETAETIGER-P-LR

▼ Features

- › Actuators made of stainless steel
- › Two stainless safety screws per actuator
- › For doors hinged on right and left

---

## Function expansion

▼ Lock for auxiliary release for safety switches CTP/TP/STP



**109212** SCHLOSS TP GLEICHSCHLIESSEND C2293

▼ Features

- › Identical locking
- › Key can be removed only in “locked” position



**084177** SCHLOSS TP VERSCHIEDENSCHLIESSEND

▼ Features

- › Lock unique locking
- › Key removable in “unlocked” and “locked” positions



**086236** SCHLOSS TP GLEICHSCHLIESSEND

▼ Features

- › Identical locking
- › Key removable in “unlocked” and “locked” positions

---

▼ Wire front release



**096230** AE-B-A1-02,0-096230

▼ Features

- › Can be used as escape release or emergency unlocking
- › No automatic return
- › Sheath length 2 m (rope length 6 m)



**098313** AE-B-A1-03,0-098313

▼ Features

- › Can be used as escape release or emergency unlocking
- › No automatic return
- › Sheath length 3 m (rope length 6 m)



**098314** AE-B-A1-04,0-098314

▼ Features

- › Can be used as escape release or emergency unlocking
- › No automatic return

- › Sheath length 4 m (rope length 6 m)



**111233** AE-B-A1-03,0-F-111233

☑ Features

- › Can be used as escape release or emergency unlocking
- › automatic return
- › Sheath length 3 m (rope length 6 m)



**124770** AE-B-A1-06,0-F-124770

☑ Features

- › Can be used as escape release or emergency unlocking
- › automatic return
- › Rope length 6 m (without sheath)



**125582** AE-B-A1-06,0-125582

☑ Features

- › Can be used as escape release or emergency unlocking
- › No automatic return
- › Rope length 6 m (without sheath)



**097747** AE-B-A1-02,0-F-097747

☑ Features

- › Can be used as escape release or emergency unlocking
- › automatic return
- › Sheath length 2 m (rope length 6 m)

☑ Handle for wire front release



**099795** AY-HDL-099795

☑ Features

- › Suitable for all wire front releases

☑ Release with automatic reset for safety switches CTP/TP/STP



**103110** ENTRIEGELUNG RUECKSTELLEND TP/STP

☑ LED set



**093752** TP LED SET

☑ Features

- › LED set

☑ Emergency unlocking for safety switches CTP/TP/STP



**099877** NOTENTSPERRUNG TP/STP

- ▼ Latch spring for increased retention force

**076501** RASTFEDER NP/TP

---

- ▼ Lockout bar NP/GP/TP



**096105** SPERREINSATZ TP

- ▼ Features

- › Prevents unintentional closing of the door
  - › Can be secured with padlocks
- 

- ▼ Built-in LED



**095510** EINBAULEUCHTE LED-F M20X1,5



**087423** EINBAULEUCHTE LED M20X1,5

---

- ▼ Insertion funnel for safety switches NP../GP/TP../A



**086237** EINFUEHRTRICHTER-P

---

- ▼ Handle for escape release for safety switches TP/STP/STA



**105329** FE-GRIFF

---

## Bolt

- ▼ Bolt BTC-T/GP... without escape release for safety switches GP and TP



**106301** BTC-T/GP-S-TH-00-X

- ▼ Features

- › Aluminum bolt
  - › For doors hinged on the left or right
  - › Can be locked in open position with padlocks
  - › Actuator included
- 

- ▼ Bolt TP-GFK for safety switches TP and GP



**096616** RIEGEL TP-GFK

- ▼ Features

- › Fiber glass reinforced plastic bolt
  - › For doors hinged on the left or right
  - › Can be locked in open position with padlocks
  - › Actuator included
-

▼ Bolt TP/GP... for safety switches GP and TP



**084432** RIEGEL TP-C

▼ Features

- › Steel bolt
- › For doors hinged on the left
- › Can be locked in open position with padlocks
- › Actuator included



**084430** RIEGEL TP-A

▼ Features

- › Steel bolt
- › For doors hinged on the right
- › Can be locked in open position with padlocks
- › Actuator included

▼ Bolt 1 NP/TP for safety switches NP, GP and TP



**073536** RIEGEL 1 NP/TP 1X RASTUNG ZU

▼ Features

- › Steel bolt
- › For doors hinged on the left or right
- › Can be locked in open position with padlocks
- › Actuator included
- › Detent mechanism closed position

▼ Bolt 0 NP/TP for safety switches NP, GP and TP



**073535** RIEGEL 0 NP/TP OHNE RASTUNG

▼ Features

- › Steel bolt
- › For doors hinged on the left or right
- › Can be locked in open position with padlocks
- › Actuator included

## Mounting accessories

▼ Mounting plates EMP-SB for safety switches CTP, TP...A, STA, STP and TX



**093456** EMP-SB

▼ Features

- › For vertical and horizontal mounting of safety switches TP...A, STA, STP and TX

▼ Mounting plates EMP-B2 for actuators for safety switches CTP, TP...A, STA, STP, TX and TZ



**093458** EMP-B2

- ▼ Mounting plates EMP-B1 for actuators for safety switches CTP, TP...A, STA, STP, TX and TZ



**093457** EMP-B1

- ▼ Safety screws M5 x 25

**073457** M5X25/V100

- ▼ Features

- › Safety screws M5 x 25
- › Packaging unit 100 pieces

- ▼ Safety screws for actuators, M5 x 10

**073455** M5X10-NIRO/V100 NZ/TZ

- ▼ Features

- › Safety screws M5 x 10
- › Packaging unit 100 pieces

- ▼ Safety screws for safety switches M4 x 14, large head

**086232** M4X14-NIRO/V100

- ▼ Features

- › Safety screws M4 x 14 (large head)
- › Packaging unit 100 pieces

- ▼ Switch bracket for bolt NP/TP



**073539** SCHALTERAUFNAHME TP

- ▼ Features

- › Switch bracket made of steel
- › For doors hinged on the left or right

- ▼ Switch bracket TP/STP GFK



**096613** SCHALTERAUFNAHME TP/STP GFK

- ▼ Features

- › Switch bracket made of fiber glass reinforced plastic
- › For left or right hinged doors

## Connection material

- ▼ Cable glands M20x1.5



**086233** EKPM20/06 086233













## Instructions

### ▼ Návod k použití Bezpečnostní spínač TP...

	Doc. no.	Version	Language	Download
Betriebsanleitung Sicherheitsschalter TP...	2084123	15-12/17	   	 5.7 MB
Manual de instrucciones Interruptores de seguridad TP...				
Mode d'emploi pour les interrupteurs de sécurité TP...				
Operating Instructions Safety Switches TP...				
Návod k použití Bezpečnostní spínač TP...	2084123	15-12/17		 1.5 MB
Driftsvejlledning for sikkerhedsafbryder TP...	2084123	15-12/17		 1.5 MB
Manual de instruções Chave de segurança TP...	2084123	15-12/17		 1.5 MB
Istruzioni di impiego dei finecorsa di sicurezza TP...	2084123	15-12/17		 1.5 MB

## Catalogs

### ▼ Bezpečnostní spínače s plastovým pouzdem Sicherheitsschalter mit Kunststoffgehäuse Safety Switches with Plastic Housing Interruptores de seguridad con carcasa plástica Interrupteurs de sécurité avec boîtier plastique 塑料壳体 的安全开关

	Doc. no.	Version	Language	Download
Sicherheitsschalter mit Kunststoffgehäuse	096955	11-03/18		 6.6 MB
Interrupteurs de sécurité avec boîtier plastique	100677	11-03/18		 6.6 MB
Interruptores de seguridad con carcasa plástica	104855	11-03/18		 6.6 MB
Bezpečnostní spínače s plastovým pouzdem	121649	11-03/18		 6.6 MB
Safety Switches with Plastic Housing	096956	11-03/18		 6.6 MB
塑料壳体 的安全开关	116243	11-03/18		 6.2 MB

## Declaration of conformity

### ▼ EU prohlášení o shodě

	Doc. no.	Version	Language	Download
EU-Konformitätserklärung Declaración UE de conformidad Déclaration UE de conformité Dichiarazione di conformità EU declaration of conformity	2077153	25-02/17	    	 0.3 MB
EU prohlášení o shodě EU-overensstemmelseserklæring Δήλωση συμμόρφωσης της ΕΕ EU-vaatimustenmukaisuusvakuutus EU-típusbizonyítvány EU-conformiteitsverklaring Deklaracja zgodności UE Declaração de Conformidade UE Declarația de conformitate UE EÚ vyhlásenie o zhode	2077153	25-02/17	        	 0.5 MB

## **CAD data**

CAD data for this item on TraceParts