

ITEM 082928 TX2C-A024M

Description	Technical data	Accessories	Downloads
-------------	----------------	-------------	-----------



Features

- › Auxiliary release on the front
- › With door monitoring contact

Approach direction

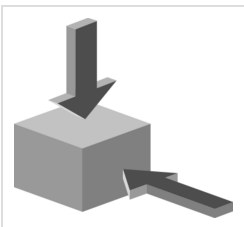

- › Figure
Horizontal and vertical
Can be adjusted in 90° steps

Solenoid operating voltage

- › AC/DC 24 V +10%, -15%

LED function display

The switch has a function display (2 LEDs, red and green). The LED voltage is same as the solenoid operating voltage.

Guard locking type

TX2 Open-circuit current principle, guard locking by applying voltage to the solenoid. Release by spring force.

Switching element

ETX Slow-action switching contact 2 NC \oplus / 1 NO + 1 NO (door monitoring
C contact)

Auxiliary release

Is used for releasing the guard locking with the aid of a tool. The auxiliary release must be sealed to prevent tampering (for example with sealing lacquer).

Approvals



Mechanical values and environment

Housing material	Die-cast alloy, cathodically dipped
Weight	Net 0,8 kg
Ambient temperature	-20 ... 80 °C
Degree of protection	IP67
Mechanical life	1 x 10 ⁶
Contact material	Silver alloy, gold flashed
Switching principle	Slow-action switching contact
Installation position	Any
Number of door position NO contacts	1
Number of guard lock monitoring positively driven contacts	2
Number of guard lock monitoring NO contacts	1
Connection	3 x M20 x 1.5
Approach speed	max. 20 m/min
Actuation frequency	1200 1/h
Guard locking principle	Open-circuit current principle
Locking force F _{max}	1700 N

Locking force F_{Zh}	1300 N
Retention force	20 N
Extraction force	35 N
Actuating force	35 N
Insertion depth	min.32 mm

Electrical connection ratings

Rated thermal current I_{th}	4 A
Utilization category according to EN 60947-5-1	AC-15 4A 230V DC-13 4A 24V
Solenoid operating voltage	AC/DC 24 V -15% ... +10%
Short circuit protection according to IEC 60269-1	(Fuse) 4A gG
Rated insulation voltage U_i	250 V
Rated impulse withstand voltage U_{imp}	2,5 kV
Switching voltage	Min. at 10mA 12 V
Switching current	Min. at 24V 1 mA
Power consumption	8 W
Solenoid duty cycle	100 %
Connection cross-section	0,34 ... 1,5 mm ²
LED indicator	Operating voltage corresponds to the solenoid voltage ^[1]

Reliability values acc. to EN ISO 13849-1

	Monitoring of guard locking and the safety guard position
B10 _D	6×10^6

in combination with Actuator BETAETIGER-X-GQ, 079740

Mechanical values and environment

Overtravel	1 mm
------------	------

in combination with Actuator BETAETIGER-X-GNQ, 079742, 098082, 097906

Mechanical values and environment

Overtravel	8 mm
------------	------

[1] 2 LEDs; green, red

Dimension drawing

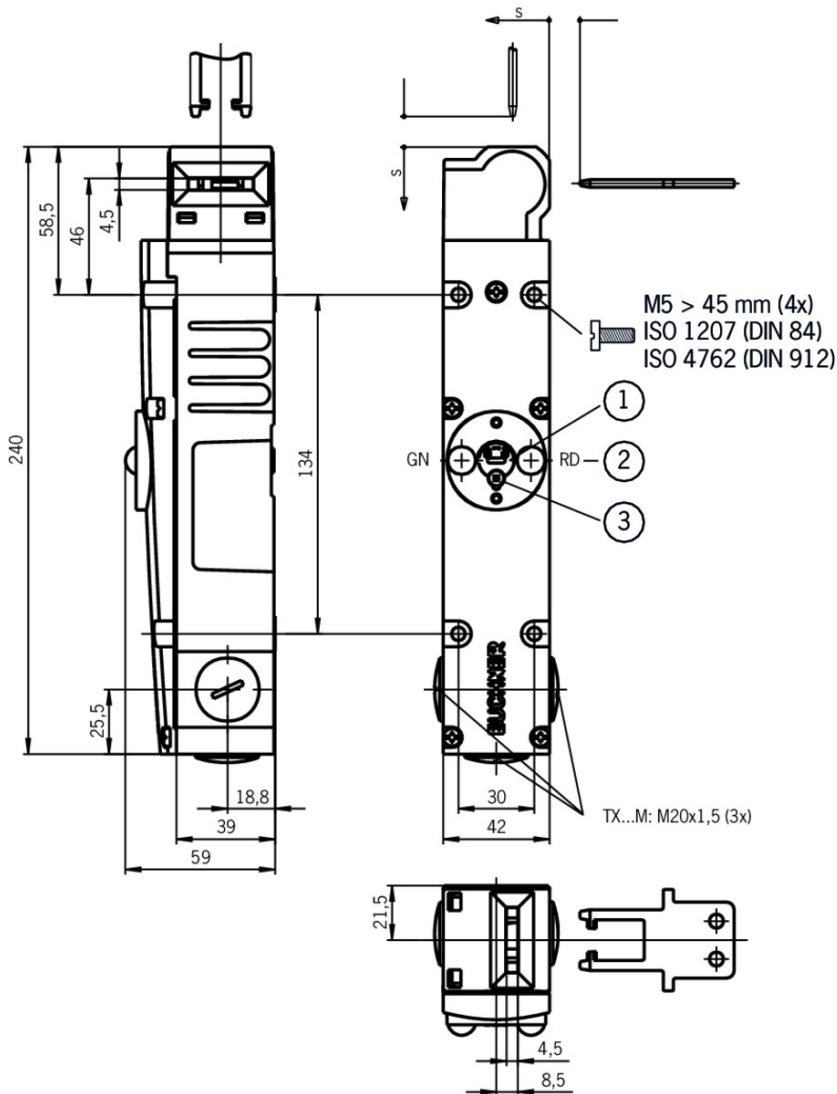

Legende

- 1 Auxiliary release
- 2 LED indicator
- 3 Locking screw
- s Insertion depth

ETX C

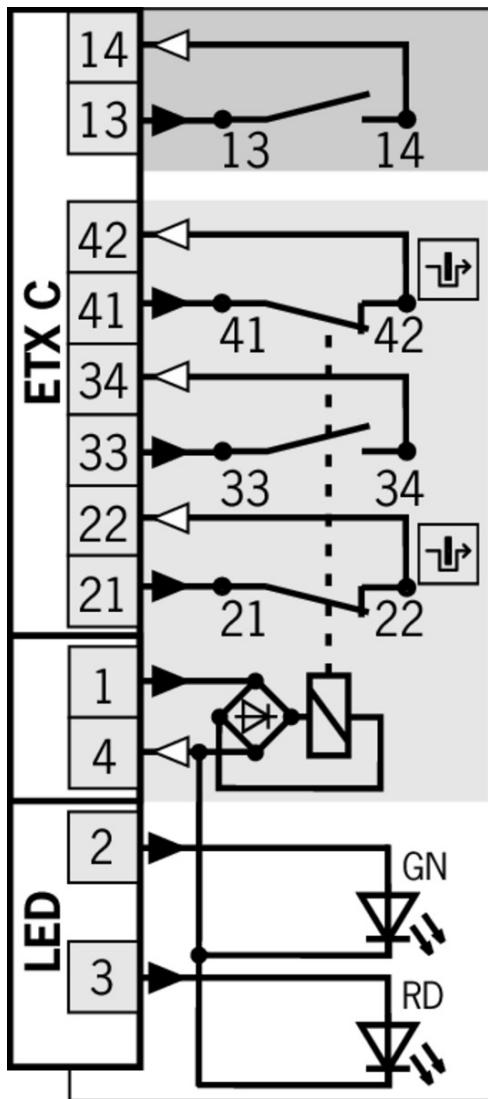

Switching functions

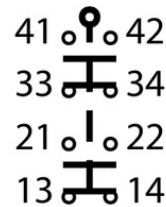
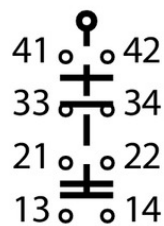
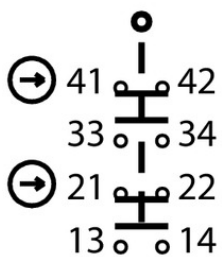
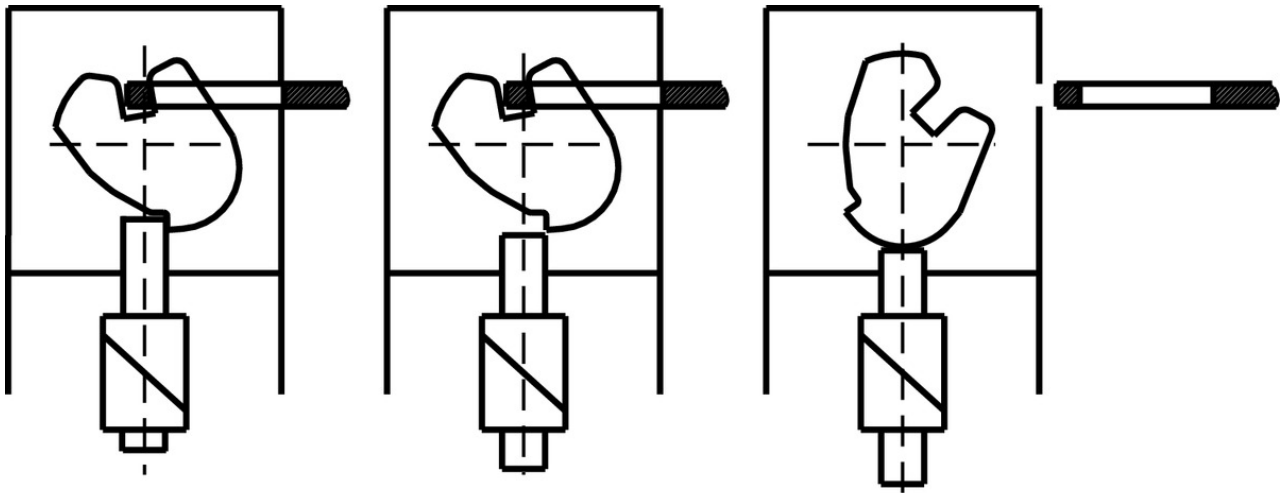

ETX C

Actuator

- ▼ Bent actuator for safety switches NX/TX



079740 BETAETIGER-X-WQ

▼ Features

- › Actuators made of stainless steel
- › Two stainless safety screws per actuator
- › With rubber bush

- ▼ Actuators for safety switches NX/TX



079739 BETAETIGER-X-GQ

▼ Features

- › Actuators made of stainless steel
- › Two stainless safety screws per actuator
- › With rubber bush

- ▼ Actuators for safety switches NX/TX, increased overtravel



079741 BETAETIGER-X-GNQ

▼ Features

- › Actuators made of stainless steel
- › Two stainless safety screws per actuator
- › With rubber bush

- ▼ Hinged actuator left/right for safety switches NX/TX



098082 RADIUSBETAETIGER-X-LR-N

▼ Features

- › Actuators made of stainless steel
 - › Two stainless safety screws per actuator
-

- ▼ Hinged actuator top/bottom for safety switches NX/TX



097906 RADIUSBETAETIGER-X-OU-N

▼ Features

- › Actuators made of stainless steel
 - › Two stainless safety screws per actuator
-

- ▼ Bent actuator for safety switches NX/TX, increased overtravel



079742 BETAETIGER-X-WNQ

▼ Features

- › Actuators made of stainless steel
 - › Two stainless safety screws per actuator
 - › With rubber bush
-

Mounting accessories

- ▼ Mounting plates EMP-B1 for actuators for safety switches CTP, TP...A, STA, STP, TX and TZ



093457 EMP-B1

- ▼ Mounting plates EMP-SB for safety switches CTP, TP...A, STA, STP and TX



093456 EMP-SB

▼ Features

- › For vertical and horizontal mounting of safety switches TP...A, STA, STP and TX
-

- ▼ Mounting plates EMP-B2 for actuators for safety switches CTP, TP...A, STA, STP, TX and TZ



093458 EMP-B2

Bolt

- ▼ Bolt TX-C for safety switches TX and NX



082991 RIEGEL TX-C

▼ Features

- › Steel bolt
- › For doors hinged on the left

- › Can be locked in open position with padlocks
- › Actuator and switch bracket included

▼ Bolt TX-A for safety switches TX and NX



082990 RIEGEL TX-A

▼ Features

- › Steel bolt
- › For doors hinged on the right
- › Can be locked in open position with padlocks
- › Actuator and switch bracket included

Function expansion

▼ Lock for mechanical release for safety switches TX



079795 SCHLOSS TX GLEICHSCHLIESSEND



079796 SCHLOSS TX VERSCHIEDENSCHLIESSEND

▼ Release with automatic reset for safety switches TX



094773 ENTRIEGELUNG RUECKSTELLEND TX1/3

▼ Lockout mechanism NX/TX



096098 SPERREINSATZ TX

▼ Features

- › Prevents unintentional closing of the door
- › Can be secured with padlocks

▼ Emergency unlocking for safety switches TX



094771 NOTENTSPERRUNG TX

Connection material

▼ Cable glands M20x1.5



077683 EKVM20/06



077684 EKVM20/09





Spare parts

Lead seal kit

087256 PLOMBENSATZ C1937













Instructions

Betriebsanleitung Sicherheitsschalter TX...

	Doc. no.	Version	Language	Download
Betriebsanleitung Sicherheitsschalter TX...	079777	07-01/17		 4.4 MB
Mode d'emploi pour les interrupteurs de sécurité TX...				
Istruzioni di impiego dei finecorsa di sicurezza TX...				
Operating Instructions Safety Switches TX...				







Catalogs











Sicherheitsschalter mit Metallgehäuse Safety Switches with Metal Housing Bezpečnostní spínače s kovovým pouzdem Interrupteurs de sécurité avec boîtier métallique 金属壳体 的安全开关 Interruptores de seguridad con carcasa metálica

	Doc. no.	Version	Language	Download
Sicherheitsschalter mit Metallgehäuse	100319	11-03/18		 7.9 MB
Interrupteurs de sécurité avec boîtier métallique	100676	11-03/18		 7.9 MB
Interruptores de seguridad con carcasa metálica	104856	11-03/18		 14.0 MB
Safety Switches with Metal Housing	100369	11-03/18		 7.9 MB
Bezpečnostní spínače s kovovým pouzdem	121650	11-03/18		 7.9 MB
金属壳体 的安全开关	102453	11-03/18		 8.2 MB

Declaration of conformity

EU prohlášení o shodě

	Doc. no.	Version	Language	Download
EU-Konformitätserklärung	2077153	25-02/17		 0.3 MB
Declaración UE de conformidad				
Déclaration UE de conformité				
Dichiarazione di conformità				
EU declaration of conformity				

EU prohlášení o shodě	2077153	25-02/17		 0.5 MB
EU-overensstemmelseserklæring				
Δήλωση συμμόρφωσης της ΕΕ				
EU-vaatimustenmukaisuusvakuutus				
EU-típusbizonyítvány				
EU-conformiteitsverklaring				
Deklaracja zgodności UE				
Declaração de Conformidade UE				
Declarația de conformitate UE				
EÚ vyhlásenie o zhode				

CAD data

CAD data for this item on TraceParts