

ITEM 085381 TX2B-A024BH10

Description	Technical data	Accessories	Downloads
-------------	----------------	-------------	-----------



Features

- › Auxiliary release on the front
- › With door monitoring contact
- › Plug connector BH10

Approach direction



- › Figure
Horizontal and vertical
Can be adjusted in 90° steps

Solenoid operating voltage

- › AC/DC 24 V +10%, -15%

LED function display

The switch has a function display (2 LEDs, red and green). The LED voltage is same as the solenoid operating voltage.

Guard locking type

TX2 Open-circuit current principle, guard locking by applying voltage to the solenoid. Release by spring force.

Switching element

ETX Slow-action switching contact 2 NC \ominus / 1 NO + 1 NC (door monitoring
B contact)

Auxiliary release

Is used for releasing the guard locking with the aid of a tool. The auxiliary release must be sealed to prevent tampering (for example with sealing lacquer).

Approvals



Mechanical values and environment

Housing material	Die-cast alloy, cathodically dipped
Weight	Net 0,8 kg
Ambient temperature	-20 ... 80 °C
Degree of protection	IP65
Mechanical life	1 x 10 ⁶
Contact material	Silver alloy, gold flashed
Switching principle	Slow-action switching contact
Installation position	Any
Number of door position NC contacts	1 Switches green LED
Number of guard lock monitoring positively driven contacts	2
Number of guard lock monitoring NO contacts	1 Switches red LED
Connection	1 x Plug connector BHA10 [1]
Approach speed	max. 20 m/min
Actuation frequency	1200 1/h

Guard locking principle	Open-circuit current principle
Locking force F_{max}	1700 N
Locking force F_{Zh}	1300 N
Retention force	20 N
Extraction force	35 N
Actuating force	35 N
Insertion depth	min.32 mm

Electrical connection ratings

Rated thermal current I_{th}	4 A [2]
Utilization category according to EN 60947-5-1	AC-15 4A 24V [3] DC-13 4A 24V [4]
Solenoid operating voltage	AC/DC 24 V -15% ... +10%
Short circuit protection according to IEC 60269-1	(Fuse) 4A gG [5]
Rated insulation voltage U_i	50 V
Rated impulse withstand voltage U_{imp}	2,5 kV
Switching voltage	Min. at 10mA 12 V
Switching current	Min. at 24V 1 mA
Power consumption	8 W
Solenoid duty cycle	100 %
LED indicator	Operating voltage corresponds to the solenoid voltage [6]

Reliability values acc. to EN ISO 13849-1

	Monitoring of guard locking and the safety guard position
B10D	6×10^6

in combination with Actuator BETAETIGER-X-GQ, 079740

Mechanical values and environment

Overtravel	1 mm
------------	------

in combination with Actuator BETAETIGER-X-GNQ, 079742, 098082, 097906

Mechanical values and environment

- [1] 9-pin + PE
- [2, 3, 4] > 70°C => 2A
- [5] > 70°C => 2A gG
- [6] 2 LEDs; green, red

Dimension drawing

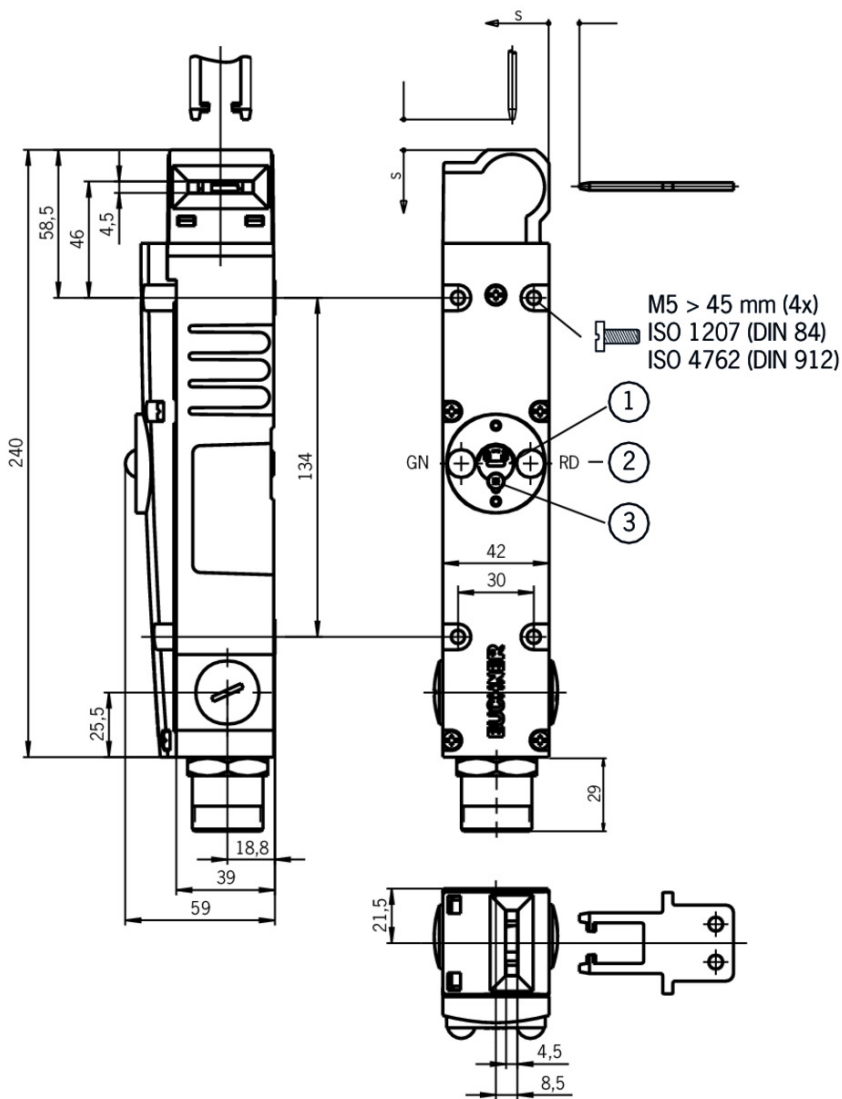

Legende

- 1 Auxiliary release
- 2 LED indicator
- 3 Locking screw

ETX B

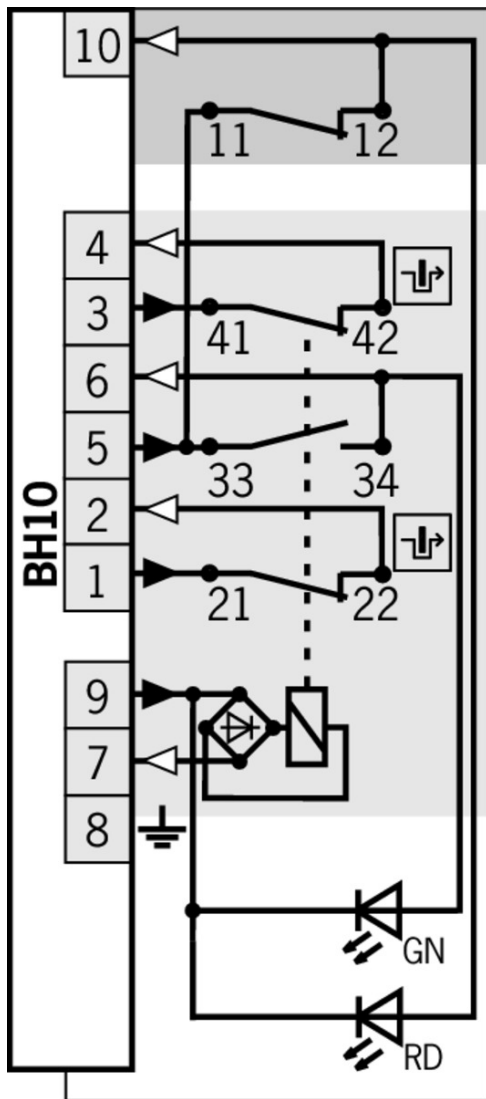

Switching functions

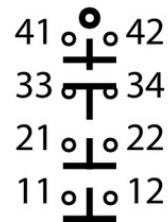
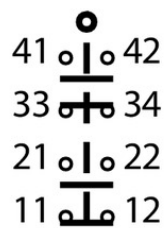
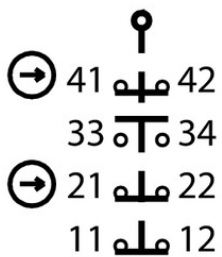
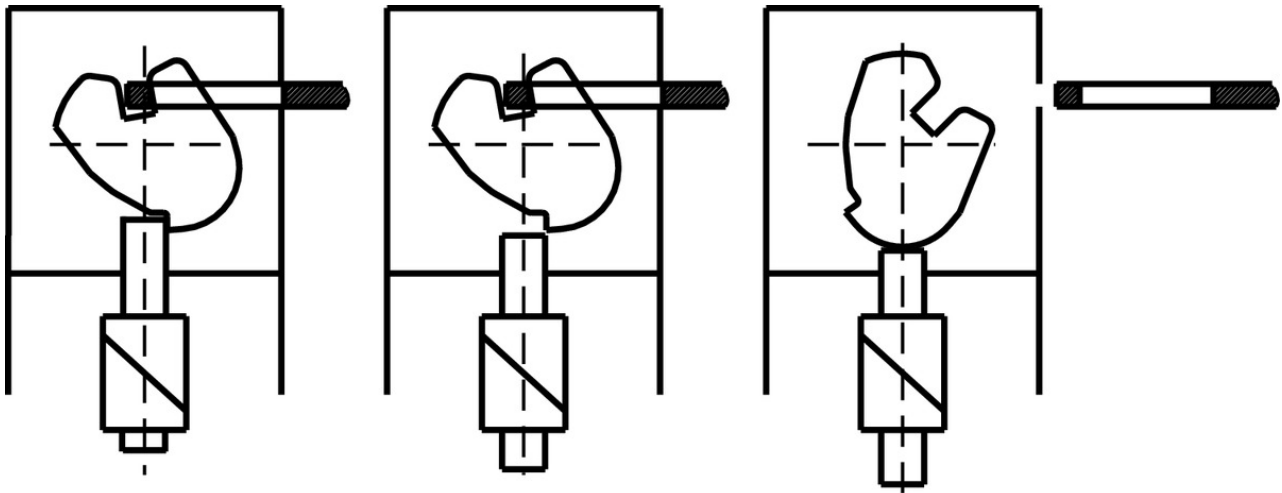

ETX B

Actuator

- Bent actuator for safety switches NX/TX



079740 BETAETIGER-X-WQ

Features

- › Actuators made of stainless steel
- › Two stainless safety screws per actuator
- › With rubber bush

- Actuators for safety switches NX/TX



079739 BETAETIGER-X-GQ

Features

- › Actuators made of stainless steel
- › Two stainless safety screws per actuator
- › With rubber bush

- Bent actuator for safety switches NX/TX, increased overtravel



079742 BETAETIGER-X-WNQ

Features

- › Actuators made of stainless steel
- › Two stainless safety screws per actuator
- › With rubber bush

- ▼ Actuators for safety switches NX/TX, increased overtravel



079741 BETAETIGER-X-GNQ

▼ Features

- › Actuators made of stainless steel
- › Two stainless safety screws per actuator
- › With rubber bush

- ▼ Hinged actuator left/right for safety switches NX/TX



098082 RADIUSBETAETIGER-X-LR-N

▼ Features

- › Actuators made of stainless steel
- › Two stainless safety screws per actuator

- ▼ Hinged actuator top/bottom for safety switches NX/TX



097906 RADIUSBETAETIGER-X-OU-N

▼ Features

- › Actuators made of stainless steel
- › Two stainless safety screws per actuator

Bolt

- ▼ Bolt TX-A for safety switches TX and NX



082990 RIEGEL TX-A

▼ Features

- › Steel bolt
- › For doors hinged on the right
- › Can be locked in open position with padlocks
- › Actuator and switch bracket included

- ▼ Bolt TX-C for safety switches TX and NX



082991 RIEGEL TX-C

▼ Features

- › Steel bolt
- › For doors hinged on the left
- › Can be locked in open position with padlocks
- › Actuator and switch bracket included

Mounting accessories

- ▼ Mounting plates EMP-SB for safety switches CTP, TP...A, STA, STP and TX



093456 EMP-SB

▼ Features

- › For vertical and horizontal mounting of safety switches TP...A, STA, STP and

-
- ▼ Mounting plates EMP-B1 for actuators for safety switches CTP, TP...A, STA, STP, TX and TZ



093457 EMP-B1

-
- ▼ Mounting plates EMP-B2 for actuators for safety switches CTP, TP...A, STA, STP, TX and TZ



093458 EMP-B2

Function expansion

-
- ▼ Lockout mechanism NX/TX



096098 SPERREINSATZ TX

- ▼ Features

- › Prevents unintentional closing of the door
- › Can be secured with padlocks

-
- ▼ Emergency unlocking for safety switches TX



094771 NOTENTSPERRUNG TX

-
- ▼ Release with automatic reset for safety switches TX



094773 ENTRIEGELUNG RUECKSTELLEND TX1/3

-
- ▼ Lock for mechanical release for safety switches TX



079796 SCHLOSS TX VERSCHIEDENSCHLIESSEND



079795 SCHLOSS TX GLEICHSCHLIESSEND





Spare parts

-
- ▼ Lead seal kit

087256 PLOMBENSATZ C1937













Instructions

▼ Betriebsanleitung Sicherheitsschalter TX...

	Doc. no.	Version	Language	Download
Betriebsanleitung Sicherheitsschalter TX...	079777	07-01/17		 4.4 MB
Mode d'emploi pour les interrupteurs de sécurité TX...				
Istruzioni di impiego dei finecorsa di sicurezza TX...				
Operating Instructions Safety Switches TX...				

Catalogs

▼ Sicherheitsschalter mit Metallgehäuse Safety Switches with Metal Housing Bezpečnostní spínače s kovovým pouzdrém Interrupteurs de sécurité avec boîtier métallique 金属壳体 的安全开关 Interruptores de seguridad con carcasa metálica

	Doc. no.	Version	Language	Download
Sicherheitsschalter mit Metallgehäuse	100319	11-03/18		 7.9 MB
Interrupteurs de sécurité avec boîtier métallique	100676	11-03/18		 7.9 MB
Interruptores de seguridad con carcasa metálica	104856	11-03/18		 14.0 MB
Safety Switches with Metal Housing	100369	11-03/18		 7.9 MB
Bezpečnostní spínače s kovovým pouzdrém	121650	11-03/18		 7.9 MB
金属壳体 的安全开关	102453	11-03/18		 8.2 MB

Declaration of conformity

▼ EU prohlášení o shodě

	Doc. no.	Version	Language	Download
EU-Konformitätserklärung Declaración UE de conformidad Déclaration UE de conformité Dichiarazione di conformità EU declaration of conformity	2077153	25-02/17	    	 0.3 MB
EU prohlášení o shodě EU-overensstemmelseserklæring Δήλωση συμμόρφωσης της ΕΕ EU-vaatimustenmukaisuusvakuutus EU-típusbizonyítvány EU-conformiteitsverklaring Deklaracja zgodności UE Declaração de Conformidade UE Declarația de conformitate UE EÚ vyhlásenie o zhode	2077153	25-02/17	        	 0.5 MB

CAD data

CAD data for this item on TraceParts