

ITEM 093559 TX3B-A024RC18C1991

Description	Technical data	Accessories	Downloads
-------------	----------------	-------------	-----------



Features

- › Auxiliary release on the front
- › Escape release on the rear
- › Release under load possible
- › With door monitoring contact
- › Plug connector M23 (RC18)

Approach direction

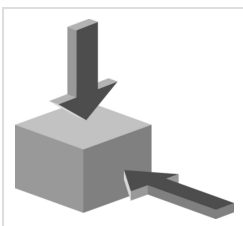

› Figure

Horizontal and vertical
Can be adjusted in 90° steps

Solenoid operating voltage

- › AC/DC 24 V +10%, -15%

LED function display

The switch has a function display (2 LEDs, red and green). The LED voltage is same as the solenoid operating voltage.

Guard locking type

TX3 Closed-circuit current principle, guard locking by spring force. Release by applying voltage to the solenoid. Release under load possible.

Switching element

ETX Slow-action switching contact 2 NC \ominus / 1 NO + 1 NC (door monitoring contact)
B

Auxiliary release

Is used for releasing the guard locking with the aid of a tool. The auxiliary release must be sealed to prevent tampering (for example with sealing lacquer).

Escape release

This is used for manual release of guard locking from within the danger area without tools. With identification of On/Off position.

Approvals



Mechanical values and environment

Housing material	Die-cast alloy, cathodically dipped
Weight	Net 0,8 kg
Ambient temperature	-20 ... 80 °C
Degree of protection	IP65
Mechanical life	1 x 10 ⁶
Contact material	Silver alloy, gold flashed
Switching principle	Slow-action switching contact
Installation position	Any
Number of door position NC contacts	1 [1]
Number of guard lock monitoring positively driven contacts	2
Number of guard lock monitoring NO contacts	1

Connection	1 x Plug connector RC18 [2]
Approach speed	max. 20 m/min
Actuation frequency	1200 1/h
Guard locking principle	Closed-circuit current principle [3]
Locking force F_{max}	1700 N
Locking force F_{Zh}	1300 N
Retention force	min.50 N [4]
Extraction force	35 N
Actuating force	35 N
Insertion depth	min.32 mm

Electrical connection ratings

Rated thermal current I_{th}	4 A [5]
Utilization category according to EN 60947-5-1	AC-15 4A 24V [6] DC-13 4A 24V [7]
Solenoid operating voltage	AC/DC 24 V -15% ... +10%
Short circuit protection according to IEC 60269-1	(Fuse) 4A gG [8]
Rated insulation voltage U_i	50 V
Rated impulse withstand voltage U_{imp}	1,5 kV
Switching voltage	Min. at 10mA 12 V
Switching current	Min. at 24V 1 mA
Power consumption	8 W [9]
Solenoid duty cycle	100 %
LED indicator	Operating voltage corresponds to the solenoid voltage [10]

Miscellaneous

C number	C1991 [11]
----------	------------

Reliability values acc. to EN ISO 13849-1

	Control of the guard locking
Category	Depending on external control of guard locking [12]
Performance Level	Depending on external control of guard locking [13]
PFH _D	Depending on external control of guard locking [14]

	Monitoring of guard locking and the safety guard position
B10D	6×10^6

in combination with Actuator BETAETIGER-X-GQ, 079740

Mechanical values and environment

Overtravel	1 mm
------------	------

in combination with Actuator BETAETIGER-X-GNQ, 079742, 098082, 097906

Mechanical values and environment

Overtravel	8 mm
------------	------

[1, 5, 6, 7] > 70°C => 2A

[2] 18-pin + PE

[3] Unlocking under load

[4] Release under load

[8] > 70°C => 2A gG

[9] At the instant switched on 48W

[10] 2 LEDs; green, red

[11] Escape release with short actuator shaft

[12, 13, 14] LEDs have the same ground potential as the guard locking solenoid.

Dimension drawing

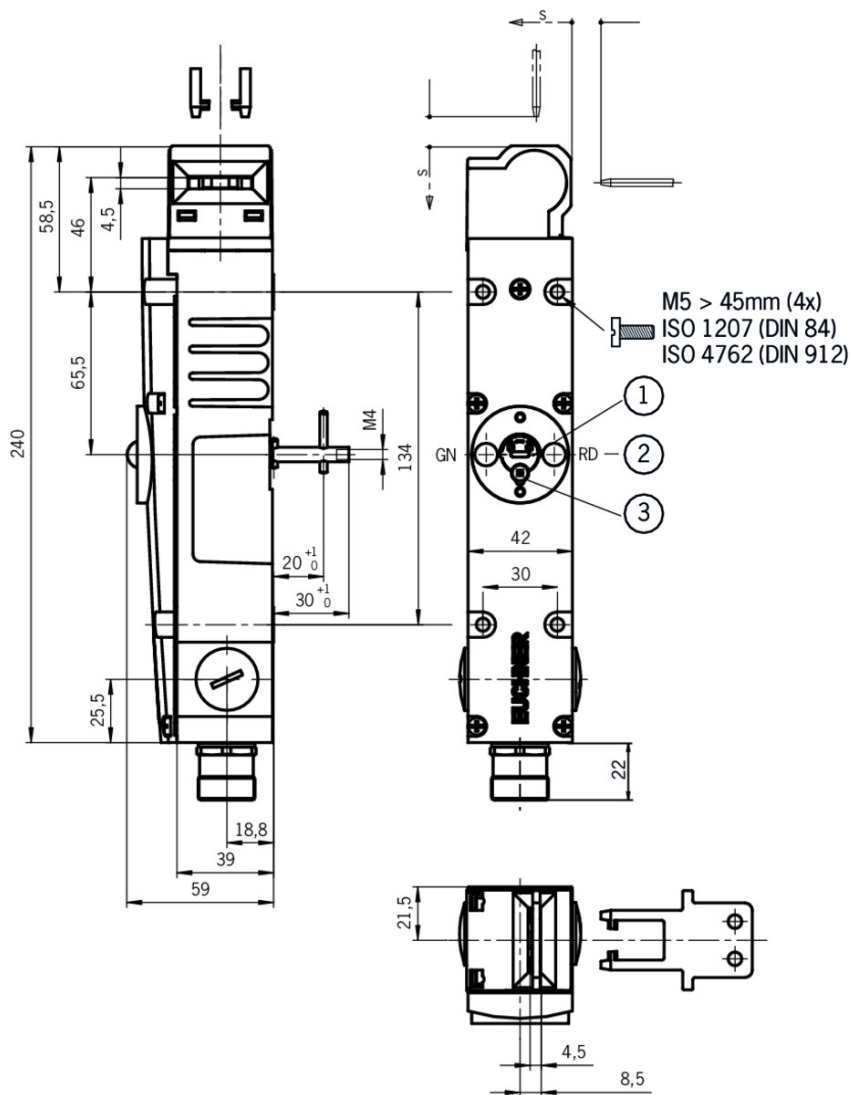

Legende

- 1 Auxiliary release
- 2 LED indicator
- 3 Locking screw

ETX B

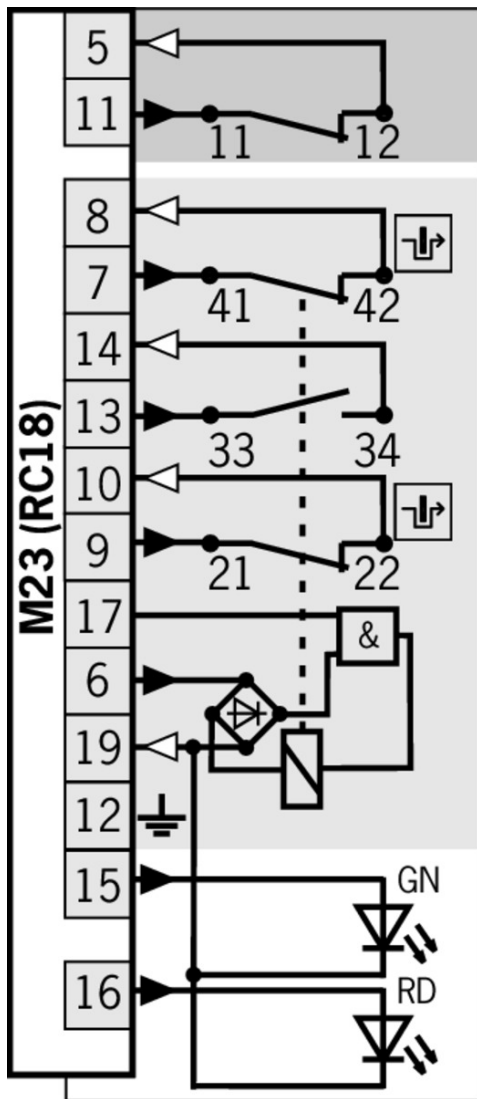

Switching functions

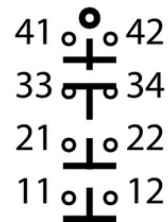
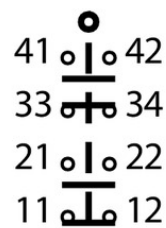
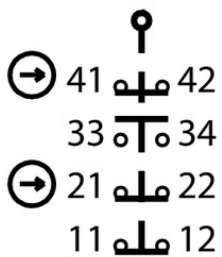
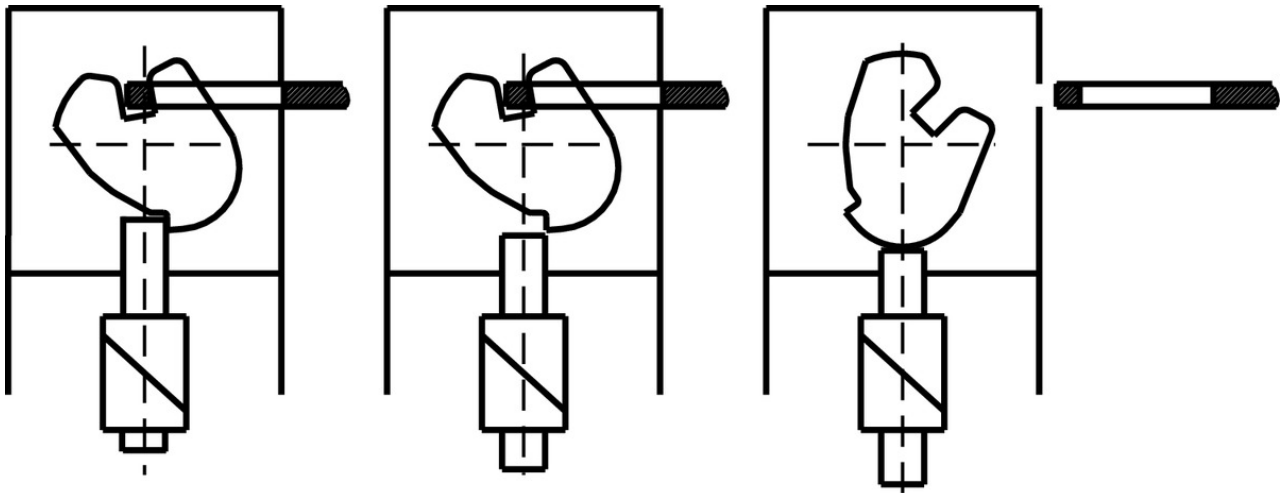

ETX B

Actuator

- Bent actuator for safety switches NX/TX



079740 BETAETIGER-X-WQ

Features

- › Actuators made of stainless steel
- › Two stainless safety screws per actuator
- › With rubber bush

- Actuators for safety switches NX/TX



079739 BETAETIGER-X-GQ

Features

- › Actuators made of stainless steel
- › Two stainless safety screws per actuator
- › With rubber bush

- Actuators for safety switches NX/TX, increased overtravel



079741 BETAETIGER-X-GNQ

Features

- › Actuators made of stainless steel
- › Two stainless safety screws per actuator
- › With rubber bush

- ▼ Bent actuator for safety switches NX/TX, increased overtravel



079742 BETAETIGER-X-WNQ

▼ Features

- › Actuators made of stainless steel
- › Two stainless safety screws per actuator
- › With rubber bush

- ▼ Hinged actuator left/right for safety switches NX/TX



098082 RADIUSBETAETIGER-X-LR-N

▼ Features

- › Actuators made of stainless steel
- › Two stainless safety screws per actuator

- ▼ Hinged actuator top/bottom for safety switches NX/TX



097906 RADIUSBETAETIGER-X-OU-N

▼ Features

- › Actuators made of stainless steel
- › Two stainless safety screws per actuator

Bolt

- ▼ Bolt TX-AF with escape release for safety switches TX...C1991



085392 RIEGEL TX-AF

▼ Features

- › Steel bolt
- › For safety switches with escape release **TX...C1991 + 2161**
- › For doors hinged on the right
- › Detent knob in open position
- › Can be locked in open position with padlocks
- › Actuator and switch bracket included

- ▼ Bolt TX-CF with escape release for safety switches TX...C1991



085393 RIEGEL TX-CF

▼ Features

- › Steel bolt
- › For safety switches with escape release **TX...C1991 + 2161**
- › For doors hinged on the left
- › Detent knob in open position
- › Can be locked in open position with padlocks
- › Actuator and switch bracket included

Function expansion

- ▼ Lock for mechanical release for safety switches TX



079795 SCHLOSS TX GLEICHSCHLIESSEND



079796 SCHLOSS TX VERSCHIEDENSCHLIESSEND

▼ Emergency unlocking for safety switches TX



094771 NOTENTSPERRUNG TX

▼ Release with automatic reset for safety switches TX



094773 ENTRIEGELUNG RUECKSTELLEND TX1/3

▼ Lockout mechanism NX/TX



096098 SPERREINSATZ TX

▼ Features

- › Prevents unintentional closing of the door
 - › Can be secured with padlocks
-

Mounting accessories

▼ Mounting plates EMP-SB for safety switches CTP, TP...A, STA, STP and TX



093456 EMP-SB

▼ Features

- › For vertical and horizontal mounting of safety switches TP...A, STA, STP and TX
-

▼ Mounting plates EMP-B1 for actuators for safety switches CTP, TP...A, STA, STP, TX and TZ



093457 EMP-B1

▼ Mounting plates EMP-B2 for actuators for safety switches CTP, TP...A, STA, STP, TX and TZ



093458 EMP-B2

Spare parts

▼ Lead seal kit

087256 PLOMBENSATZ C1937

Connection material

▼ Female plug RC18 straight



074616 RC18EF

▼ Features

- › Plug connector M23, straight
- › Number of pins: 19-pin with screen bonding clamp

▼ Female plug RC18 angled



074617 RC18WF

▼ Features

- › Plug connector M23, angled
- › Number of pins: 19-pin with screen bonding clamp

▼ Replacement crimp contacts for female connector RC18

094309 CRIMPKONTAKT BUCHSE RCF

▼ Features

- › 19 crimp sockets
- › Conductor cross-section 19 x 0.75 - 1 mm²
- › For plug connector RC18

▼ Female plug RC18 straight with option C1825



077025 RC18EF-C1825

▼ Features

- › Plug connector M23, straight
- › Number of pins: 19-pin with screen bonding clamp

▼ Female connector RC18 angled with option C1825



077026 RC18WF-C1825

▼ Features

- › Plug connector M23, angled
- › Number of pins: 19-pin with screen bonding clamp

▼ Replacement crimp contacts for female connector RC18 with option C1825

094310 CRIMPKONTAKT BUCHSE RCF-C1825

▼ Features

- › 19 crimp sockets
- › Conductor cross-section 16 x 0.25 - 0.5 mm² and 3 x 0.75 - 1 mm²
- › For plug connector RC18..C1825

▼ Connection cable with plug connector M23 with option C1825, 1.5m, straight



092761 C-M23F19-19XDIFPU01,5-MA-092761

▼ Features

- › M23 plug connector, 18-pin + PE
 - › Straight plug connector
 - › PUR cable
 - › Cable length 1.5 m
 - › With flying lead
 - › Cores color-coded
-

▼ Connection cable with plug connector M23 with option C1825, 1.5m, angled



092906 C-M23F19-19XDIFPU01,5-MA-092906

▼ Features

- › M23 plug connector, 18-pin + PE
 - › Angled plug connector
 - › Cable exit C (left)
 - › PUR cable
 - › Cable length 1.5 m
 - › With flying lead
 - › Cores color-coded
-



092907 C-M23F19-19XDIFPU01,5-MA-092907

▼ Features

- › M23 plug connector, 18-pin + PE
 - › Angled plug connector
 - › Cable exit A (right)
 - › PUR cable
 - › Cable length 1.5 m
 - › With flying lead
 - › Cores color-coded
-

▼ Connection cable with plug connector M23 with option C1825, 3m, straight



092816 C-M23F19-19XDIFPU03,0-MA-092816

▼ Features

- › M23 plug connector, 18-pin + PE
 - › Straight plug connector
 - › PUR cable
 - › Cable length 3 m
 - › With flying lead
 - › Cores color-coded
-

▼ Connection cable with plug connector M23 with option C1825, 3m, angled



092908 C-M23F19-19XDIFPU03,0-MA-092908

▼ Features

- › M23 plug connector, 18-pin + PE
- › Angled plug connector
- › Cable exit C (left)
- › PUR cable
- › Cable length 3 m
- › With flying lead
- › Cores color-coded



092909 C-M23F19-19XDIFPU03,0-MA-092909

▼ Features

- › M23 plug connector, 18-pin + PE
- › Angled plug connector
- › Cable exit A (right)
- › PUR cable
- › Cable length 3 m
- › With flying lead
- › Cores color-coded

▼ Connection cable with plug connector M23 with option C1825, 6m, straight



077014 C-M23F19-19XDIFPU06,0-MA-077014

▼ Features

- › M23 plug connector, 18-pin + PE
- › Straight plug connector
- › PUR cable
- › Cable length 6 m
- › With flying lead
- › Cores color-coded

▼ Connection cable with plug connector M23 with option C1825, 6m, angled



077018 C-M23F19-19XDIFPU06,0-MA-077018

▼ Features

- › M23 plug connector, 18-pin + PE
- › Angled plug connector
- › Cable exit C (left)
- › PUR cable
- › Cable length 6 m
- › With flying lead
- › Cores color-coded



085194 C-M23F19-19XDIFPU06,0-MA-085194

▼ Features

- › M23 plug connector, 18-pin + PE
- › Angled plug connector
- › Cable exit A (right)
- › PUR cable
- › Cable length 6 m
- › With flying lead
- › Cores color-coded

▼ Connection cable with plug connector M23 with option C1825, 8m, straight



077015 C-M23F19-19XDIFPU08,0-MA-077015

▼ Features

- › M23 plug connector, 18-pin + PE
- › Straight plug connector
- › PUR cable
- › Cable length 8 m
- › With flying lead

- › Cores color-coded
-

▼ Connection cable with plug connector M23 with option C1825, 8m, angled



077019 C-M23F19-19XDIFPU08,0-MA-077019

▼ Features

- › RC18 plug connector, 18-pin + PE
 - › Angled plug connector
 - › Cable exit C (left)
 - › PUR cable
 - › Cable length 8 m
 - › With flying lead
 - › Cores color-coded
-



085195 C-M23F19-19XDIFPU08,0-MA-085195

▼ Features

- › M23 plug connector, 18-pin + PE
 - › Angled plug connector
 - › Cable exit A (right)
 - › PUR cable
 - › Cable length 8 m
 - › With flying lead
 - › Cores color-coded
-

▼ Connection cable with plug connector M23 with option C1825, 10m, straight



092898 C-M23F19-19XDIFPU10,0-MA-092898

▼ Features

- › M23 plug connector, 18-pin + PE
 - › Straight plug connector
 - › PUR cable
 - › Cable length 10 m
 - › With flying lead
 - › Cores color-coded
-

▼ Connection cable with plug connector M23 with option C1825, 10m, angled



092901 C-M23F19-19XDIFPU10,0-MA-092901

▼ Features

- › M23 plug connector, 18-pin + PE
 - › Angled plug connector
 - › Cable exit C (left)
 - › PUR cable
 - › Cable length 10 m
 - › With flying lead
 - › Cores color-coded
-



092902 C-M23F19-19XDIFPU10,0-MA-092902

▼ Features

- › M23 plug connector, 18-pin + PE
- › Angled plug connector
- › Cable exit A (right)
- › PUR cable

- › Cable length 10 m
 - › With flying lead
 - › Cores color-coded
-

☑ Connection cable with plug connector M23 with option C1825, 15m, straight



077016 C-M23F19-19XDIFPU15,0-MA-077016

☑ Features

- › M23 plug connector, 18-pin + PE
 - › Straight plug connector
 - › PUR cable
 - › Cable length 15 m
 - › With flying lead
 - › Cores color-coded
-

☑ Connection cable with plug connector M23 with option C1825, 15m, angled



077020 C-M23F19-19XDIFPU15,0-MA-077020

☑ Features

- › M23 plug connector, 18-pin + PE
 - › Angled plug connector
 - › Cable exit C (left)
 - › PUR cable
 - › Cable length 15 m
 - › With flying lead
 - › Cores color-coded
-



085196 C-M23F19-19XDIFPU15,0-MA-085196

☑ Features

- › M23 plug connector, 18-pin + PE
 - › Angled plug connector
 - › Cable exit A (right)
 - › PUR cable
 - › Cable length 15 m
 - › With flying lead
 - › Cores color-coded
-

☑ Connection cable with plug connector M23 with option C1825, 20m, straight



092726 C-M23F19-19XDIFPU20,0-MA-092726

☑ Features

- › M23 plug connector, 18-pin + PE
 - › Straight plug connector
 - › PUR cable
 - › Cable length 20 m
 - › With flying lead
 - › Cores color-coded
-

☑ Connection cable with plug connector M23 with option C1825, 20m, angled



092910 C-M23F19-19XDIFPU20,0-MA-092910

☑ Features

- › M23 plug connector, 18-pin + PE
- › Angled plug connector
- › Cable exit C (left)
- › PUR cable
- › Cable length 20 m
- › With flying lead
- › Cores color-coded



092911 C-M23F19-19XDIFPU20,0-MA-092911

▣ Features

- › M23 plug connector, 18-pin + PE
- › Angled plug connector
- › Cable exit A (right)
- › PUR cable
- › Cable length 20 m
- › With flying lead
- › Cores color-coded

- ▣ Connection cable with plug connector M23 with option C1825, 25m, straight



092727 C-M23F19-19XDIFPU25,0-MA-092727

▣ Features

- › M23 plug connector, 18-pin + PE
- › Straight plug connector
- › PUR cable
- › Cable length 25 m
- › With flying lead
- › Cores color-coded

- ▣ Connection cable with plug connector M23 with option C1825, 25m, angled



092912 C-M23F19-19XDIFPU25,0-MA-092912

▣ Features

- › M23 plug connector, 18-pin + PE
- › Angled plug connector
- › Cable exit C (left)
- › PUR cable
- › Cable length 25 m
- › With flying lead
- › Cores color-coded



092913 C-M23F19-19XDIFPU25,0-MA-092913

▣ Features

- › M23 plug connector, 18-pin + PE
- › Angled plug connector
- › Cable exit A (right)
- › PUR cable
- › Cable length 25 m
- › With flying lead
- › Cores color-coded

- ▣ Connection cable with plug connector M23 with option C1825, 30m, straight



095993 C-M23F19-19XDIFPU30,0-MA-095993

▼ Features

- › M23 plug connector, 18-pin + PE
 - › Straight plug connector
 - › PUR cable
 - › Cable length 30 m
 - › With flying lead
 - › Cores color-coded
-

▼ Connection cable with plug connector M23 with option C1825, 40m, straight



102490 C-M23F19-19XDIFPU40,0-MA-102490

▼ Features

- › M23 plug connector, 18-pin + PE
 - › Straight plug connector
 - › PUR cable
 - › Cable length 40 m
 - › With flying lead
 - › Cores color-coded
-

▼ Connection cable with plug connector M23, 19-pin, 1.5m, straight



110301 C-M23F19-19XDIFPU01,5-MA-110301

▼ Features

- › M23 female plug, 19-pin
 - › Straight plug connector
 - › PUR cable
 - › Cable length 1.5 m
 - › With flying lead
 - › Cores numbered, black
-

▼ Connection cable with plug connector M23, 19-pin, 3m, straight



110302 C-M23F19-19XDIFPU03,0-MA-110302

▼ Features

- › M23 female plug, 19-pin
 - › Straight plug connector
 - › PUR cable
 - › Cable length 3 m
 - › With flying lead
 - › Cores numbered, black
-

▼ Connection cable with plug connector M23, 19-pin, 6m, straight



110303 C-M23F19-19XDIFPU06,0-MA-110303

▼ Features

- › M23 female plug, 19-pin
 - › Straight plug connector
 - › PUR cable
 - › Cable length 6 m
 - › With flying lead
 - › Cores numbered, black
-

- ▼ Connection cable with plug connector M23, 19-pin, 10m, straight



110304 C-M23F19-19XDIFPU10,0-MA-110304

▼ Features

- › M23 female plug, 19-pin
 - › Straight plug connector
 - › PUR cable
 - › Cable length 10 m
 - › With flying lead
 - › Cores numbered, black
-

- ▼ Connection cable with plug connector M23, 19-pin, 15m, straight



110305 C-M23F19-19XDIFPU15,0-MA-110305

▼ Features

- › M23 female plug, 19-pin
 - › Straight plug connector
 - › PUR cable
 - › Cable length 15 m
 - › With flying lead
 - › Cores numbered, black
-

- ▼ Connection cable with plug connector M23, 19-pin, 20m, straight



110306 C-M23F19-19XDIFPU20,0-MA-110306

▼ Features

- › M23 female plug, 19-pin
 - › Straight plug connector
 - › PUR cable
 - › Cable length 20 m
 - › With flying lead
 - › Cores numbered, black
-

- ▼ Connection cable with plug connector M23, 19-pin, 25m, straight



110307 C-M23F19-19XDIFPU25,0-MA-110307

▼ Features

- › M23 female plug, 19-pin
 - › Straight plug connector
 - › PUR cable
 - › Cable length 25 m
 - › With flying lead
 - › Cores numbered, black
-

Instructions

- ▼ Betriebsanleitung Sicherheitsschalter TX...

	Doc. no.	Version	Language	Download
Betriebsanleitung Sicherheitsschalter TX...	079777	07-01/17		4.4 MB
Mode d'emploi pour les interrupteurs de sécurité TX...				
Istruzioni di impiego dei finecorsa di sicurezza TX...				
Operating Instructions Safety Switches TX...				

Catalogs

- Sicherheitsschalter mit Metallgehäuse Safety Switches with Metal Housing Bezpečnostní spínače s kovovým pouzdem Interrupteurs de sécurité avec boîtier métallique 金属壳体 的安全开关 Interruptores de seguridad con carcasa metálica

	Doc. no.	Version	Language	Download
Sicherheitsschalter mit Metallgehäuse	100319	11-03/18		7.9 MB
Interrupteurs de sécurité avec boîtier métallique	100676	11-03/18		7.9 MB
Interruptores de seguridad con carcasa metálica	104856	11-03/18		14.0 MB
Safety Switches with Metal Housing	100369	11-03/18		7.9 MB
Bezpečnostní spínače s kovovým pouzdem	121650	11-03/18		7.9 MB
金属壳体 的安全开关	102453	11-03/18		8.2 MB

Declaration of conformity

- EU prohlášení o shodě

	Doc. no.	Version	Language	Download
EU-Konformitätserklärung Declaración UE de conformidad Déclaration UE de conformité Dichiarazione di conformità EU declaration of conformity	2077153	25-02/17	 	0.3 MB
EU prohlášení o shodě EU-overensstemmelseserklæring Δήλωση συμμόρφωσης της ΕΕ EU-vaatimustenmukaisuusvakuutus EU-típusbizonyítvány EU-conformiteitsverklaring Deklaracja zgodności UE Declaração de Conformidade UE Declarația de conformitate UE EÚ vyhlásenie o zhode	2077153	25-02/17	 	0.5 MB

CAD data

CAD data for this item on TraceParts