

ITEM 085382 TX1B-A110N

Description	Technical data	Accessories	Downloads
-------------	----------------	-------------	-----------



Features

- › Auxiliary release on the front
- › With door monitoring contact

Approach direction

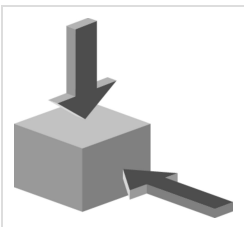

- › Figure
Horizontal and vertical
Can be adjusted in 90° steps

Solenoid operating voltage

- › AC 110 V +10%, -15%

LED function display

The switch has a function display (2 LEDs, red and green). The LED voltage is same as the solenoid operating voltage.

Guard locking type

TX1 Closed-circuit current principle, guard locking by spring force. Release by applying voltage to the solenoid.

Switching element

ETX Slow-action switching contact 2 NC \ominus / 1 NO + 1 NC (door monitoring contact)
B

Auxiliary release

Is used for releasing the guard locking with the aid of a tool. The auxiliary release must be sealed to prevent tampering (for example with sealing lacquer).

Approvals



Mechanical values and environment

Housing material	Die-cast alloy, cathodically dipped
Weight	Net 0,8 kg
Ambient temperature	-20 ... 80 °C
Degree of protection	IP67
Mechanical life	1 x 10 ⁶
Contact material	Silver alloy, gold flashed
Switching principle	Slow-action switching contact
Installation position	Any
Number of door position NC contacts	1
Number of guard lock monitoring positively driven contacts	2
Number of guard lock monitoring NO contacts	1
Connection	3 x NPT 1/2 "
Approach speed	max. 20 m/min
Actuation frequency	1200 1/h
Guard locking principle	Closed-circuit current principle
Locking force F _{max}	1700 N

Locking force F_{Zh}	1300 N
Retention force	20 N
Extraction force	35 N
Actuating force	35 N
Insertion depth	min.32 mm

Electrical connection ratings

Rated thermal current I_{th}	4 A
Utilization category according to EN 60947-5-1	AC-15 4A 230V DC-13 4A 24V
Solenoid operating voltage	AC 110 V -15% ... +10%
Short circuit protection according to IEC 60269-1	(Fuse) 4A gG
Rated insulation voltage U_i	250 V
Rated impulse withstand voltage U_{imp}	2,5 kV
Switching voltage	Min. at 10mA 12 V
Switching current	Min. at 24V 1 mA
Power consumption	10 W
Solenoid duty cycle	100 %
Connection cross-section	0,34 ... 1,5 mm ²
LED indicator	Operating voltage corresponds to the solenoid voltage ^[1]

Reliability values acc. to EN ISO 13849-1

	Control of the guard locking
Category	Depending on external control of guard locking ^[2]
Performance Level	Depending on external control of guard locking ^[3]
PFH _D	Depending on external control of guard locking ^[4]
	Monitoring of guard locking and the safety guard position
B10 _D	6×10^6

in combination with Actuator BETAETIGER-X-GQ, 079740

Mechanical values and environment

Overtravel	1 mm
------------	------

in combination with Actuator BETAETIGER-X-GNQ, 079742, 098082, 097906

Mechanical values and environment

Overtravel

8 mm

[1] 2 LEDs; green, red

[2, 3, 4] LEDs have the same ground potential as the guard locking solenoid.

Dimension drawing

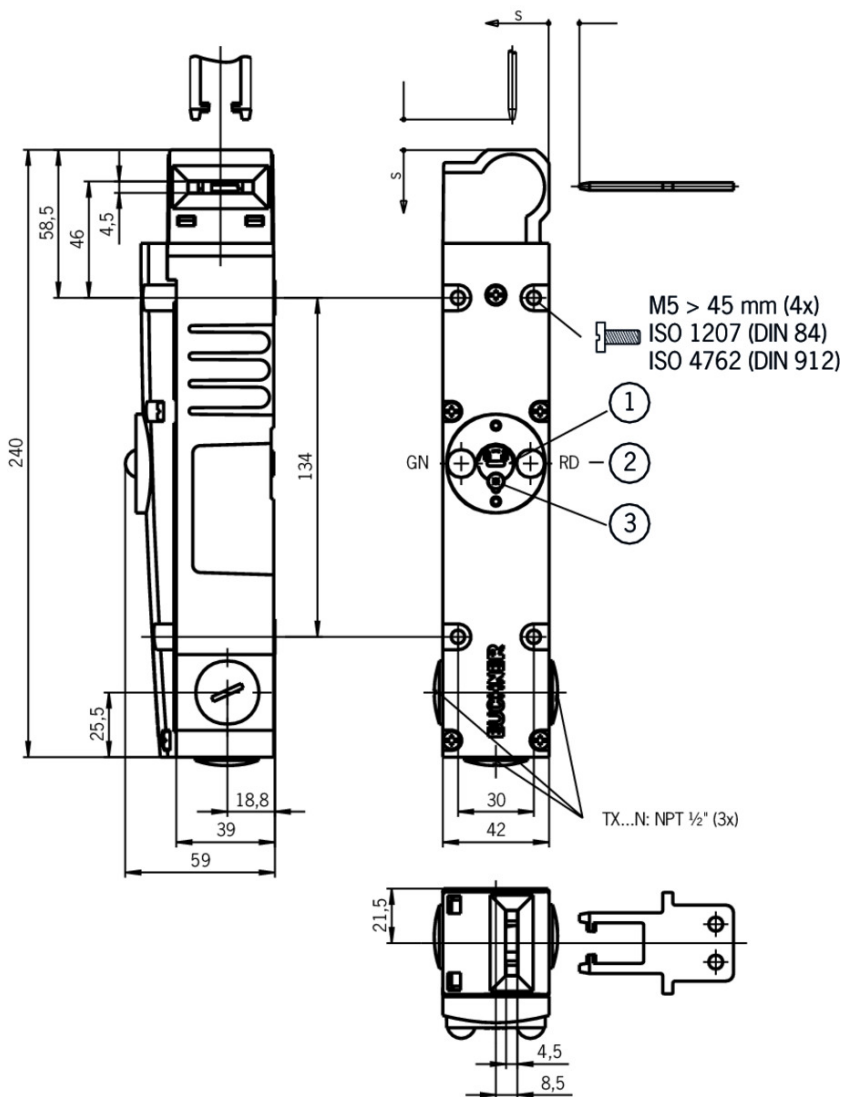

Legende

- 1 Auxiliary release
- 2 LED indicator
- 3 Locking screw

ETX B

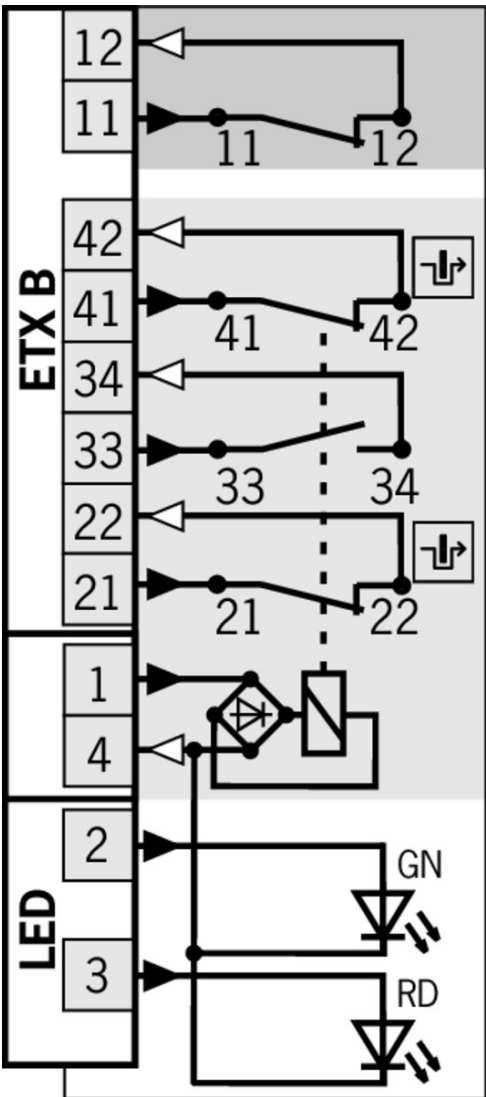

Switching functions

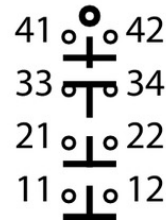
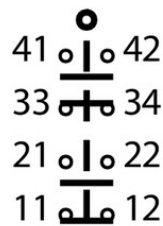
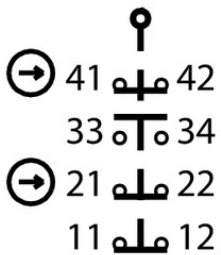
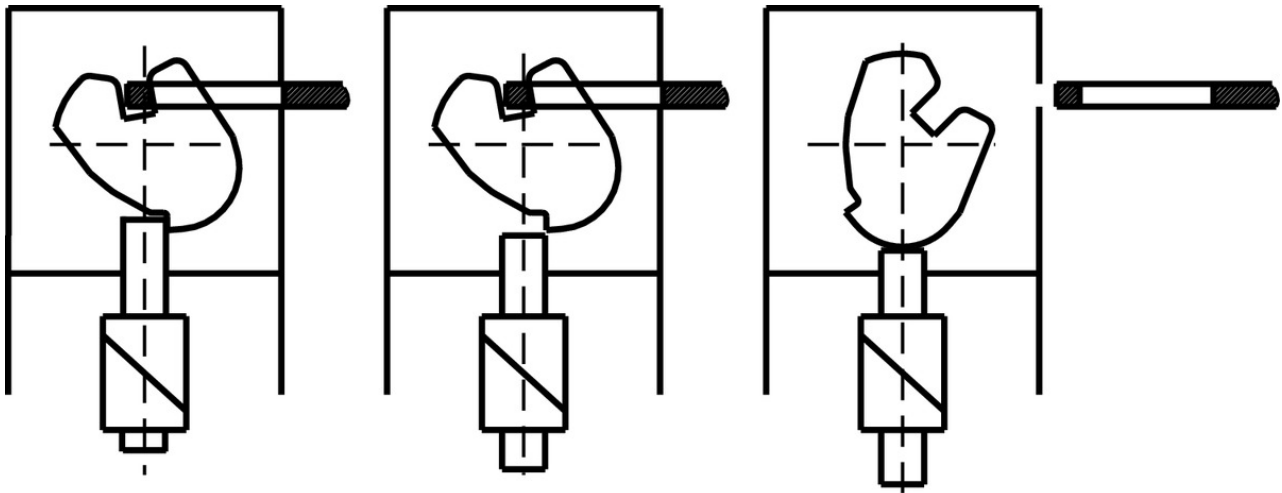

ETX B

Actuator

- ▼ Bent actuator for safety switches NX/TX



079740 BETAETIGER-X-WQ

▼ Features

- › Actuators made of stainless steel
- › Two stainless safety screws per actuator
- › With rubber bush

- ▼ Hinged actuator left/right for safety switches NX/TX



098082 RADIUSBETAETIGER-X-LR-N

▼ Features

- › Actuators made of stainless steel
- › Two stainless safety screws per actuator

- ▼ Bent actuator for safety switches NX/TX, increased overtravel



079742 BETAETIGER-X-WNQ

▼ Features

- › Actuators made of stainless steel
- › Two stainless safety screws per actuator
- › With rubber bush

- ▼ Actuators for safety switches NX/TX, increased overtravel



079741 BETAETIGER-X-GNQ

▼ Features

- › Actuators made of stainless steel
- › Two stainless safety screws per actuator
- › With rubber bush

- ▼ Actuators for safety switches NX/TX



079739 BETAETIGER-X-GQ

▼ Features

- › Actuators made of stainless steel
- › Two stainless safety screws per actuator
- › With rubber bush

- ▼ Hinged actuator top/bottom for safety switches NX/TX



097906 RADIUSBETAETIGER-X-OU-N

▼ Features

- › Actuators made of stainless steel
- › Two stainless safety screws per actuator

Connection material

- ▼ Cable glands NPT ½"



077691 EKVN12/06

Function expansion

- ▼ Emergency unlocking for safety switches TX



094771 NOTENTSPERRUNG TX

- ▼ Lockout mechanism NX/TX



096098 SPERREINSATZ TX

▼ Features

- › Prevents unintentional closing of the door
- › Can be secured with padlocks

- ▼ Lock for mechanical release for safety switches TX



079796 SCHLOSS TX VERSCHIEDENSCHLIESSEND



079795 SCHLOSS TX GLEICHSCHLIESSEND

- ✓ Release with automatic reset for safety switches TX



094773 ENTRIEGELUNG RUECKSTELLEND TX1/3

Mounting accessories

- ✓ Mounting plates EMP-B1 for actuators for safety switches CTP, TP...A, STA, STP, TX and TZ



093457 EMP-B1

- ✓ Mounting plates EMP-SB for safety switches CTP, TP...A, STA, STP and TX



093456 EMP-SB

✓ Features

- › For vertical and horizontal mounting of safety switches TP...A, STA, STP and TX

- ✓ Mounting plates EMP-B2 for actuators for safety switches CTP, TP...A, STA, STP, TX and TZ



093458 EMP-B2

Bolt

- ✓ Bolt TX-A for safety switches TX and NX



082990 RIEGEL TX-A

✓ Features

- › Steel bolt
- › For doors hinged on the right
- › Can be locked in open position with padlocks
- › Actuator and switch bracket included

- ✓ Bolt TX-C for safety switches TX and NX



082991 RIEGEL TX-C

✓ Features

- › Steel bolt
- › For doors hinged on the left
- › Can be locked in open position with padlocks
- › Actuator and switch bracket included





Spare parts

Lead seal kit

087256 PLOMBENSATZ C1937

Instructions

Betriebsanleitung Sicherheitsschalter TX...

	Doc. no.	Version	Language	Download
Betriebsanleitung Sicherheitsschalter TX...	079777	07-01/17		 4.4 MB
Mode d'emploi pour les interrupteurs de sécurité TX...				
Istruzioni di impiego dei finecorsa di sicurezza TX...				
Operating Instructions Safety Switches TX...				

Declaration of conformity

EU prohlášení o shodě

	Doc. no.	Version	Language	Download
EU-Konformitätserklärung	2077153	25-02/17		 0.3 MB
Declaración UE de conformidad				
Déclaration UE de conformité				
Dichiarazione di conformità				
EU declaration of conformity				
EU prohlášení o shodě	2077153	25-02/17		 0.5 MB
EU-overensstemmelseserklæring				
Δήλωση συμμόρφωσης της ΕΕ				
EU-vaatimustenmukaisuusvakuutus				
EU-típusbizonyítvány				
EU-conformiteitsverklaring				
Deklaracja zgodności UE				
Declaração de Conformidade UE				
Declarația de conformitate UE				
EÚ vyhlásenie o zhode				

CAD data

CAD data for this item on TraceParts