

ITEM 084585 CMS-R-AXF-03V

Description	Technical data	Accessories	Downloads
-------------	----------------	-------------	-----------

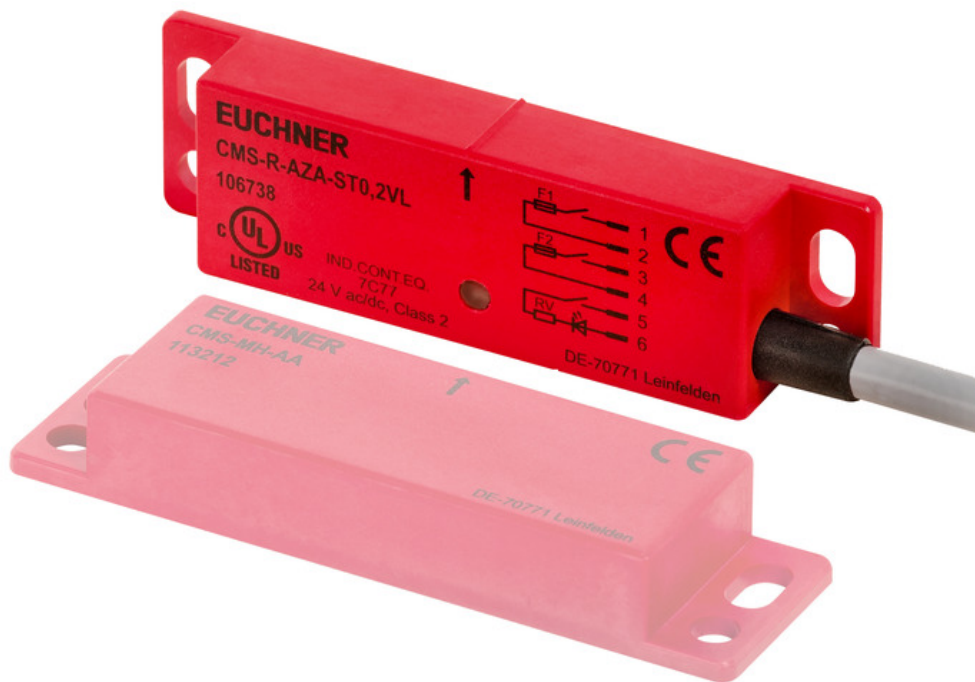

Features

- › In combination with evaluation unit CMS-E-AR
- › Cube-shaped version 88 x 25 mm
- › Connection cable
- › Cable type: PVC

Alignment of read head and actuator

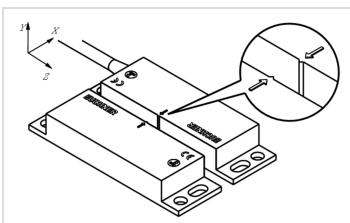

› Figure

Operating diagram, design A

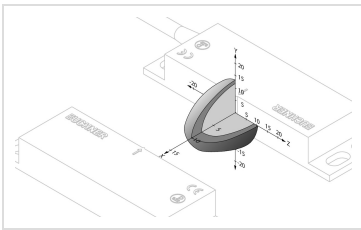

➤ CMS-R-AXF

Typ. switch-on distance

Typ. switch-off distance

Approvals



Mechanical values and environment

Design	A
Material	
	Cable material PVC
Housing material	Fiber glass reinforced PPS
Weight	
	Net 0,17 kg
Ambient temperature	-20 ... 60 °C
Degree of protection	IP67
Resilience to vibration	In acc. with EN 60947-5-2
Mechanical life	100 x 10 ⁶
Installation position	Any, pay attention to marking [1]
Tightening torque	0,4 ... 0,5 Nm
Number of NO contacts	3 NO contact
Connection	Hard-wired encapsulated cable with cable end sleeves 0.75 mm ²
Cable length	3 m
Method of operation	Magnetic, reed contact

Electrical connection ratings

Rated insulation voltage U _i	26,4 V DC
Rated impulse withstand voltage U _{imp}	1,5 kV
Switching voltage	DC 24 V
Switching current	8 ... 500 mA
Degree of contamination (external, according to EN 60947-1)	2
Switching characteristics	Parallel
Switching voltage according to UL	
According to UL Class 2	DCmax.24 V

Operating distance

Repeat accuracy R

max.10 %

Miscellaneous

in compliance with

EN ISO 13849-1:2015; EN 50178:1997; EN 60204-1:2006/A1:2009; EN ISO 14119:2013; EN 61000-6-2:2005; EN 61000-6-3:2007/A1:2011; EN 60947-5-3:2013

[1] During mounting it is to be ensured the marking arrows on actuator and read head are opposite each other.

Dimension drawing

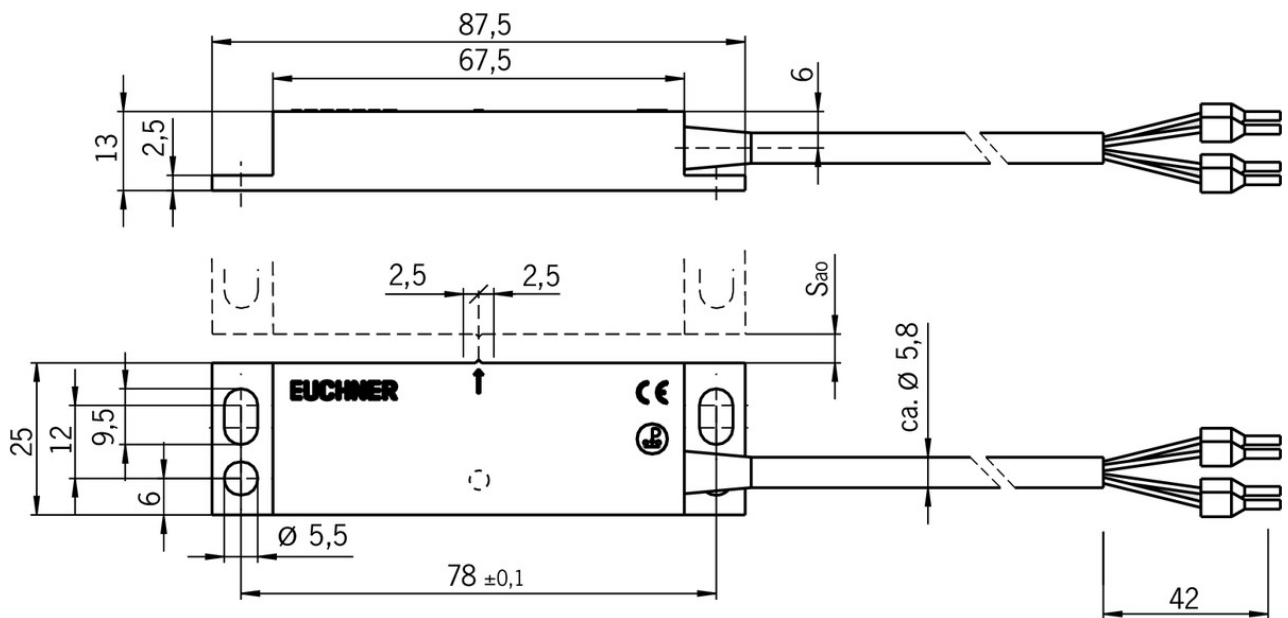

BN

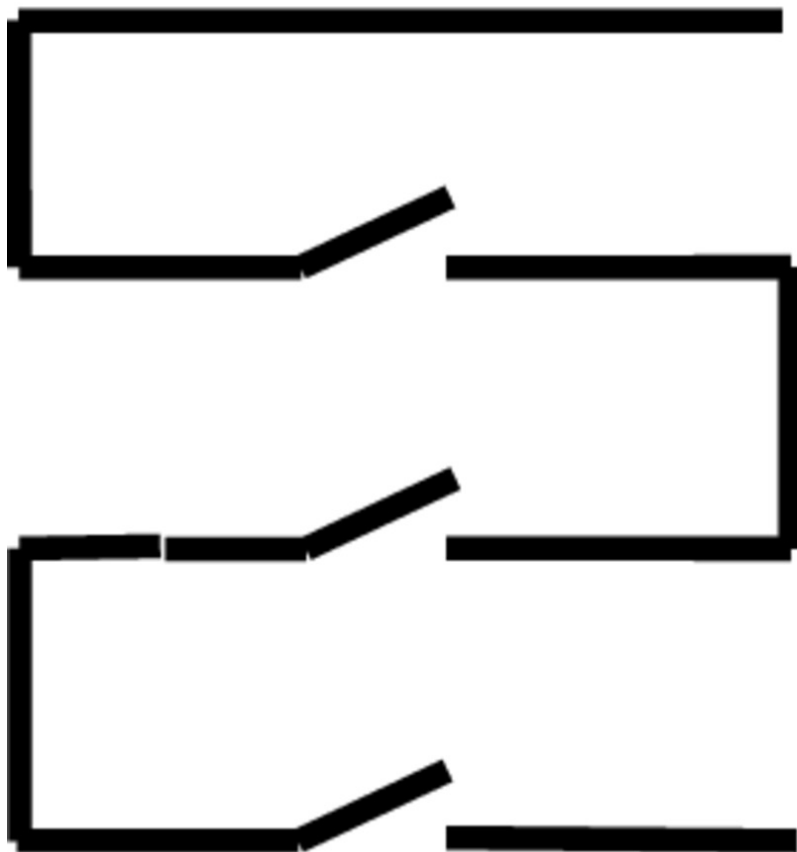

WH

Actuator

Actuator CMS design A



084591 CMS-M-AB

Features

- › Cube-shaped version 88 x 25 mm



085654 CMS-M-AG

Features

- › Cube-shaped version 88 x 25 mm







093976 CMS-M-AI

Features

- › Cube-shaped version 88 x 25 mm







Instructions

☑ Betriebsanleitung Leseköpfe/Betätiger für Auswertegeräte CMS

	Doc. no.	Version	Language	Download
Betriebsanleitung Leseköpfe/Betätiger für Auswertegeräte CMS	2085673	15-04/18		 1.8 MB
Operating Instructions Read Heads/Actuators for Evaluation Units CMS				
Manual de instrucciones de cabezas de lectura/actuadores para unidades de evaluación CMS				
Mode d'emploi des têtes de lecture/actionneurs pour analyseurs CMS				

Catalogs

☑ Magnetisch codierte Sicherheitsschalter CMS Système de sécurité sans contact CMS Magnetically Coded Safety Switches CMS

	Doc. no.	Version	Language	Download
Magnetisch codierte Sicherheitsschalter CMS	086823	09-02/18		 2.3 MB
Système de sécurité sans contact CMS	090606	09-02/18		 2.3 MB
Magnetically Coded Safety Switches CMS	086824	09-02/18		 2.3 MB

CAD data

CAD data for this item on TraceParts