

## ITEM 085740 CMS-R-CXB-05V

Description	Technical data	Accessories	Downloads
-------------	----------------	-------------	-----------



### Features

- › In combination with evaluation units CMS-E-AR
- › Cylindrical version M25
- › Connection cable
- › Cable type: PVC

### Alignment of read head and actuator

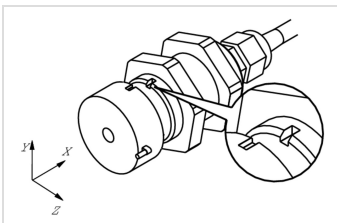

› Figure

### Operating diagram, design C

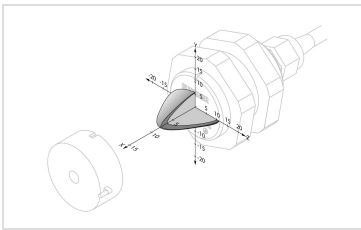

► CMS-R-CXB

Typ. switch-on distance

Typ. switch-off distance

## Approvals



## Mechanical values and environment

Design	C
Material	
Cable material	PVC
Housing material	Fiber glass reinforced PPS
Weight	
Net	0,28 kg
Ambient temperature	-20 ... 60 °C
Degree of protection	IP67
Resilience to vibration	In acc. with EN 60947-5-2
Mechanical life	100 x 10 <sup>6</sup>
Installation position	Any, pay attention to marking <sup>[1]</sup>
Tightening torque	0,4 ... 0,5 Nm
Number of NO contacts	3 NO contact
Connection	Hard-wired encapsulated cable with cable end sleeves 0.75 mm <sup>2</sup>
Cable length	5 m
Method of operation	Magnetic, reed contact

## Electrical connection ratings

Rated insulation voltage U <sub>i</sub>	26,4 V DC
Rated impulse withstand voltage U <sub>imp</sub>	1,5 kV
Switching voltage	DC 24 V
Switching current	8 ... 500 mA
Degree of contamination (external, according to EN 60947-1)	2
Switching characteristics	In series
Switching voltage according to UL	
According to UL Class 2	DCmax.24 V

## Operating distance

Repeat accuracy R

max.10 %

## Miscellaneous

in compliance with

EN ISO 13849-1:2015; EN 50178:1997; EN 60204-1:2006/A1:2009; EN ISO 14119:2013; EN 61000-6-2:2005; EN 61000-6-3:2007/A1:2011; EN 60947-5-3:2013

[1] During mounting it is to be ensured the marking arrows on actuator and read head are opposite each other.

## Dimension drawing

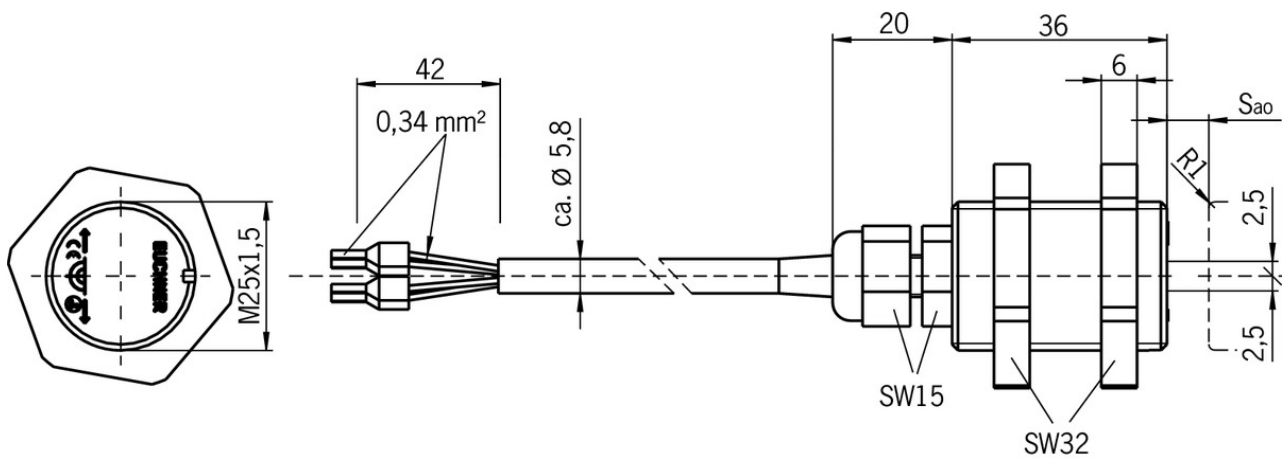

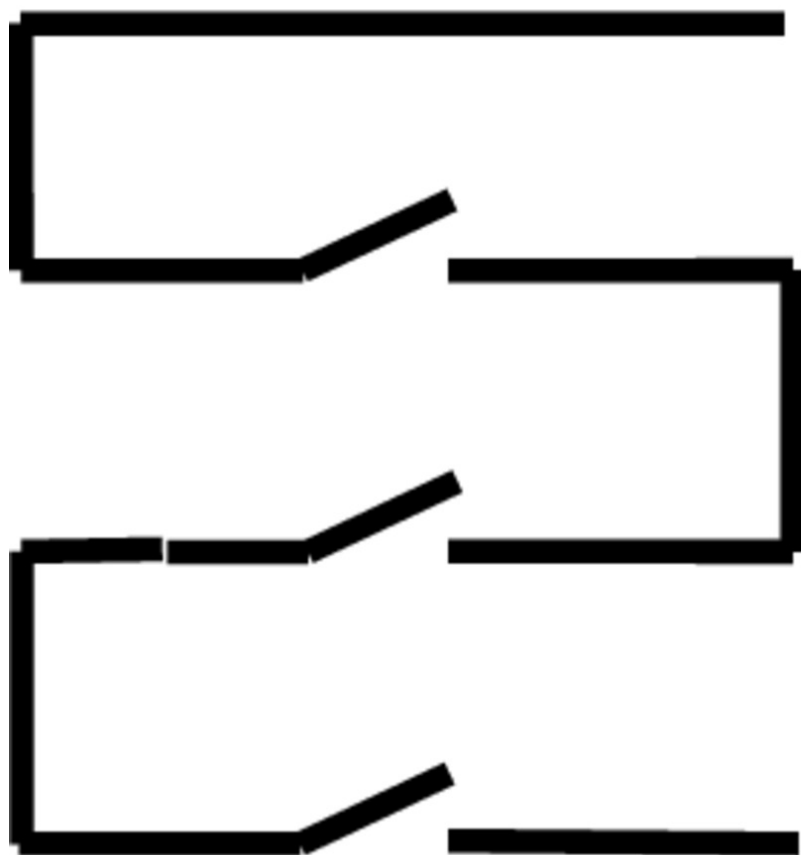

BN

WH

## Actuator

- Actuator CMS design C



**084577** CMS-M-CA





- Features

- › Cylindrical version M25

## Instructions







- Betriebsanleitung Leseköpfe/Betätiger für Auswertegeräte CMS

Doc. no.   Version   Language   Download

Betriebsanleitung Leseköpfe/Betätiger für Auswertegeräte CMS	2085673	15-04/18	   	 1.8 MB
Operating Instructions Read Heads/Actuators for Evaluation Units CMS				
Manual de instrucciones de cabezas de lectura/actuadores para unidades de evaluación CMS				
Mode d'emploi des têtes de lecture/actionneurs pour analyseurs CMS				

## Catalogs

- Magnetisch codierte Sicherheitsschalter CMS Système de sécurité sans contact CMS  
Magnetically Coded Safety Switches CMS

	Doc. no.	Version	Language	Download
Magnetisch codierte Sicherheitsschalter CMS	086823	09-02/18		 2.3 MB
Système de sécurité sans contact CMS	090606	09-02/18		 2.3 MB
Magnetically Coded Safety Switches CMS	086824	09-02/18		 2.3 MB

## CAD data

CAD data for this item on TraceParts