

**ITEM 100755 CMS-R-BXO-SC**

Description	Technical data	Accessories	Downloads
-------------	----------------	-------------	-----------



**Features**

- › In combination with evaluation unit CMS-E-AR
- › Cube-shaped version 36 x 26 mm
- › Plug connector M8

**Alignment of read head and actuator**

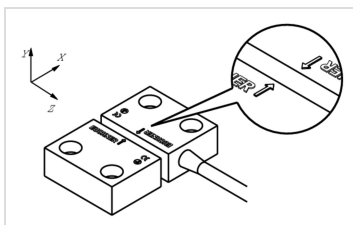

› Figure

**Operating diagram, design B**

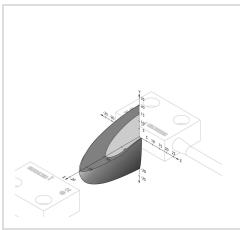

► CMS-R-BXO

Typ. switch-on distance

Typ. switch-off distance

## Approvals



## Mechanical values and environment

Design	B
Housing material	Fiber glass reinforced PPS
Weight	
	Net 0,016 kg
Ambient temperature	-20 ... 60 °C
Degree of protection	IP67
Resilience to vibration	In acc. with EN 60947-5-2
Mechanical life	100 x 10 <sup>6</sup>
Installation position	Any, pay attention to marking <b>[1]</b>
Tightening torque	0,4 ... 0,5 Nm
Number of NO contacts	3 NO contact
Connection	4-pin M8 plug connector
Method of operation	Magnetic, reed contact

## Electrical connection ratings

Rated insulation voltage $U_i$	26,4 V DC
Rated impulse withstand voltage $U_{imp}$	1,5 kV
Switching voltage	DC 24 V
Switching current	8 ... 500 mA
Switching characteristics	Parallel
Switching voltage according to UL	
According to UL Class 2	DCmax.24 V

## Operating distance

Repeat accuracy R	max.10 %
-------------------	----------

## Miscellaneous

in compliance with

EN ISO 13849-1:2015; EN 50178:1997; EN 60204-1:2006/A1:2009; EN ISO 14119:2013; EN 61000-6-2:2005; EN 61000-6-3:2007/A1:2011; EN 60947-5-3:2013

permissible actuators

CMS-M-BH

[1] During mounting it is to be ensured the marking arrows on actuator and read head are opposite each other.

### Dimension drawing

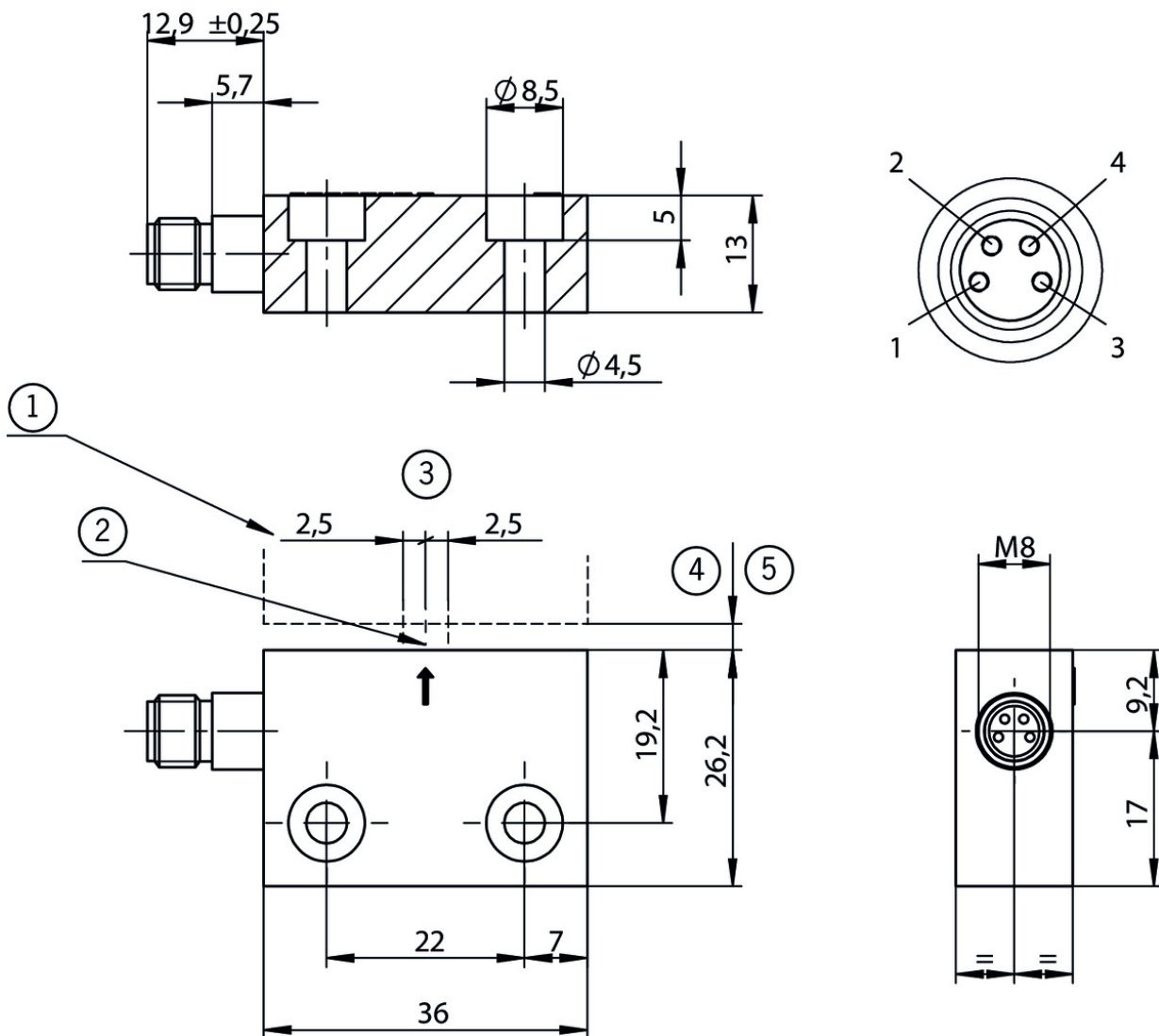

### Legende

- 1 Actuator
- 2 Active face
- 3 Center offset m at s=3 mm
- 4 Sao
- 5 Assured operating distance

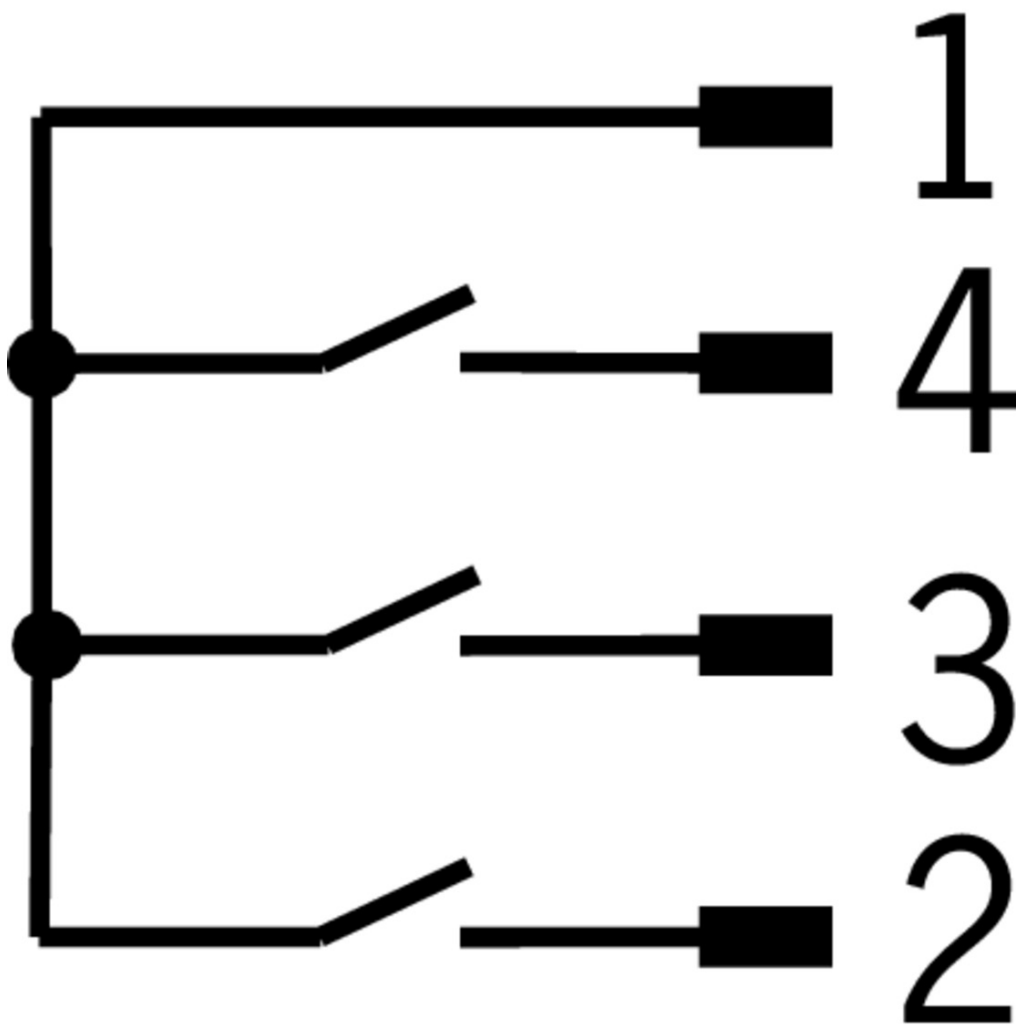

## Actuator

Actuator CMS design B



**092025** CMS-M-BH





Features

› Cube-shaped version 36 x 26 mm

## Instructions







Betriebsanleitung Leseköpfe/Betätiger für Auswertegeräte CMS

Doc. no.   Version   Language   Download

Betriebsanleitung Leseköpfe/Betätiger für Auswertegeräte CMS	2102384	07-06/18	   	 1.5 MB
Operating Instructions Read Heads/Actuators for Evaluation Units CMS				
Manual de instrucciones de cabezas de lectura/actuadores para unidades de evaluación CMS				
Mode d'emploi têtes de lecture/actionneurs pour analyseurs CMS				

## Catalogs

- Magnetisch codierte Sicherheitsschalter CMS Système de sécurité sans contact CMS  
Magnetically Coded Safety Switches CMS

	Doc. no.	Version	Language	Download
Magnetisch codierte Sicherheitsschalter CMS	086823	09-02/18		 2.3 MB
Système de sécurité sans contact CMS	090606	09-02/18		 2.3 MB
Magnetically Coded Safety Switches CMS	086824	09-02/18		 2.3 MB