

**ITEM 115117 CMS-R-BXI-07P**

Description	Technical data	Accessories	Downloads
-------------	----------------	-------------	-----------



**Features**

- › In combination with evaluation units CMS-E-BR/CMS-E-ER/CMS-E-FR
- › Cube-shaped version 36 x 26 mm
- › Connection cable
- › Cable type: PUR

**Alignment of read head and actuator**

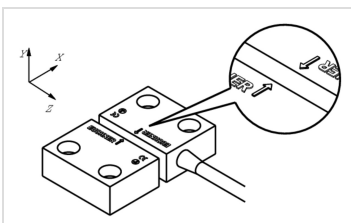

› Figure

**Operating diagram, design B**



## Operating distance

Repeat accuracy R

max.10 %

## Miscellaneous

in compliance with

EN ISO 13849-1:2015; EN 50178:1997; EN 60204-1:2006/A1:2009; EN ISO 14119:2013; EN 61000-6-2:2005; EN 61000-6-3:2007/A1:2011; EN 60947-5-3:2013

[1] During mounting it is to be ensured the marking arrows on actuator and read head are opposite each other.

## Dimension drawing

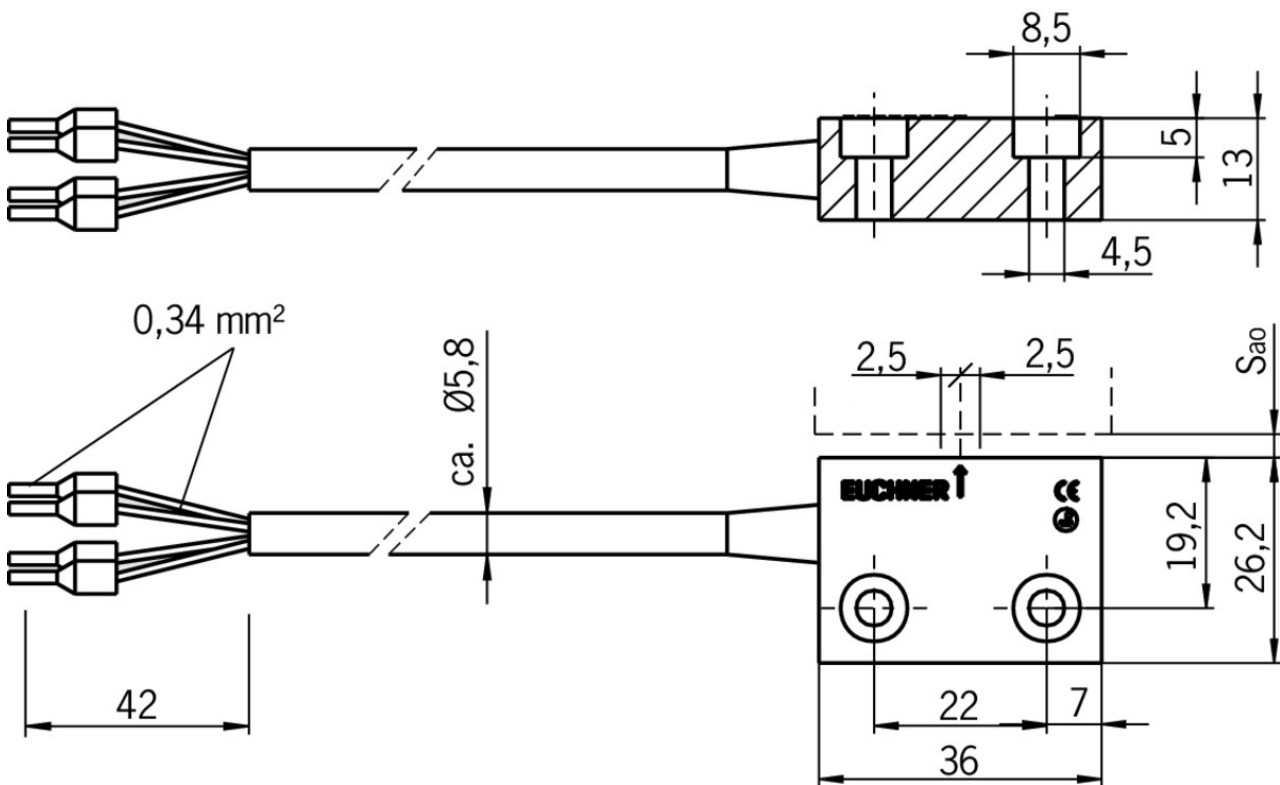

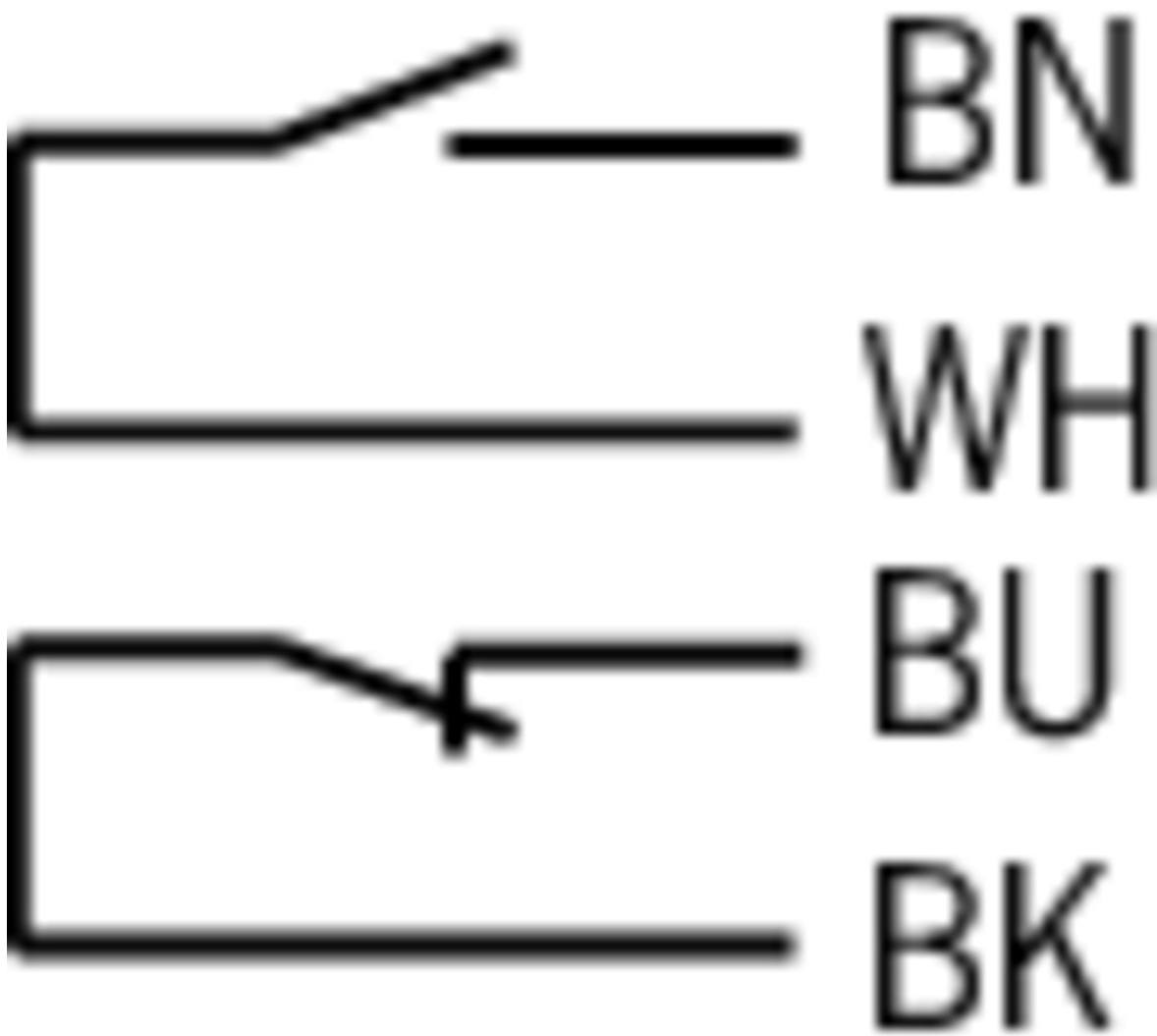

## Actuator

- Actuator CMS design B



**085531** CMS-M-BD





- Features

- › Cube-shaped version 36 x 26 mm

## Instructions







- Betriebsanleitung Leseköpfe/Betätiger für Auswertegeräte CMS

Doc. no.    Version    Language    Download

Betriebsanleitung Leseköpfe/Betätiger für Auswertegeräte CMS	2085673	15-04/18	   	 1.8 MB
Operating Instructions Read Heads/Actuators for Evaluation Units CMS				
Manual de instrucciones de cabezas de lectura/actuadores para unidades de evaluación CMS				
Mode d'emploi des têtes de lecture/actionneurs pour analyseurs CMS				

## Catalogs

- Magnetisch codierte Sicherheitsschalter CMS Système de sécurité sans contact CMS  
Magnetically Coded Safety Switches CMS

	Doc. no.	Version	Language	Download
Magnetisch codierte Sicherheitsschalter CMS	086823	09-02/18		 2.3 MB
Système de sécurité sans contact CMS	090606	09-02/18		 2.3 MB
Magnetically Coded Safety Switches CMS	086824	09-02/18		 2.3 MB