

ITEM 113209 CMS-RH-BYB-03VL

Description	Technical data	Accessories	Downloads
-------------	----------------	-------------	-----------



Features

- › Cube-shaped version 36 x 26 mm
- › Hard-wired encapsulated cable made of PVC, 3 m

Important: Actuators must be ordered separately!

Alignment of read head and actuator

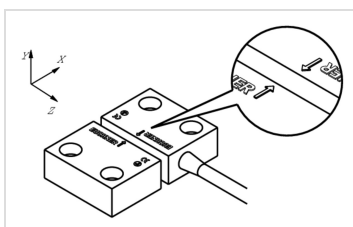

› Figure

Operating diagrams, design B

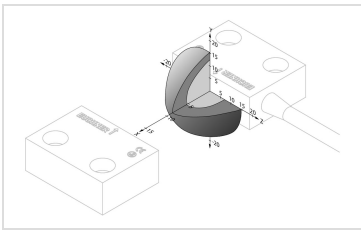

➤ CMS-RH-BYB

Typ. switch-on distance

Typ. switch-off distance

Approvals



Mechanical values and environment

Design	B
Material	
Cable material	PVC
Housing material	Fiber glass reinforced PPS
Weight	
Net	0,16 kg
Ambient temperature	-5 ... 55 °C
Degree of protection	IP67
Installation position	Any, pay attention to marking [1]
Tightening torque	0,4 ... 0,5 Nm
Number of NC contacts	1 NC contact
Number of NO contacts	1 NO contact
Connection	Hard-wired encapsulated cable with cable end sleeves 0.25mm ²
Cable length	3 m
Mechanical life	100 x 10 ⁶
Method of operation	Hall sensor

Electrical connection ratings

Current consumption	max.35 mA
Switching voltage	20 ... 35 V
Switching current	max.15 mA
Switching characteristics	NO + NC
LED indicator	1 LED green

Miscellaneous

in compliance with

EN ISO 13849-1:2015; EN 50178:1997; EN 60204-1:2006/A1:2009; EN ISO 14119:2013; EN 61000-6-2:2005; EN 61000-6-3:2007/A1:2011; EN 60947-5-3:2013

[1] During mounting it is to be ensured the marking arrows on actuator and read head are opposite each other.

Dimension drawing

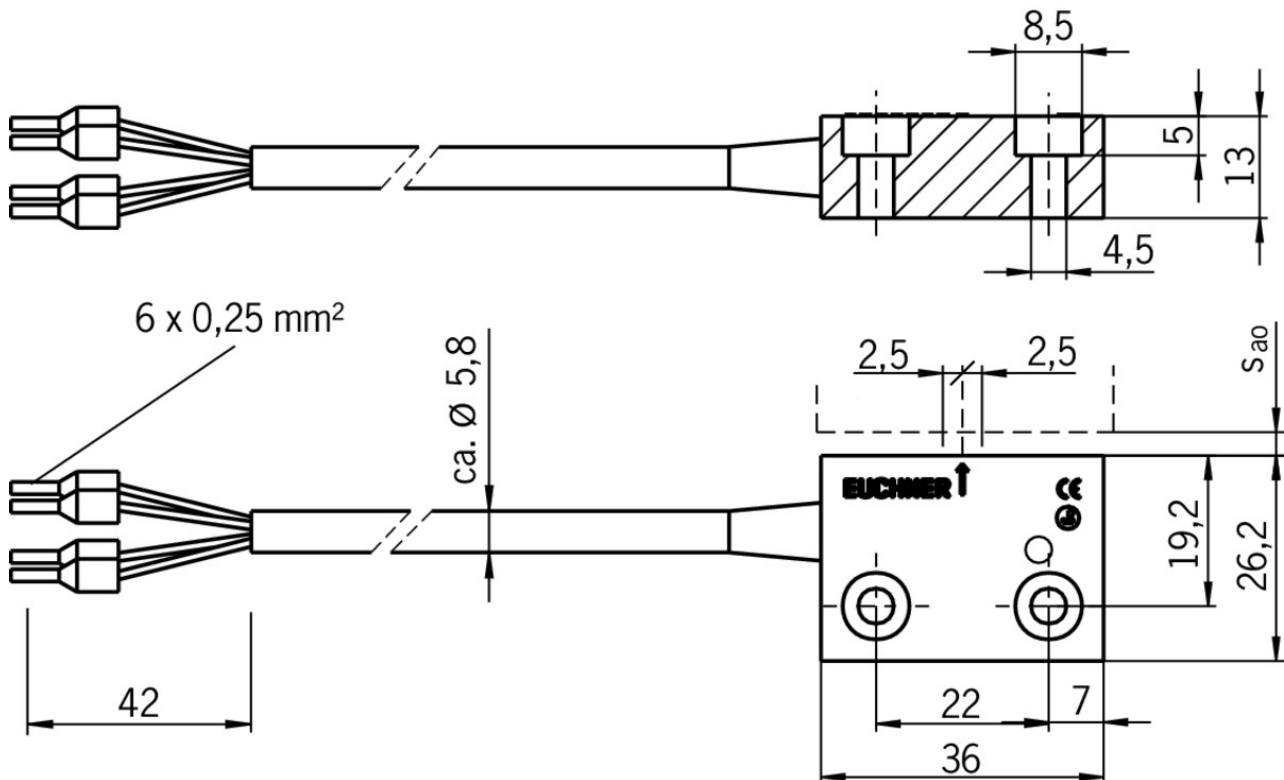

Actuator

✓ Actuator CMS with Hall sensors - design B



113213 CMS-MH-BB





✓ Features

› Cube-shaped version 36 x 26 mm

Instructions



✓ Betriebsanleitung Leseköpfe/Betätiger mit Hallsensoren für Auswertegeräte CMS

Doc. no. Version Language Download

Betriebsanleitung Leseköpfe/Betätiger mit Hallsensoren für Auswertegeräte CMS Operating Instructions Read Heads/Actuators with Hall Sensors for Evaluation Units CMS Manual de instrucciones de las cabezas de lectura/actuadores con sensores Hall para unidades de evaluación CMS Mode d'emploi des têtes de lecture/actionneurs avec capteurs à effet Hall pour analyseurs CMS	2113226	05-06/18	   	 0.9 MB
--	---------	----------	---	---

Catalogs

Unempfindlich gegen Vibrationen – die neuen CMS-Leseköpfe

	Doc. no.	Version	Language	Download
Unempfindlich gegen Vibrationen – die neuen CMS-Leseköpfe Insensitive to vibrations – the new CMS read heads	115118	02-04/17	 	 0.3 MB