

ITEM 073265 ZSB2A2G10C

Description	Technical data	Accessories	Downloads
-------------	----------------	-------------	-----------



Features

- › Housing G1
- › 3-stage function
- › Straight connection cable, 10 m
- › Plug connector
- › 2 buttons

Switching element

210 2 NO + 1 NC ↻

3-stage function

Enabling function is active only in the second stage (middle position, actuating point). If the pushbutton is released or pushed further (panic function), the enabling is removed (dependent on the wiring, see function sequence).

+ and - buttons

These buttons can be configured individually. For example, for moving axes in positive or negative direction.

Approvals



Mechanical values and environment

Material	Housing	Plastic black
	Cap	Elastomer PAK arm, black
Weight	Net	2,5 kg
	Ambient temperature	-5 ... 50 °C
Degree of protection	IP65	
Mechanical life	Position 1-2-1	min.0,1 x 10 ⁶
	Position 1-2-3-1	min.0,1 x 10 ⁶
Switching principle	Slow-action contact element	
Number of positively driven contacts	1	
Number of NO contacts	2	
Connection	Plug connector number of pins 12	
Cable length	straight	10 m

Electrical connection ratings

Rated conditional short-circuit current	100 A	
Utilization category according to EN 60947-5-1	AC-15	2A 24V 400mA 24V
	DC-13	2A 24V 100mA 24V
	Short circuit protection according to IEC 60269-1	
	at 24V	2A gG [1]
	Additional elements at 24V	0.1A gG [2]
Rated insulation voltage U _i	250 V	
Rated impulse withstand voltage U _{imp}	0,8 kV	
Switching voltage	Min. at 10mA	min.12 V
	Switching current	
	Min. at 24 V	min.1 mA
Degree of contamination (external, according to EN 60947-1)	Industry	3

Connecting cable	8x0.5mm ² + 8x0.14mm ² [3]
------------------	--

Miscellaneous

Additional feature	Version	2 buttons (+ and -)
--------------------	---------	---------------------

Reliability values acc. to EN ISO 13849-1

	Enabling switch
B10 _D	0,5 x 10 ⁶

[1, 2] In case of operating voltages other than DC 24V, the short circuit protection must be dimensioned accordingly and checked.

[3] 4x0.5mm² screened + 4x0.5mm² unscreened + 8x0.14mm² unscreened. Outer screen over everything.

Dimension drawing

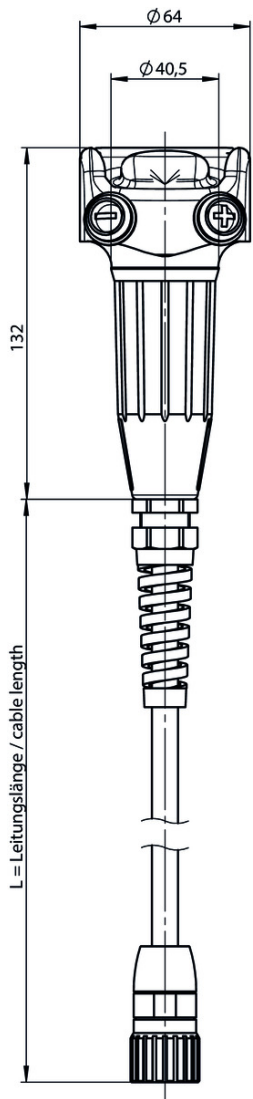

Polbild / Mating face
Ansicht Steckseite / View of connection side
2:1

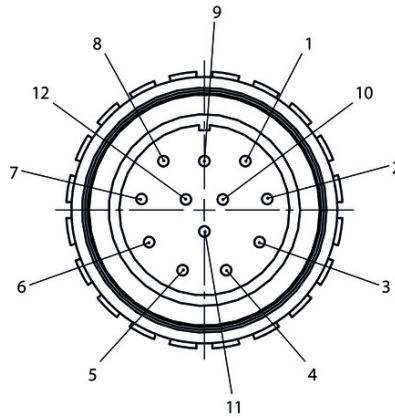

Dimension drawing

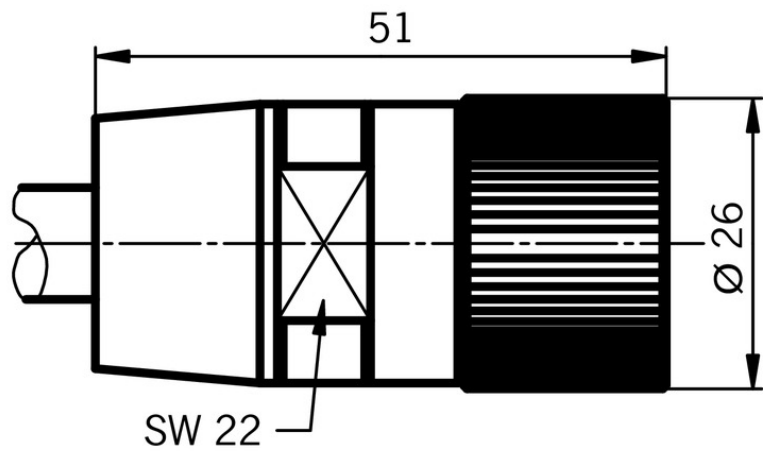
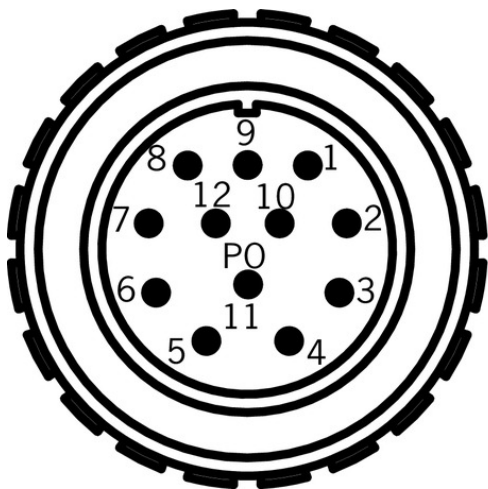

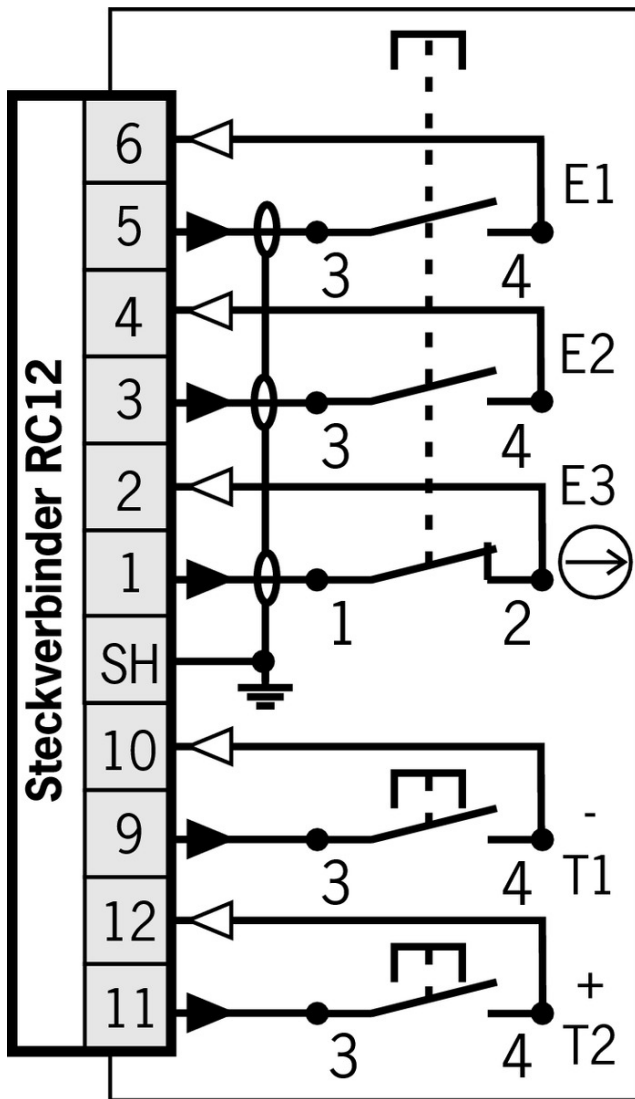

Travel diagram

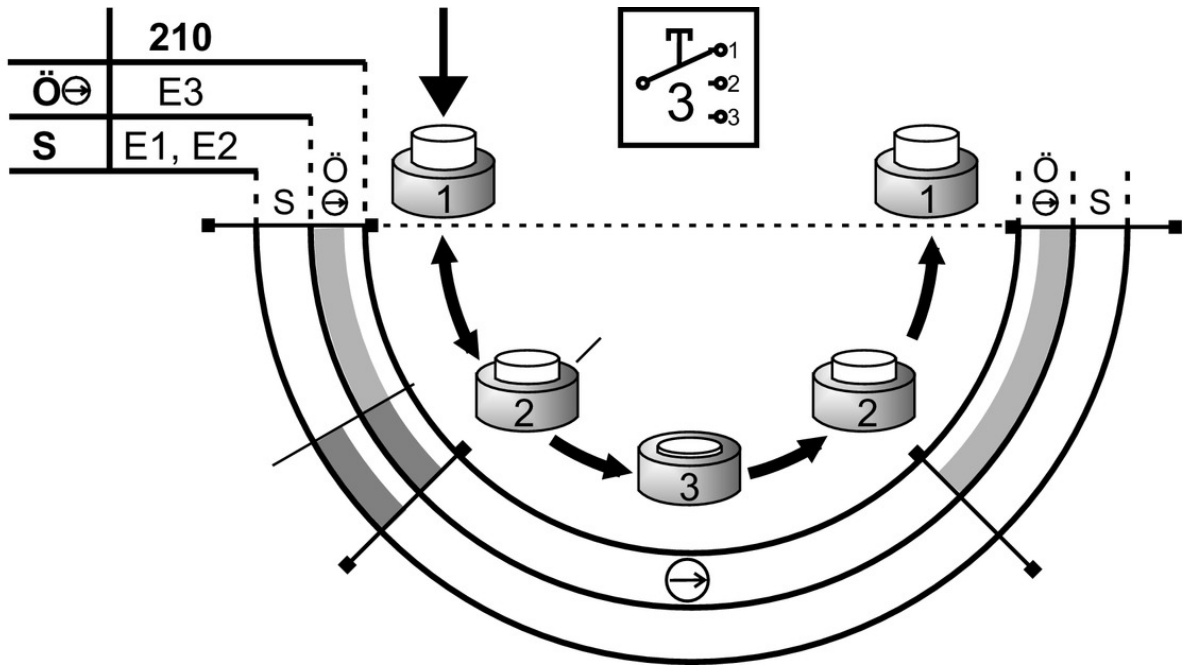

Legende

- open
- closed
- closed, enabling

Mounting accessories

- Screw holder with cable hook for hand-held enabling switches

047820 LEITUNGSHALTER

- Features

Screw holder for housing G1 with cable hook

- Screw holder for hand-held enabling switches

052406 HALTER KPL.

- Features

Screw holder for housing G1

- Magnetic holder for hand-held enabling switches







059340 MAGNETHALTERUNG ZUSTIMMTASTER

- Features

Magnetic holder for housing G1



Instructions

▼ Betriebsanleitung Zustimmtaster ZSB

	Doc. no.	Version	Language	Download
Betriebsanleitung Zustimmtaster ZSB	092782	06-12/13		 0.5 MB
Mode d'emploi de la commande d'assentiment ZSB				
Istruzioni di impiego del pulsante di consenso ZSB				
Operating Instructions Enabling Switch ZSB				





Catalogs

▼ Enabling switches ZS Commandes d'Assentiment ZS Zustimmtaster ZS

	Doc. no.	Version	Language	Download
Zustimmtaster ZS	095689	08-07/18		 9.1 MB
Commandes d'Assentiment ZS	097367	08-07/18		 4.9 MB
Enabling switches ZS	095690	08-07/18		 4.9 MB

Declaration of conformity

▼ EU-Konformitätserklärung

	Doc. no.	Version	Language	Download
EU-Konformitätserklärung	2109392	04-11/16		 0.2 MB
Declaración UE de conformidad				
Déclaration UE de conformité				
Dichiarazione di conformità				
EU declaration of conformity				

CAD data

CAD data for this item on TraceParts