

## ITEM 096703 ZSB2B7CAS1

Description	Technical data	Accessories	Downloads
-------------	----------------	-------------	-----------



### Features

- › Housing G1
- › 3-stage function
- › Positively driven contacts
- › Dual-channel version
- › 2 buttons (+ and -)

### AS-Interface inputs

**D0, D1** NO contact

**D2, D3** NO contact

### 3-stage function

Enabling function is active only in the second stage (middle position, actuating point). Enabling is canceled when the button is released or pushed all the way down (panic function).

### Approvals

## Mechanical values and environment

Material	Plastic
Weight	
	Net 0,5 kg
Ambient temperature	-5 ... 50 °C
Degree of protection	IP65 mating connector inserted and screwed tight
Mechanical life	
	Position 1-2-1 0,1 x 10 <sup>6</sup>
	Position 1-2-3-1 0,1 x 10 <sup>6</sup>
Switching principle	Slow-action contact element
Number of NO contacts	2
Connection	M12 plug connector, 4-pin

## Electrical connection ratings

ASi voltage	22,5 ... 30 V 31,6 V
ASi operating current	max.45 mA
Degree of contamination (external, according to EN 60947-1)	3
Switching characteristics	3-stage enabling switch
ASi slave type	
According to ASi specification 3.0	EA code: 7
According to ASi specification 3.0	ID code: B
ASi data in	
According to ASi safety at work	D0, D1, D2, D3 <b>[1]</b>
ASi parameter in	
Minus pushbutton	P 1
Plus pushbutton	P 0

## Miscellaneous

Additional feature	2 buttons (+ and -)
in compliance with	60947-5-8

## Reliability values acc. to EN ISO 13849-1

	<b>Enabling switch</b>
B10 <sub>D</sub>	0,5 x 10 <sup>6</sup>

[1] NO contact E1 on D0, D1 NO contact E2 on D2, D3

**Dimension drawing**

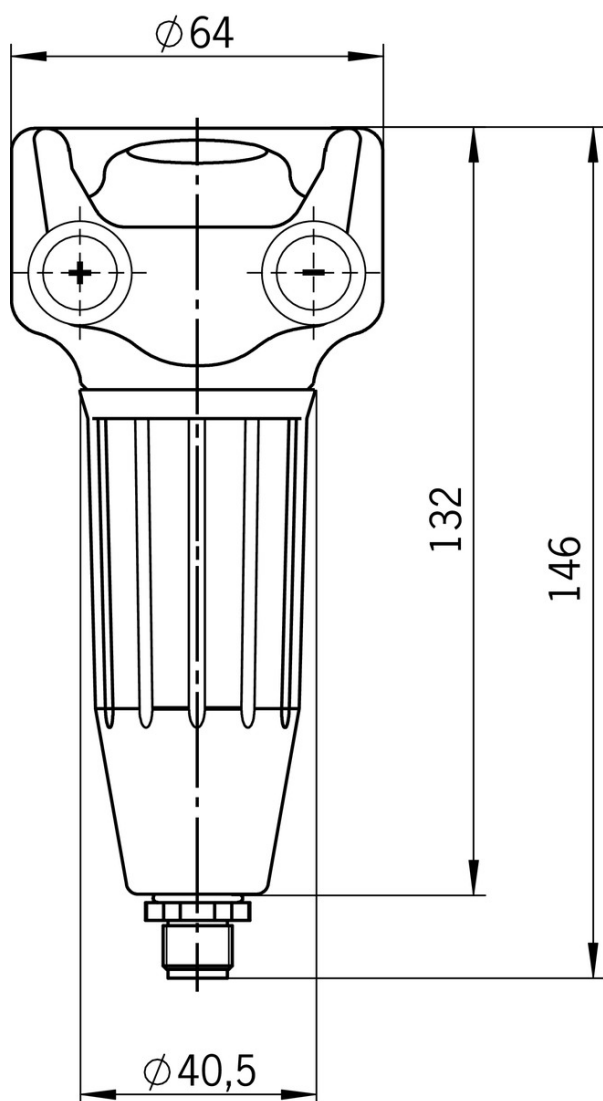

**Connector assignment**

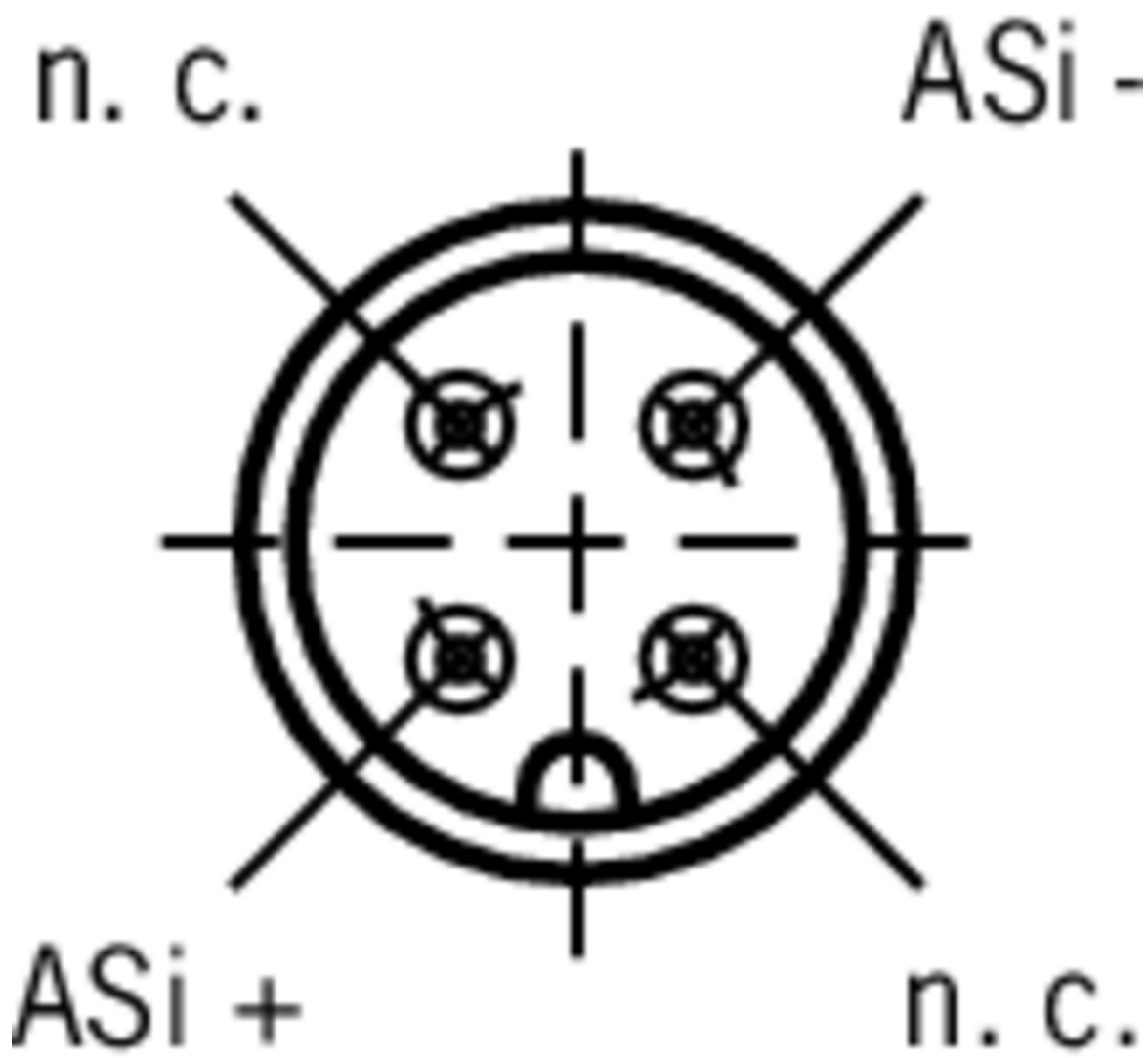

**Legende**

View of connection side

## Travel diagram

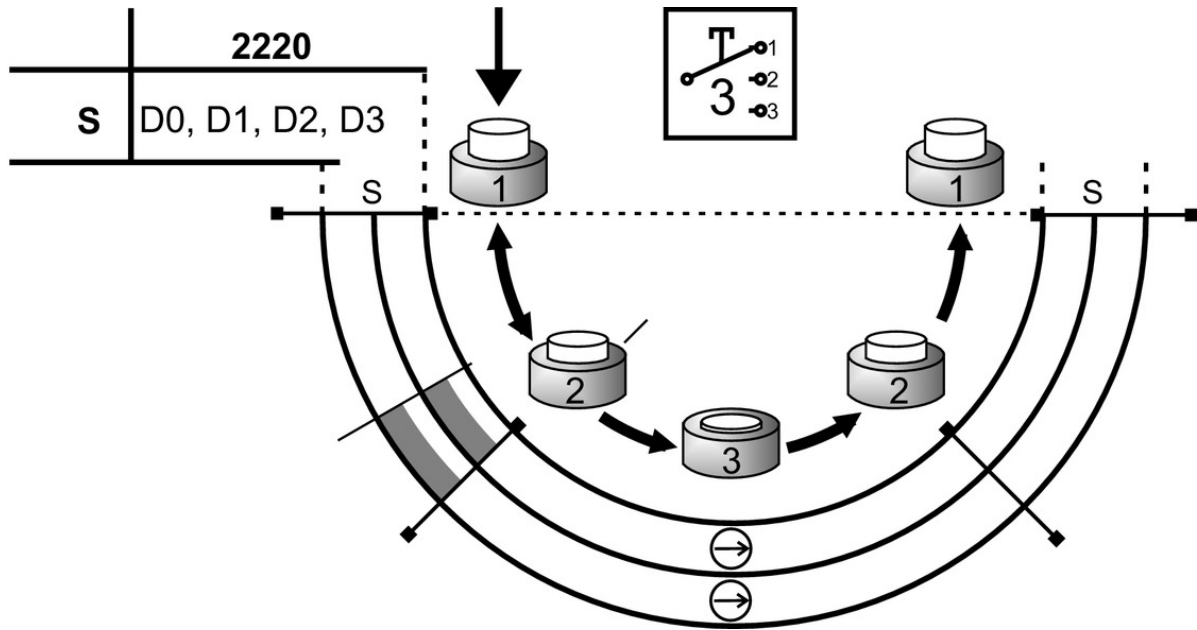

## Legende

- open
- closed
- closed, enabling

## Mounting accessories

- Magnetic holder for hand-held enabling switches



**059340** MAGNETHALTERUNG ZUSTIMMTASTER

Features

Magnetic holder for housing G1

- Screw holder for hand-held enabling switches

**052406** HALTER KPL.

Features

Screw holder for housing G1

- Screw holder with cable hook for hand-held enabling switches

**047820** LEITUNGSHALTER

Features

Screw holder for housing G1 with cable hook

## Connection material

### Bus coupling module with plug connector M12, 5-pin





#### 105756 BCM-A-P2-SEM4-1

##### Features

- › Conversion from M12 to ribbon cable
- › Very compact design
- › Easy handling







## Instructions

### Betriebsanleitung Zustimmtaster ZS...AS1

	Doc. no.	Version	Language	Download
Betriebsanleitung Zustimmtaster ZS...AS1	114123	02-04/13		 0.2 MB
Operating Instructions Enabling Switch ZS...AS1				





## Catalogs

### Sicherheitsschalter mit AS-Interface Safety Switches with AS-Interface Interrupteurs de sécurité avec AS-Interface

	Doc. no.	Version	Language	Download
Sicherheitsschalter mit AS-Interface	092164	11-04/17		 2.3 MB
Interrupteurs de sécurité avec AS-Interface	112564	11-04/17		 2.3 MB
Safety Switches with AS-Interface	092332	11-04/17		 2.3 MB

## Declaration of conformity

### EU-Konformitätserklärung

	Doc. no.	Version	Language	Download
EU-Konformitätserklärung	2109392	04-11/16		 0.2 MB
Declaración UE de conformidad				
Déclaration UE de conformité				
Dichiarazione di conformità				
EU declaration of conformity			