

## ITEM 070782 ZSE2-3

Description	Technical data	Accessories	Downloads
-------------	----------------	-------------	-----------



### Features

- › 3-stage function
- › 30.5 mm installation dimension
- › Suitable, e.g. for installation in the hand-held pendant stations HBL or housing G2 or G3

### 3-stage function

Enabling function is active only in the second stage (middle position, actuating point). If the pushbutton is released or pushed further (panic function), the enabling is removed (dependent on the wiring, see function sequence).

### Switching element

**121** 1NO + 2NC  $\ominus$  + 1NC

### Approvals



## Mechanical values and environment

Material	Cap	Elastomer PAK arm, black
Housing material		Plastic, color black
Weight	Net	0,1 kg
Ambient temperature		-5 ... 60 °C
Degree of protection	On the front	IP65
	Connections	IP00
Mechanical life	Position 1-2-1	cyclesmin.0,1 x 10 <sup>6</sup>
	Position 1-2-3-1	cyclesmin.0,1 x 10 <sup>6</sup>
Switching principle		Slow-action contact element
Mounting method		IEC 947-5-1 D30 [1]
Installation position		Any
Number of positively driven contacts		2
Number of NC contacts		1
Number of NO contacts		1
Connection		Tab connector 2.8 x 0.8 IEC 760 + soldered connection

## Electrical connection ratings

Rated conditional short-circuit current		100 A
Utilization category according to EN 60947-5-1	AC-15	4A 230V
	DC-13	3A 24V
Short circuit protection according to IEC 60269-1		4A gG
Rated insulation voltage U <sub>i</sub>		250 V
Rated impulse withstand voltage U <sub>imp</sub>		2,5 kV
Switching voltage	at 10mA	min.12 V
Switching current	at 24V	min.1 mA
Degree of contamination (external, according to EN 60947-1)	Industry	3

## Miscellaneous

in compliance with	60947-5-8
--------------------	-----------

Reliability values acc. to EN ISO 13849-1

	Enabling switch
B10D	$0,5 \times 10^6$

[1] (Bore 30.5)

Dimension drawing

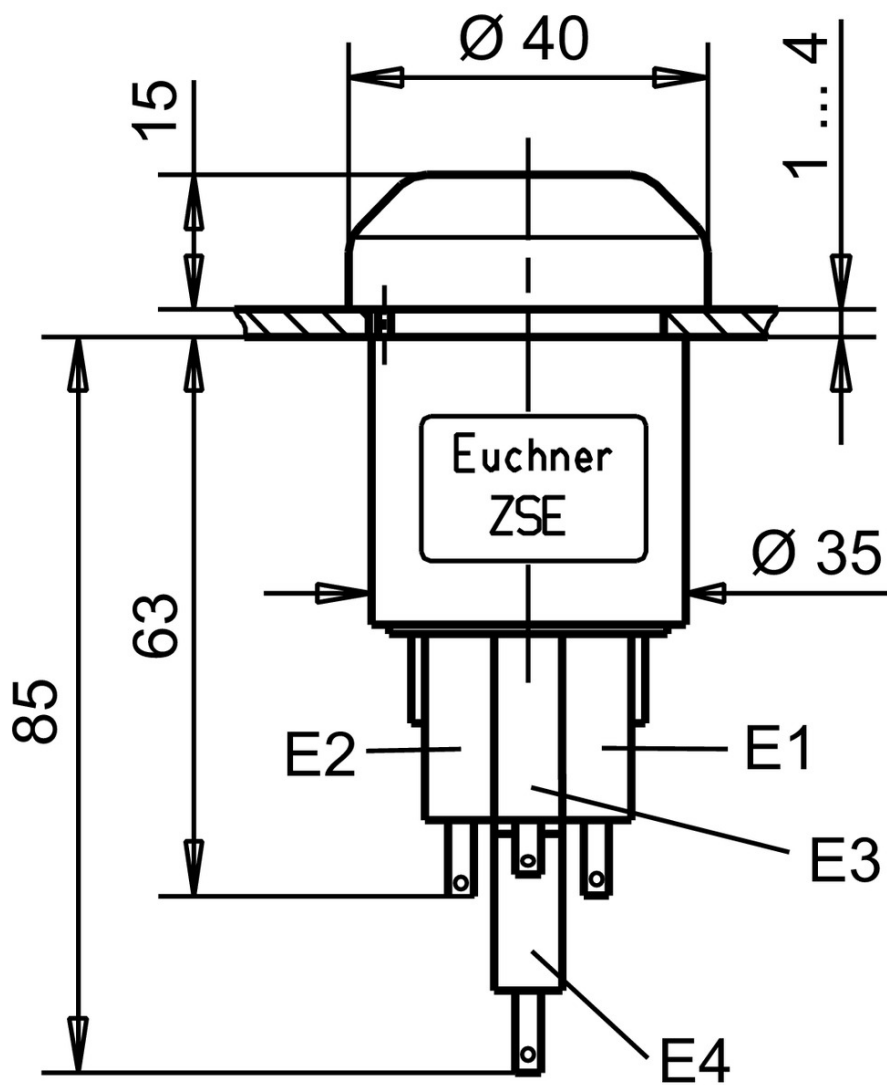

Dimension drawing

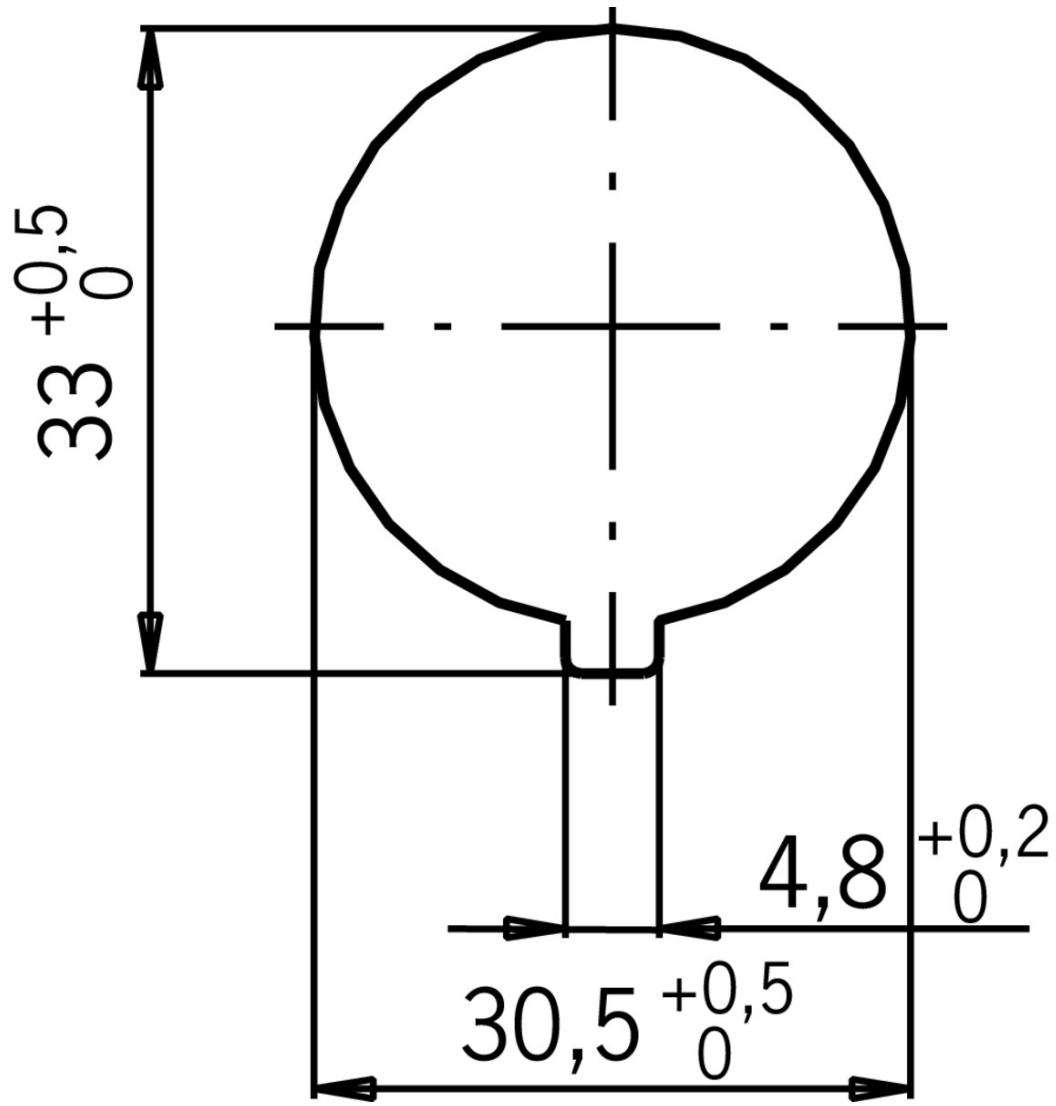

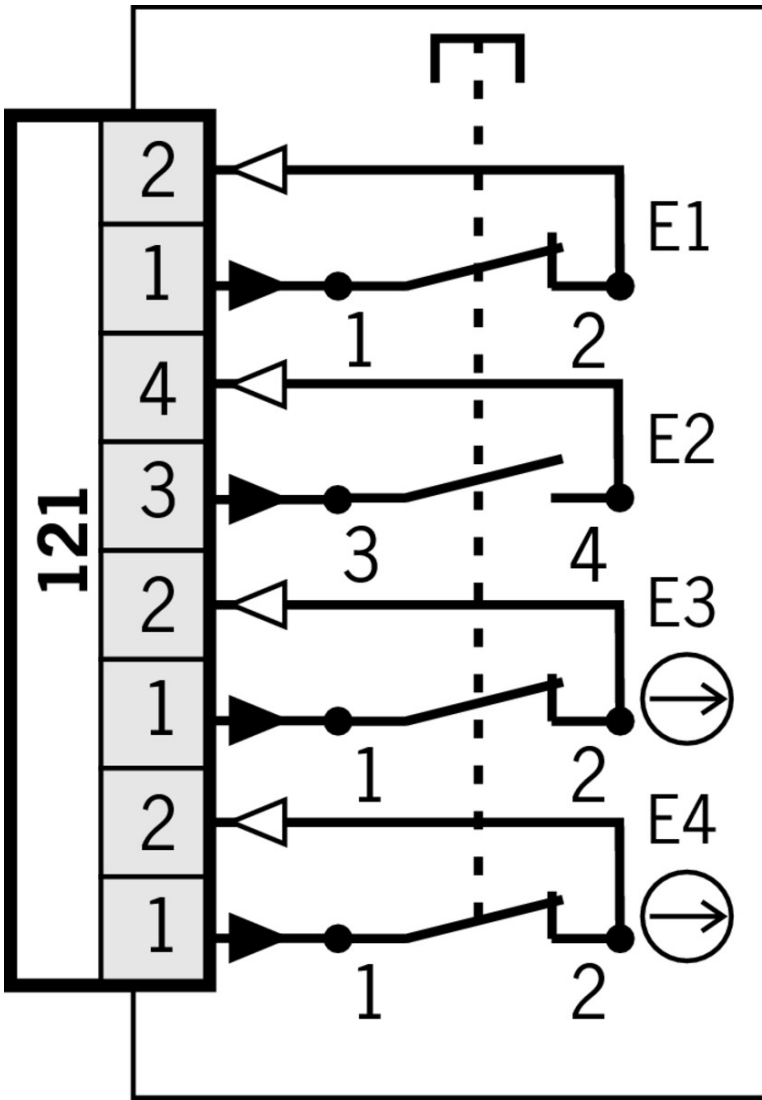

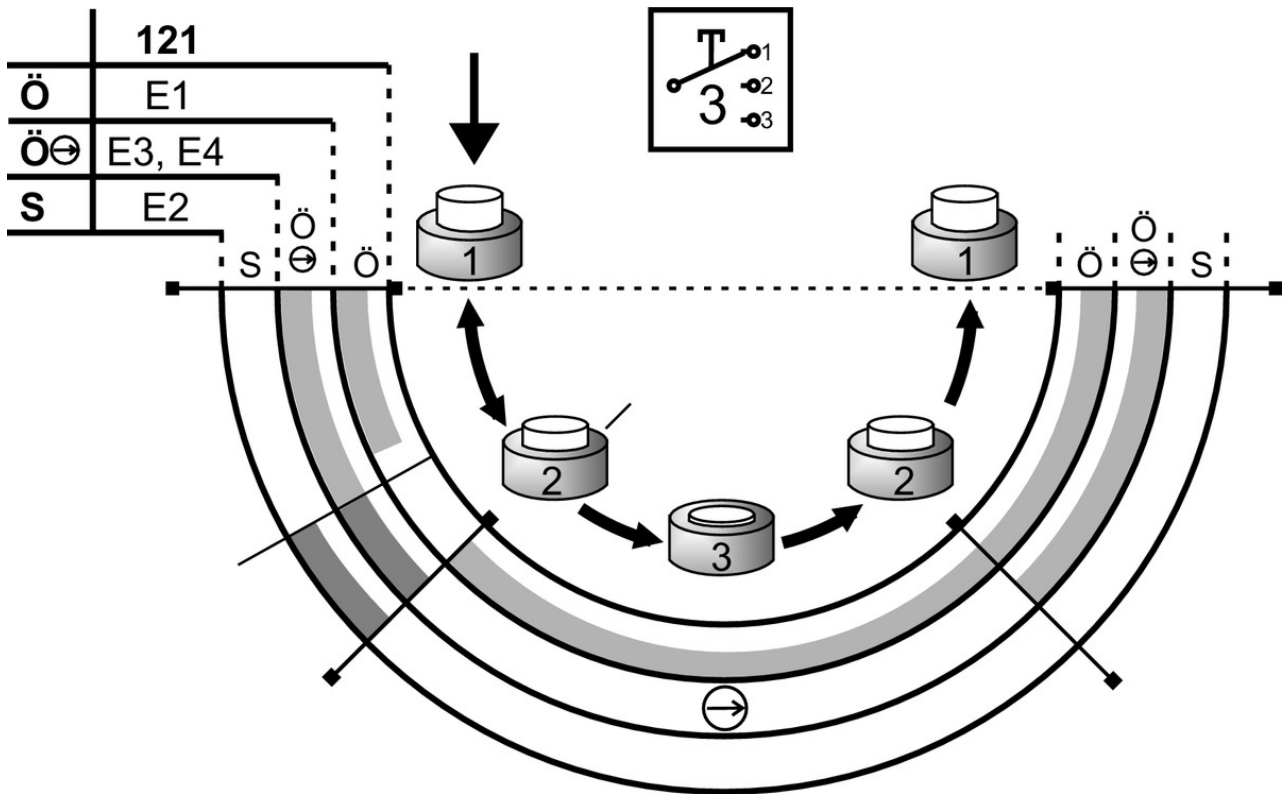

## Travel diagram



## Legende

-  open
-  closed
-  closed, enabling





## Instructions

- Betriebsanleitung Zustimmtaster ZSE

	Doc. no.	Version	Language	Download
Betriebsanleitung Zustimmtaster ZSE	092780	03-12/13		 0.4 MB
Manual de instrucciones del pulsador de validación ZSE				
Mode d'emploi de la commande d'assentiment ZSE				
Istruzioni di impiego del pulsante di consenso ZSE				
Manual de instruções da chave enable ZSE				
Operating Instructions Enabling Switch ZSE				
Návod k použití potvrdzovacího tlačítka ZSE	092780	03-12/13		 0.2 MB







## Catalogs

▼ Enabling switches ZS Commandes d'Assentiment ZS Zustimmungster ZS

	Doc. no.	Version	Language	Download
Zustimmungster ZS	095689	08-07/18		 9.1 MB
Commandes d'Assentiment ZS	097367	08-07/18		 4.9 MB
Enabling switches ZS	095690	08-07/18		 4.9 MB

**Declaration of conformity**

▼ EU-Konformitätserklärung

	Doc. no.	Version	Language	Download
EU-Konformitätserklärung	2109392	04-11/16		 0.2 MB
Declaración UE de conformidad				
Déclaration UE de conformité				
Dichiarazione di conformità				
EU declaration of conformity				

**CAD data**

CAD data for this item on TraceParts