



Mechanical values and environment

Rated actuating force according to EN 60947-5-8	max.100 N
Material	
Protective cap	CR
Housing material	Polyamide
Weight	
Net	0,03 kg
Ambient temperature	-5 ... 60 °C
Degree of protection	
On the front	IP65
Connections	IP00
Mechanical life	
Position 1-2-1	cyclesmin.0,1 x 10 ⁶
Position 1-2-3-1	cyclesmin.0,1 x 10 ⁶
Installation position	Any
Tightening torque	
Screws	max.0,15 Nm
Number of switching elements	2 NO
Connection	Screw terminal 4-pole
Stripping length	5 mm
Actuating force	max.50 N [1]

Electrical connection ratings

Rated conditional short-circuit current	100 A
Utilization category according to EN 60947-5-2	
DC-13	0.1A 24V
Fusing	
external	0,1 A Medium slow-blow
Rated insulation voltage U _i	30 V
Rated impulse withstand voltage U _{imp}	1,5 kV
Switching current	5 ... 100 mA
Degree of contamination (external, according to EN 60947-1)	3
Connection cross-section	
single conductor	0,33 ... 1,5 mm ²
multiple conductor	0,33 ... 0,75 mm ²
Connection cross-section, AWG	
single conductor	22 ... 16 AWG
multiple conductor	22 ... 18 AWG
Breaking capacity	max.0,25 W

Miscellaneous

in compliance with	DIN EN 60947-5-8
Color	
Housing	Black
Protective cap	Black

Reliability values acc. to EN ISO 13849-1

B10 _D	$0,75 \times 10^6$
------------------	--------------------

[1] from stage 2 to 3

Dimension drawing

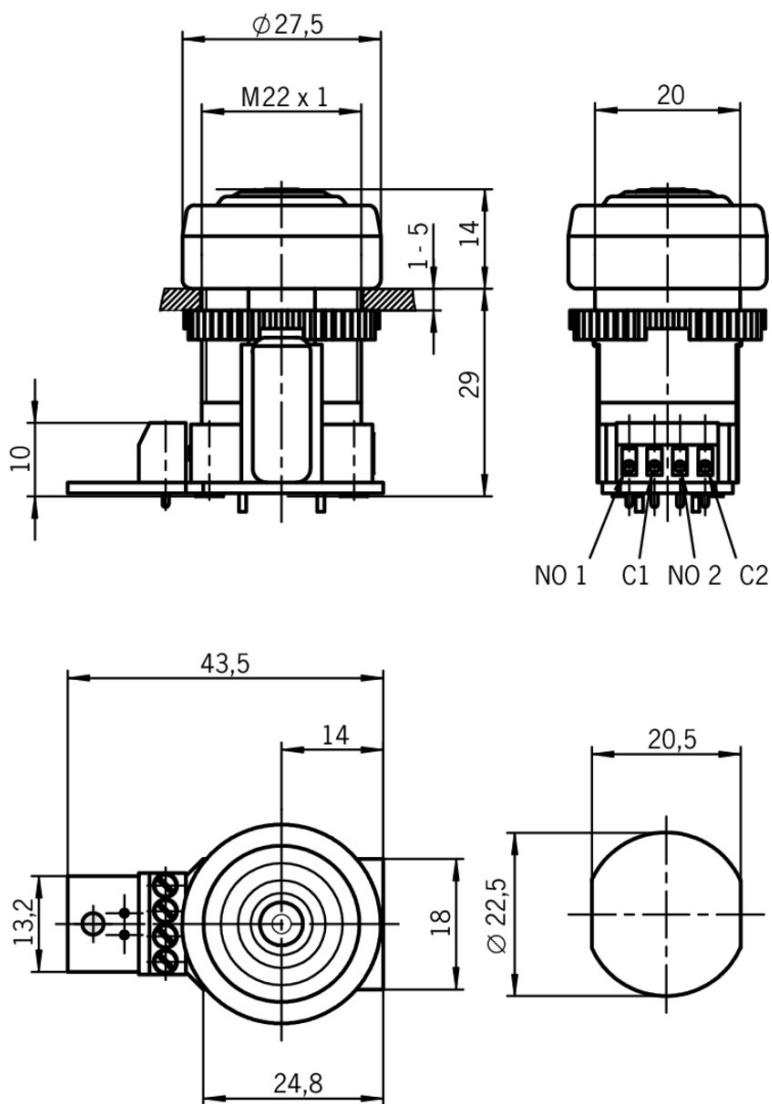

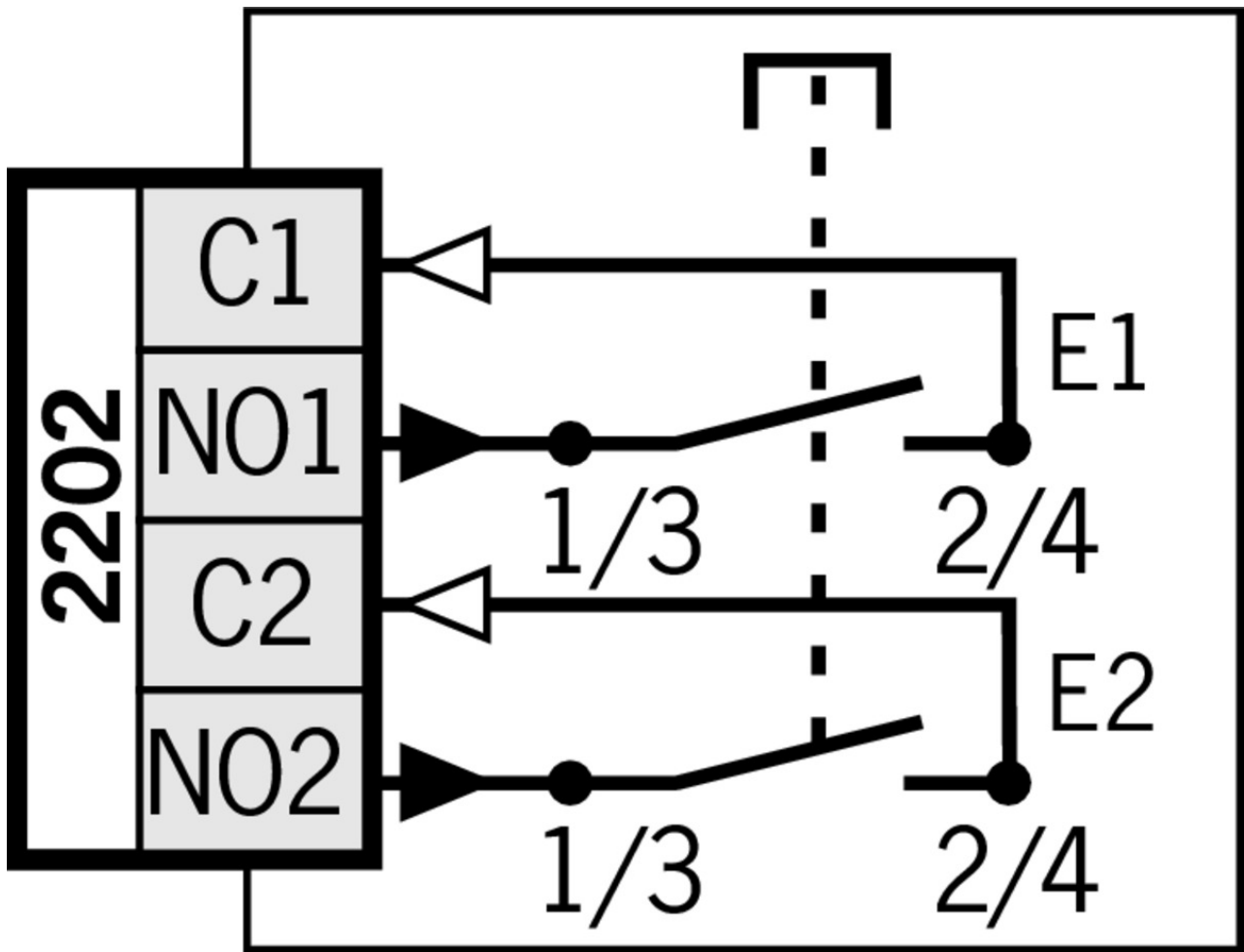

Travel diagram

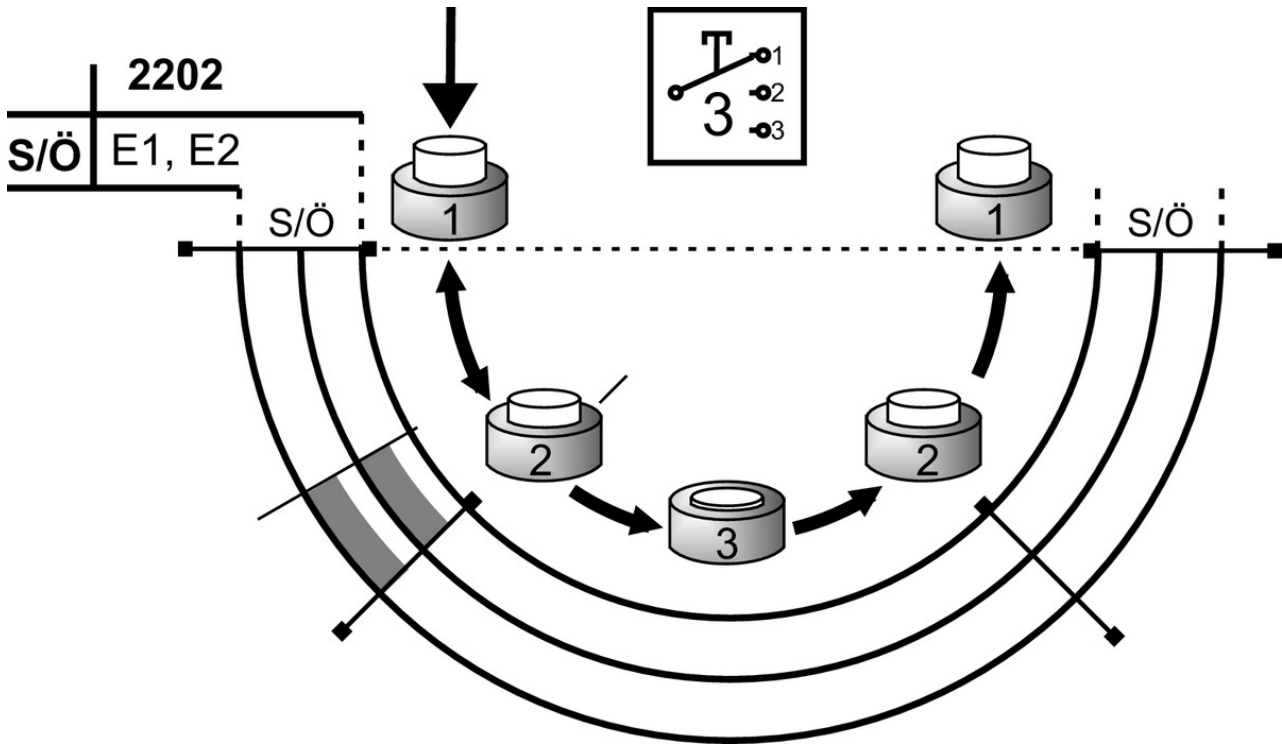

Legende

- open
- closed
- closed, enabling







Instructions

Betriebsanleitung Zustimmtaster ZXE



	Doc. no.	Version	Language	Download
Betriebsanleitung Zustimmtaster ZXE	091418	05-12/13		0.7 MB
Manual de instrucciones del pulsador de validación ZXE				
Mode d'emploi de la commande d'assentiment ZXE				
Istruzioni di impiego del pulsante di consenso ZXE				
Operating Instructions Enabling Switch ZXE				
Инструкция по эксплуатации выключателя подтверждения ZXE	091418	05-12/13		0.4 MB

Catalogs

Handbediengeräte/Handräder Hand-Held Pendant Stations/Handwheels Pupitres portables/Manivelles



	Doc. no.	Version	Language	Download
Handbediengeräte/Handräder	098619	08-09/17		 3.0 MB
Pupitres portables/Manivelles	111529	08-09/17		 3.0 MB
Hand-Held Pendant Stations/Handwheels	099443	08-09/17		 3.0 MB

Enabling switches ZS Commandes d'Assentiment ZS Zustimmungster ZS

	Doc. no.	Version	Language	Download
Zustimmungster ZS	095689	08-07/18		 9.1 MB
Commandes d'Assentiment ZS	097367	08-07/18		 4.9 MB
Enabling switches ZS	095690	08-07/18		 4.9 MB

Declaration of conformity

EU-Konformitätserklärung

	Doc. no.	Version	Language	Download
EU-Konformitätserklärung Declaración UE de conformidad Déclaration UE de conformité Dichiarazione di conformità EU declaration of conformity	2109392	04-11/16	    	 0.2 MB

CAD data

CAD data for this item on TraceParts