

ITEM 055410 ZSA2B2G05A

Description	Technical data	Accessories	Downloads
-------------	----------------	-------------	-----------



Features

- › Housing G1
- › 3-stage function
- › Straight connection cable, 5 m

Switching element

2210 1 NO/NC \ominus 1 NO (additional auxiliary contact)

Cable

The high quality connection cables (individual screening of the safety contacts) are available straight.

3-stage function

Enabling function is active only in the second stage (middle position, actuating point). If the pushbutton is released or pushed further (panic function), the enabling is removed (dependent on the wiring, see function sequence).

Approvals



Mechanical values and environment

Material	Plastic
Weight	
Net	1,5 kg
Ambient temperature	-5 ... 50 °C
Degree of protection	IP67
Mechanical life	
Position 1-2-1	$0,1 \times 10^6$
Position 1-2-3-1	$0,1 \times 10^6$
Switching principle	Slow-action contact element
Number of positively driven contacts	1
Number of NO contacts	2
Connection	Flying lead
Cable length	
straight	5 m

Electrical connection ratings

Rated conditional short-circuit current	100 A
Utilization category according to EN 60947-5-1	
AC-15	2A 230V
DC-13	2A 24V
Short circuit protection according to IEC 60269-1	2A gG [1]
Rated insulation voltage U_i	250 V
Rated impulse withstand voltage U_{imp}	2,5 kV
Switching voltage	
Min. at 10mA	12 V
Switching current	
Min. at 24V	1 mA
Degree of contamination (external, according to EN 60947-1)	3
Connecting cable	$3 \times 0,75 \text{mm}^2$ [2]
Switching characteristics	3-stage enabling switch

Miscellaneous

in compliance with	60947-5-8
--------------------	-----------

Reliability values acc. to EN ISO 13849-1

	Enabling switch
B10 _D	0,5 x 10 ⁶

[1] In case of operating voltages other than 24 V, the short circuit protection must be dimensioned accordingly and checked.

[2] 2 cores screened

Dimension drawing

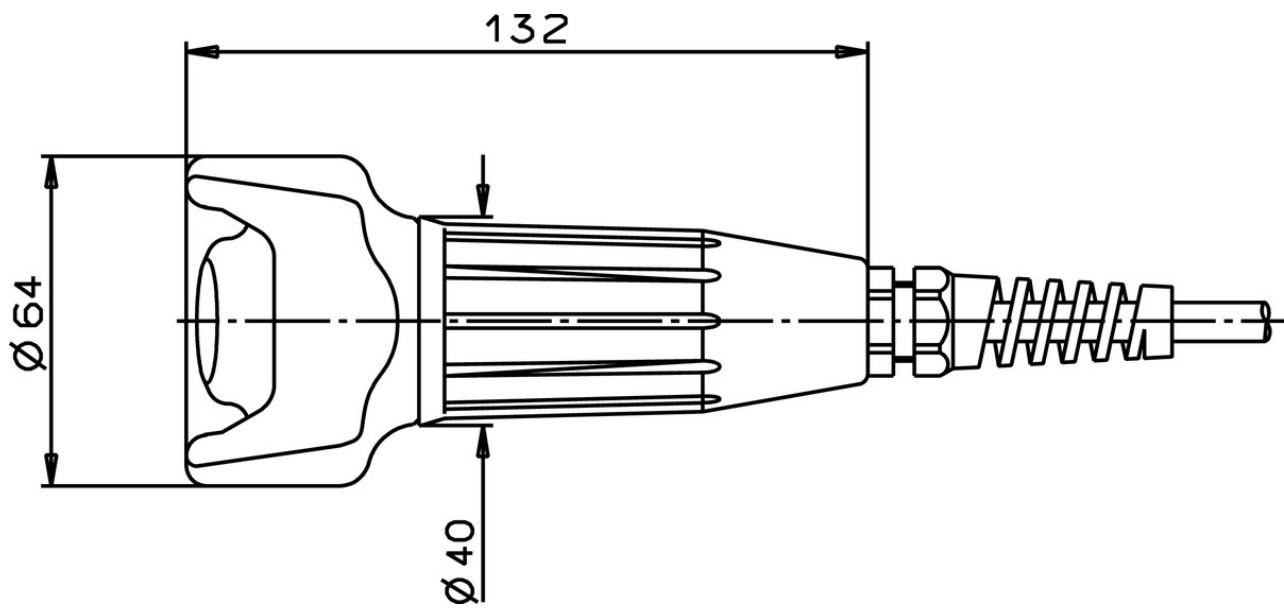

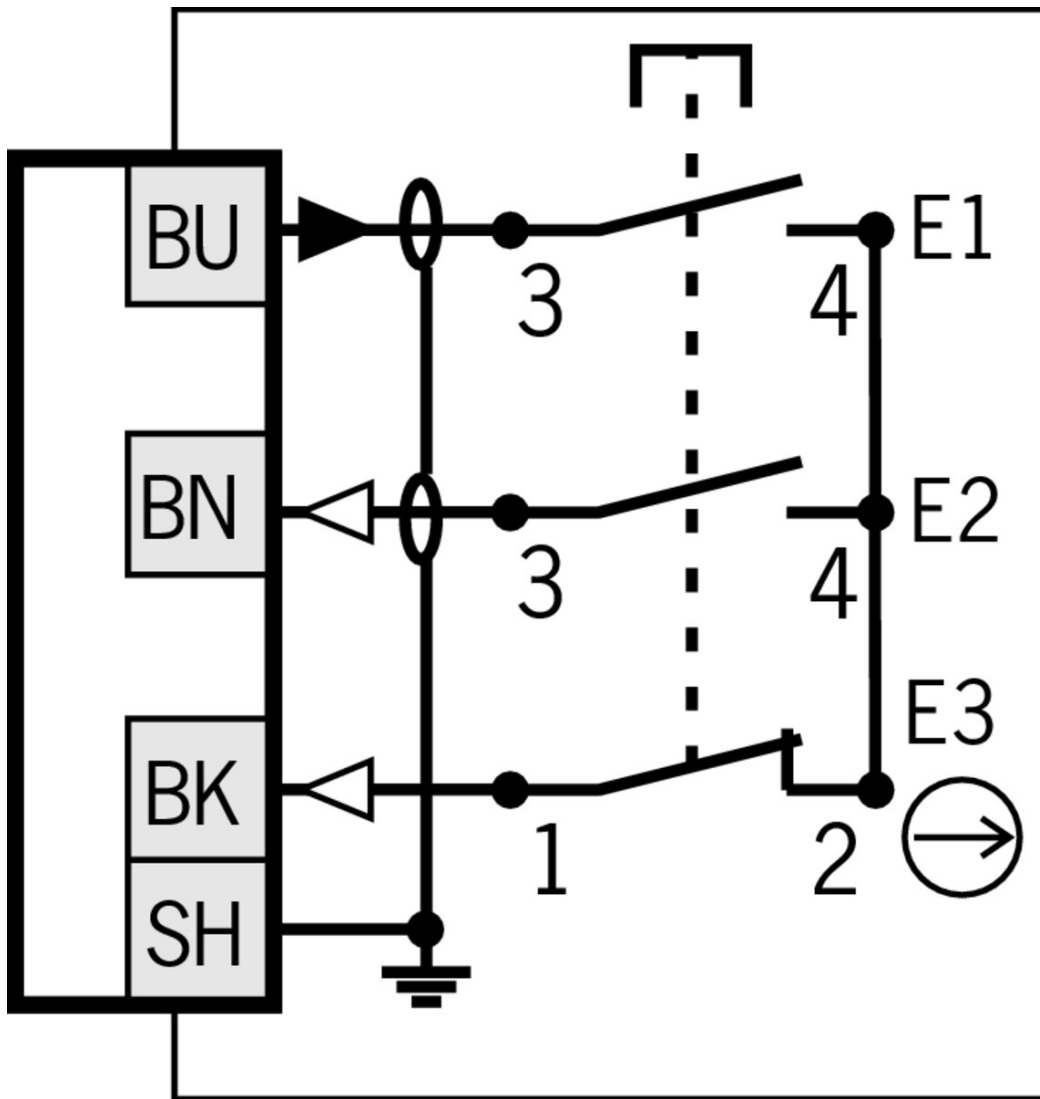

Travel diagram

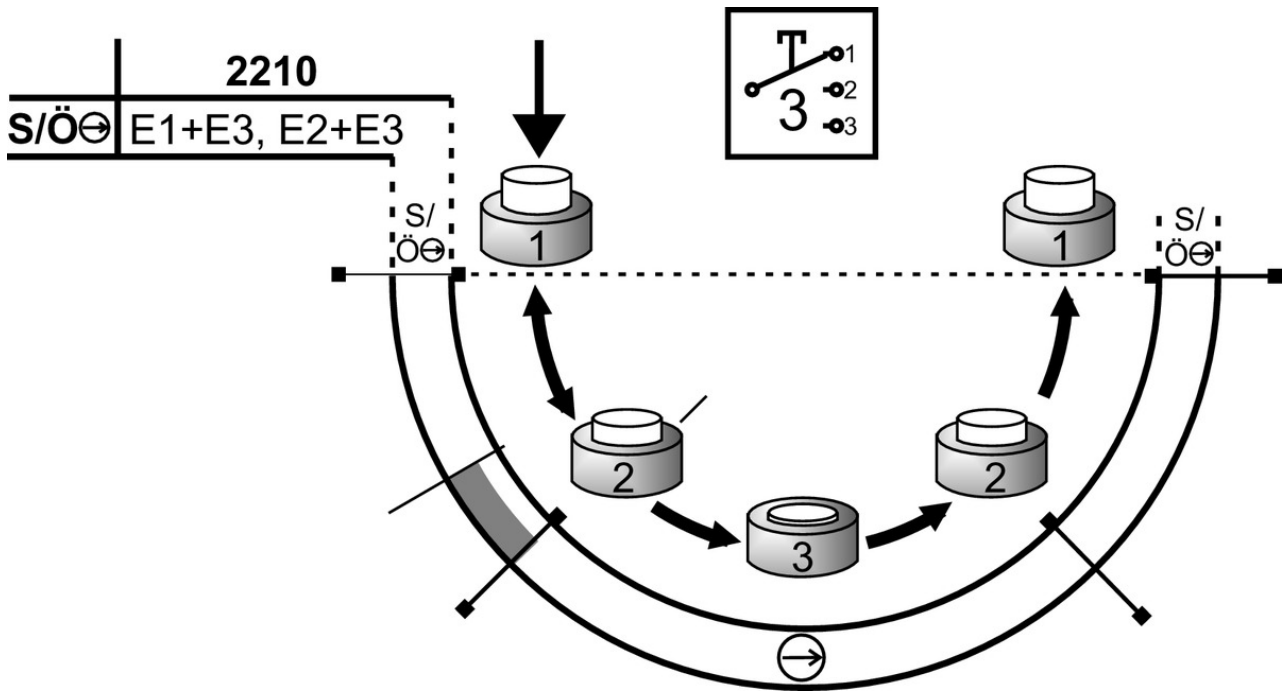

Legende

- open
- closed
- closed, enabling

Mounting accessories

- Magnetic holder for hand-held enabling switches



059340 MAGNETHALTERUNG ZUSTIMMTASTER

Features

Magnetic holder for housing G1

- Screw holder with cable hook for hand-held enabling switches

047820 LEITUNGSHALTER

Features

Screw holder for housing G1 with cable hook

- Screw holder for hand-held enabling switches

052406 HALTER KPL.

Features

Screw holder for housing G1







Instructions

▼ Betriebsanleitung Zustimmtaster ZSA/ZSR

	Doc. no.	Version	Language	Download
Betriebsanleitung Zustimmtaster ZSA/ZSR	092781	06-11/13		 0.6 MB
Mode d'emploi de la commande d'assentiment ZSA/ZSR				
Istruzioni di impiego del pulsante di consenso ZSA/ZSR				
Operating Instructions Enabling Switch ZSA/ZSR				







Catalogs

▼ Enabling switches ZS Commandes d'Assentiment ZS Zustimmtaster ZS

	Doc. no.	Version	Language	Download
Zustimmtaster ZS	095689	08-07/18		 9.1 MB
Commandes d'Assentiment ZS	097367	08-07/18		 4.9 MB
Enabling switches ZS	095690	08-07/18		 4.9 MB

Declaration of conformity

▼ EU-Konformitätserklärung

	Doc. no.	Version	Language	Download
EU-Konformitätserklärung	2109392	04-11/16		 0.2 MB
Declaración UE de conformidad				
Déclaration UE de conformité				
Dichiarazione di conformità				
EU declaration of conformity				

CAD data

CAD data for this item on TraceParts