

ITEM 103462 ZSM3100-103462

Description	Technical data	Accessories	Downloads
-------------	----------------	-------------	-----------



Features

- › 3-stage function
- › + and - buttons
- › Selector switches
- › Coiled connection cable, 5 m

3-stage function

Enabling function is active only in the second stage (middle position, actuating point). If the pushbutton is released or pushed further (panic function), the enabling is removed (dependent on the wiring, see function sequence).

+ and - buttons

These buttons can be configured individually. For example for moving axes in the positive or negative direction.

Selector switches

As required, the adjustable detent positions can, e.g. be used for axis, speed or range selection.

Cable

The high-quality connection cables are available in a coiled version.

Approvals



Mechanical values and environment

Material	PA, CR, TPE [1]
Weight	
	Net 2 kg
Ambient temperature	-5 ... 60 °C
Degree of protection	IP54
Mechanical life	1 x 10 ⁶
Switching principle	Snap-action contact element
Number of changeover contacts	3 [2]
Connection	Flying lead
Cable length	
	coiled 5 m

Electrical connection ratings

Rated conditional short-circuit current	100 A
Utilization category according to EN 60947-5-1	
	DC-13 24V 1A [3] 24V 0.3A [4]
Short circuit protection according to IEC 60269-1	2A gG [5]
Rated insulation voltage U _i	250 V
Rated impulse withstand voltage U _{imp}	1,5 kV
Degree of contamination (external, according to EN 60947-1)	3
Connecting cable	12x0.14mm ² [6]
Switching characteristics	3-stage enabling switch

Miscellaneous

Additional feature	
	Pushbutton + 1 [7]
	Pushbutton - 1 [8]
	Selector switch 12 positions 1 [9]
in compliance with	60947-5-8

Reliability values acc. to EN ISO 13849-1

	Enabling switch
B10 _D	$0,1 \times 10^6$

[1] PAK arm

[2, 7, 8, 9] Connection as per block diagram

[3] For enabling switch S4

[4] For additional devices

[5] In case of operating voltages other than 24 V, the short circuit protection must be dimensioned accordingly and checked.

[6] Screened

Dimension drawing

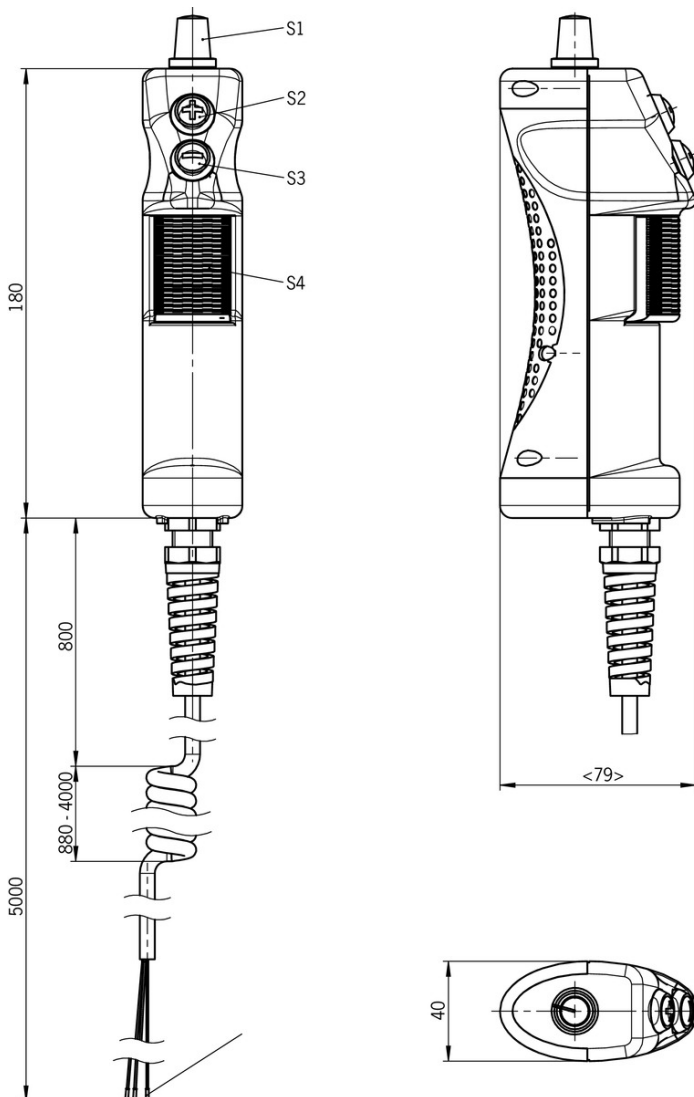

Switching element

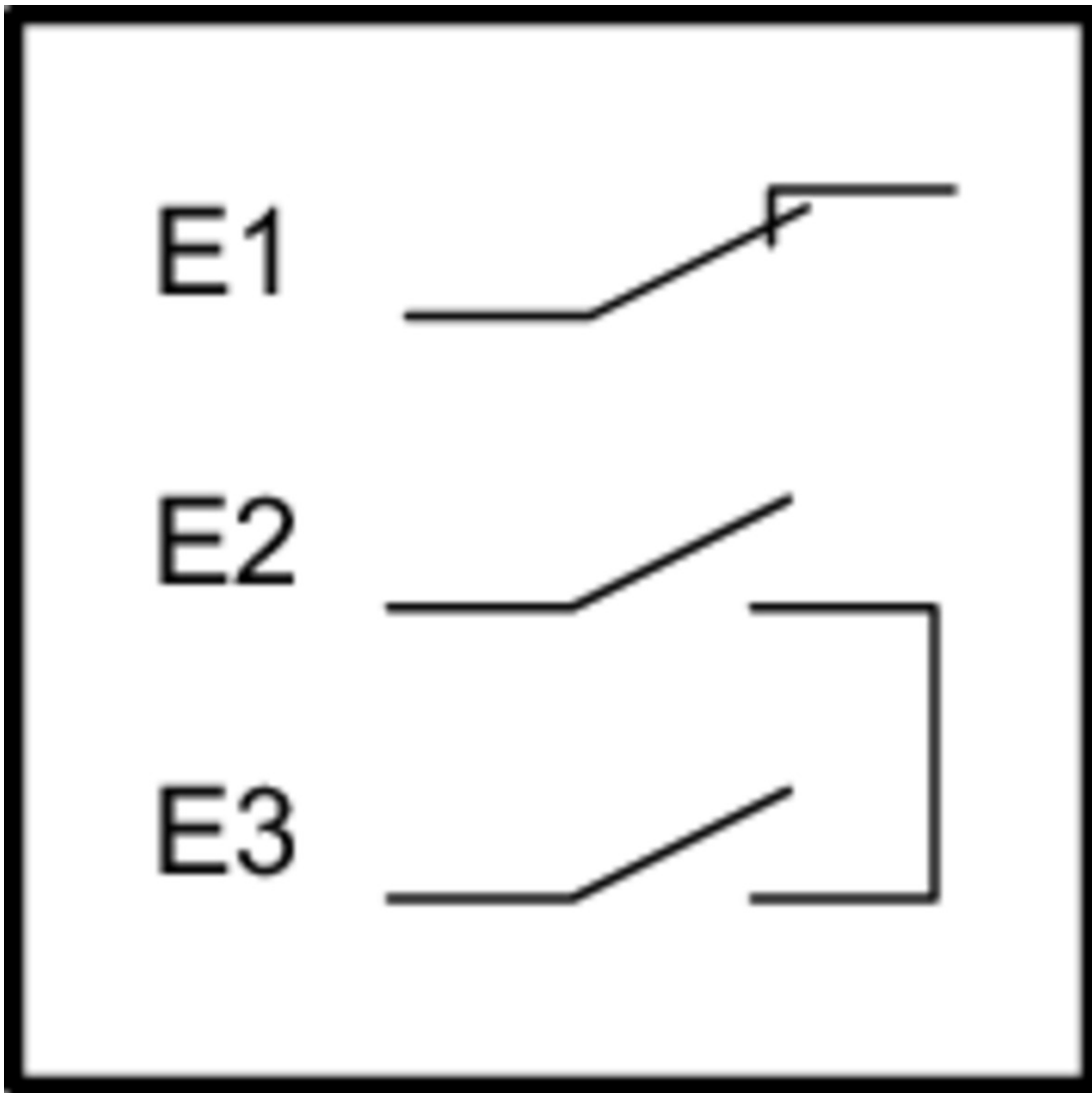

Function sequence

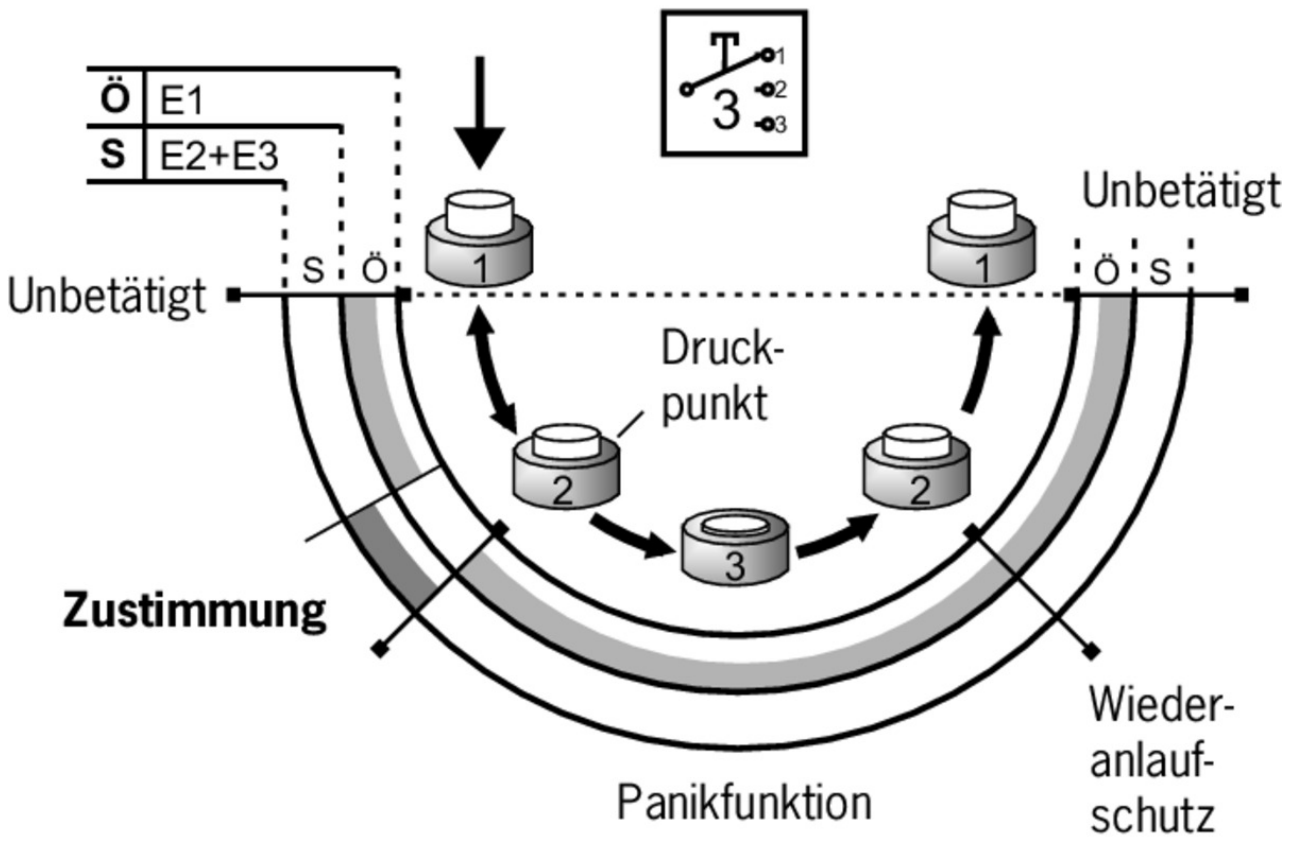

Wiring diagram

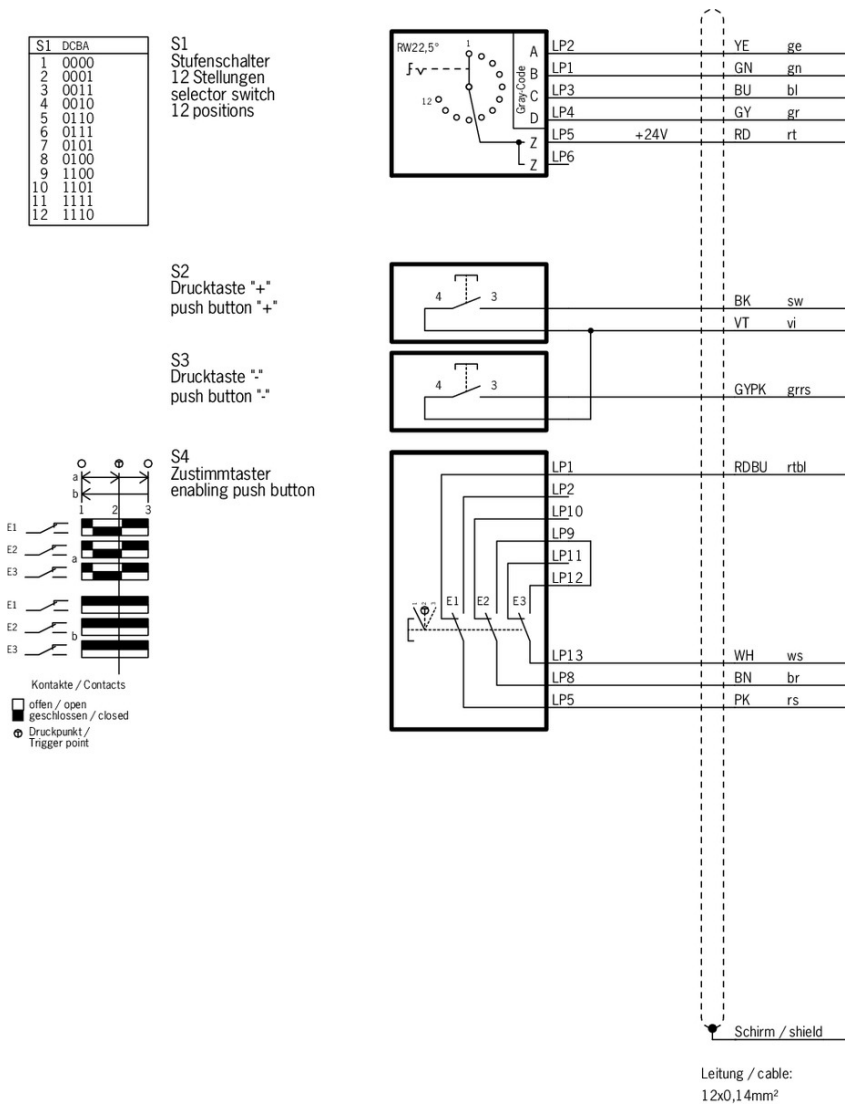

Mounting accessories

✓ Holder for ZSM



102969 HALTER ZSM



102965 HALTER MIT MAGNET ZSM

Connection material

✓ Flange connector RC12 for front wall mounting for the connection of hand-held and P20 enabling switches

073290 RC-12S1N1223ZZ

- Plug connector RC12 for connection, e.g. to enabling switches



073294 RC-12P1N8A8096

- Blanking plug RC12 for covering the flange connector RC12, coded

073291 RC-12P1N8A8300 CODIERT

- Blanking plug RC12 for covering the flange connector RC12

073293 RC-12P1N8A8300

Instructions

- Betriebsanleitung Zustimmtaster ZSM

	Doc. no.	Version	Language	Download
Betriebsanleitung Zustimmtaster ZSM Manual de instrucciones del pulsador de validación ZSM Mode d'emploi de la commande d'assentiment ZSM Operating Instructions Enabling Switch ZSM	098540	05-08/11	 	0.7 MB
Návod k použití potvrzovacího tlačítka ZSM	098540	05-08/11		0.3 MB
Istruzioni di impiego del pulsante di consenso ZSM	098540	05-08/11		0.2 MB
Manual de instruções da chave enable ZSM	098540	05-08/11		0.2 MB
Instrucțiuni de utilizare pentru butonul de activare ZSM	098540	05-08/11		0.3 MB

Catalogs







- Enabling switches ZS Commandes d'Assentiment ZS Zustimmtaster ZS

	Doc. no.	Version	Language	Download
Zustimmtaster ZS	095689	08-07/18		9.1 MB
Commandes d'Assentiment ZS	097367	08-07/18		4.9 MB
Enabling switches ZS	095690	08-07/18		4.9 MB

Declaration of conformity

- EU-Konformitätserklärung

Doc. no.	Version	Language	Download
----------	---------	----------	----------

EU-Konformitätserklärung	2109392	04-11/16		 0.2 MB
Declaración UE de conformidad				
Déclaration UE de conformité				
Dichiarazione di conformità				
EU declaration of conformity				

CAD data

CAD data for this item on TraceParts