

## ITEM 106670 ZSM2300-106670

Description	Technical data	Accessories	Downloads
-------------	----------------	-------------	-----------



### Features

- › 3-stage function
- › Vibration signal
- › LED indicator
- › Reset button ©
- › + and - buttons
- › Coiled connection cable, 3.1 m
- › Plug connector

### 3-stage function

Enabling function is active only in the second stage (middle position, actuating point). If the pushbutton is released or pushed further (panic function), the enabling is removed (dependent on the wiring, see function sequence).

### Vibration signal

The vibration signal is used for tactile feedback of the enabling position.

### LED indicator

The LED indicator is used for visual feedback directly at the enabling switch.

---

### Reset button ©

Button for reset function directly from the enabling switch.

---

### + and - buttons

These buttons can be configured individually. For example for moving axes in the positive or negative direction.

---

### Cable

The high-quality connection cables are available in a coiled version.

### Approvals



### Mechanical values and environment

Material	PA, CR, TPE [1]
Weight	Net 2 kg
Ambient temperature	-5 ... 60 °C
Degree of protection	IP54
Mechanical life	1 x 10 <sup>6</sup>
Switching principle	Snap-action contact element
Number of changeover contacts	3 [2]
Connection	Plug connector number of pins 17 + PE
Cable length	
Coiled, short straight piece of cable on the enabling switch	3,1 m

### Electrical connection ratings

Rated conditional short-circuit current	100 A
Utilization category according to EN 60947-5-1	
DC-13	24V 1A [3] 24V 0.3A [4] 24V 0.01A [5]
Short circuit protection according to IEC 60269-1	2A gG [6]
Rated insulation voltage U <sub>i</sub>	250 V
Rated impulse withstand voltage U <sub>imp</sub>	1,5 kV

Degree of contamination (external, according to EN 60947-1)	3
Connecting cable	18x0.25mm <sup>2</sup>
Switching characteristics	3-stage enabling switch

### Miscellaneous

Additional feature	
Vibration motor	1 [7]
Pushbutton +	1 [8]
Pushbutton -	1 [9]
LED red/green	1 [10]
Pushbutton labeled blue	1 [11]
in compliance with	60947-5-8

### Reliability values acc. to EN ISO 13849-1

	Enabling switch
B10 <sub>D</sub>	0,1 x 10 <sup>6</sup>

[1] PAK arm

[2, 7, 8, 9, 10, 11] Connection as per block diagram

[3] For enabling switch S4

[4] For additional devices

[5] For additional indicators

[6] In case of operating voltages other than 24 V, the short circuit protection must be dimensioned accordingly and checked.

Dimension drawing

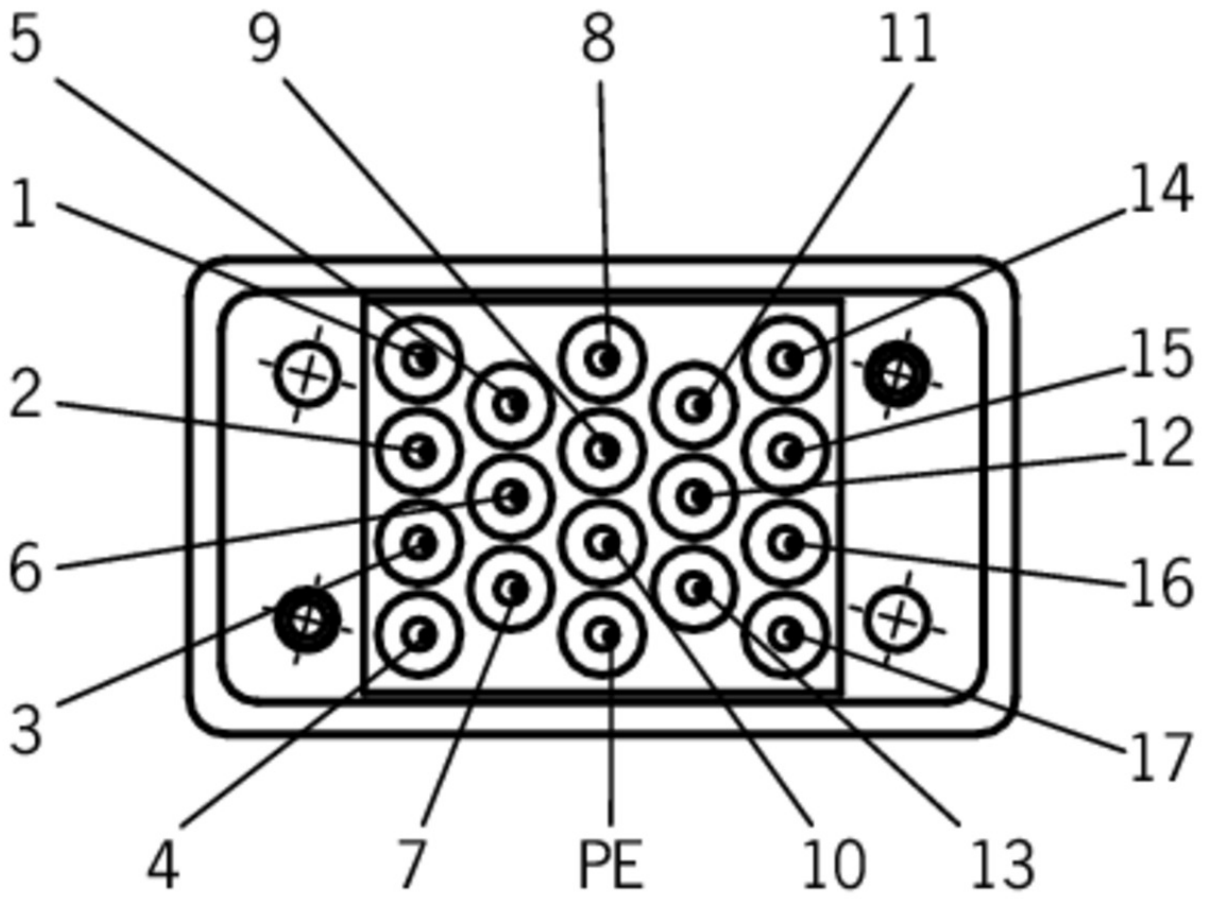

# Dimension drawing

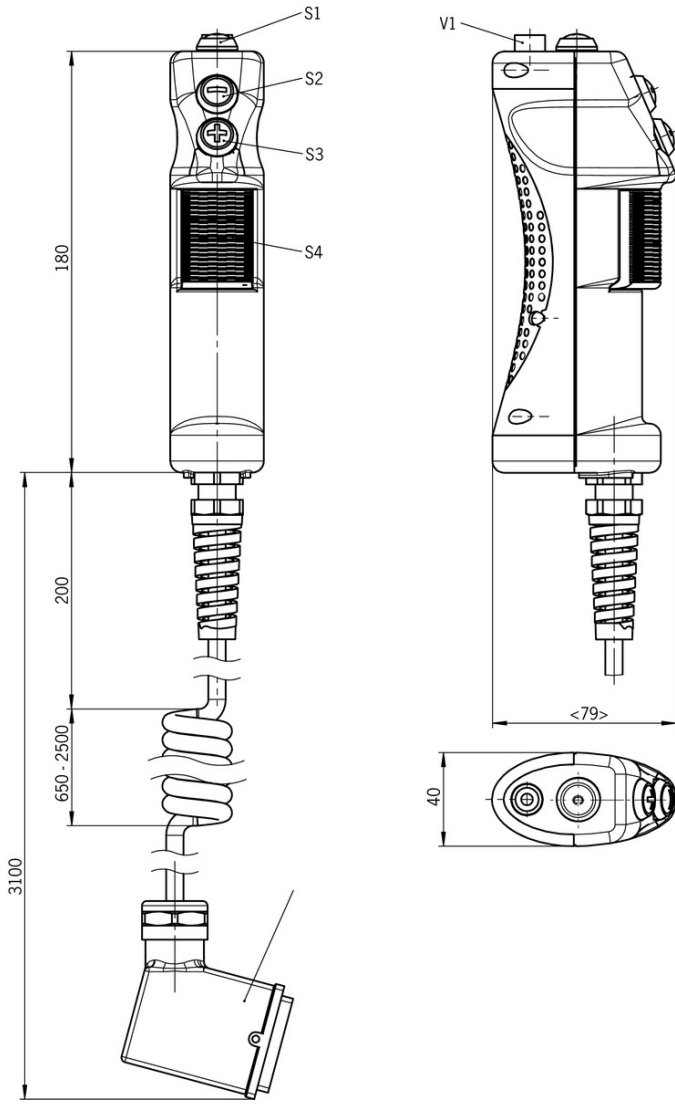

Switching element

E2



E3



Function sequence

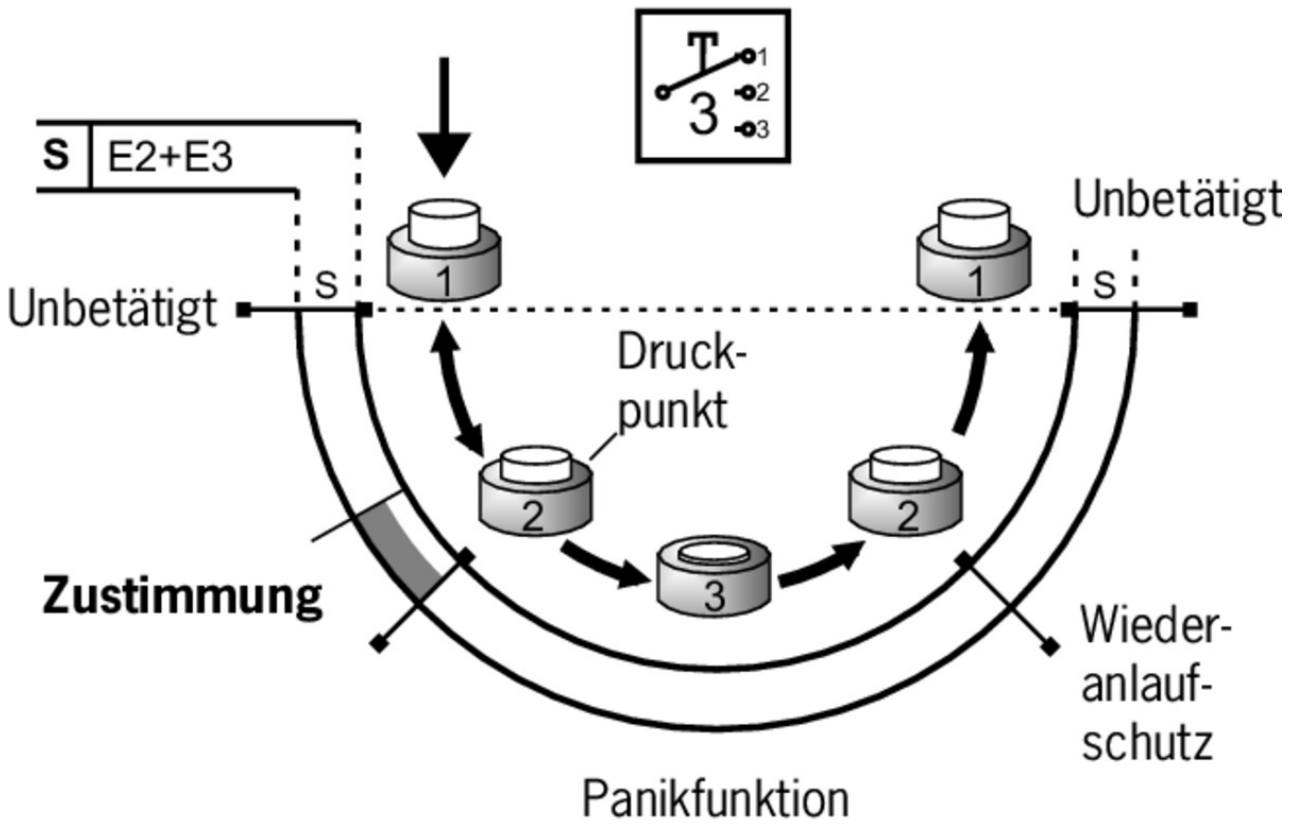

## Wiring diagram

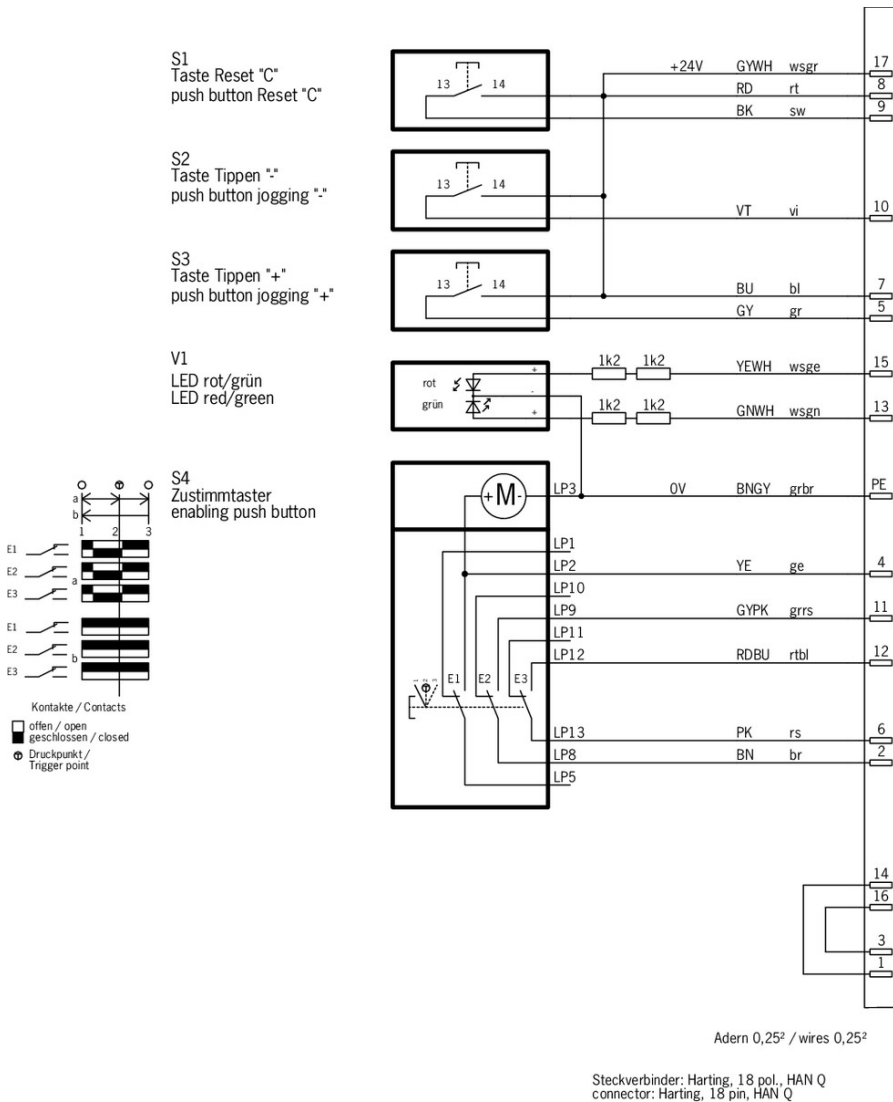

## Mounting accessories

### Holder for ZSM



**102969** HALTER ZSM









**102965** HALTER MIT MAGNET ZSM

## Instructions



### Istruzioni di impiego del pulsante di consenso ZSM



Betriebsanleitung Zustimmtaster ZSM Manual de instrucciones del pulsador de validación ZSM Mode d'emploi de la commande d'assentiment ZSM Operating Instructions Enabling Switch ZSM	098540	05-08/11	   	 0.7 MB
Istruzioni di impiego del pulsante di consenso ZSM	098540	05-08/11		 0.2 MB
Návod k použití potvrzovacího tlačítka ZSM	098540	05-08/11		 0.3 MB
Manual de instruções da chave enable ZSM	098540	05-08/11		 0.2 MB
Instrucțiuni de utilizare pentru butonul de activare ZSM	098540	05-08/11		 0.3 MB







## Catalogs

### Enabling switches ZS Commandes d'Assentiment ZS Zustimmtaster ZS

	Doc. no.	Version	Language	Download
Zustimmtaster ZS	095689	08-07/18		 9.1 MB
Commandes d'Assentiment ZS	097367	08-07/18		 4.9 MB
Enabling switches ZS	095690	08-07/18		 4.9 MB

## Declaration of conformity

### EU-Konformitätserklärung

	Doc. no.	Version	Language	Download
EU-Konformitätserklärung Declaración UE de conformidad Déclaration UE de conformité Dichiarazione di conformità EU declaration of conformity	2109392	04-11/16	    	 0.2 MB