

ITEM 112803 ZSM2300-112803

Description	Technical data	Accessories	Downloads
-------------	----------------	-------------	-----------



Features

- › 3-stage function
- › Vibration signal
- › LED indicator
- › + and - buttons
- › Alternative wiring
- › Coiled connection cable, 9.8 m

3-stage function

Enabling function is active only in the second stage (middle position, actuating point). If the pushbutton is released or pushed further (panic function), the enabling is removed (dependent on the wiring, see function sequence).

Vibration signal

The vibration signal is used for tactile feedback of the enabling position.

LED indicator

The LED indicator is used for visual feedback directly at the enabling switch.

+ and - buttons

These buttons can be configured individually. For example for moving axes in the positive or negative direction.

Cable

The high-quality connection cable is available in a coiled version.

Approvals



Mechanical values and environment

Material	PA, CR, TPE [1]
Weight	Net 2 kg
Ambient temperature	-5 ... 60 °C
Degree of protection	IP54
Mechanical life	1 x 10 ⁶
Switching principle	Snap-action contact element
Number of changeover contacts	3 [2]
Connection	Flying lead
Cable length	9,8 m
Coiled, short straight piece of cable on the enabling switch	

Electrical connection ratings

Rated conditional short-circuit current	100 A
Utilization category according to EN 60947-5-1	DC-13 24V 1A [3] 24V 0.3A [4] 24V 0.01A [5]
Short circuit protection according to IEC 60269-1	2A gG [6]
Rated insulation voltage U _i	250 V
Rated impulse withstand voltage U _{imp}	1,5 kV
Degree of contamination (external, according to EN 60947-1)	3
Connecting cable	12x0.14mm ² [7]
Switching characteristics	3-stage enabling switch

Miscellaneous

Additional feature	
Vibration motor	1 [8]
Pushbutton +	1 [9]
Pushbutton -	1 [10]
LED yellow	1 [11]
in compliance with	60947-5-8

Reliability values acc. to EN ISO 13849-1

	Enabling switch
B10 _D	0,1 x 10 ⁶

[1] PAK arm

[2, 8, 9, 10, 11] Connection as per block diagram

[3] For enabling switch S4

[4] For additional devices

[5] For additional indicators

[6] In case of operating voltages other than 24 V, the short circuit protection must be dimensioned accordingly and checked.

[7] Screened

Dimension drawing

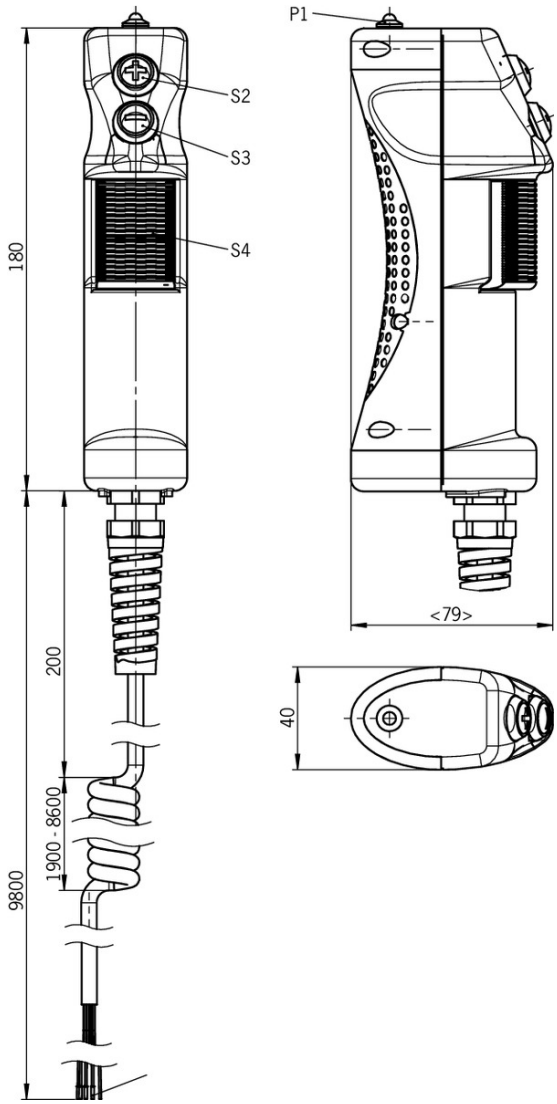

Wiring diagram

S1: "+"
Drucktaste
pushbutton

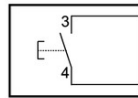

+24V

BK sw

VT vt

S2: "-"
Drucktaste
pushbutton

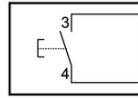

GYPK grrs

V1:
LED gelb
LED yellow

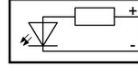

RD rt

S3:
Zustimmtaster
enabling pushbutton

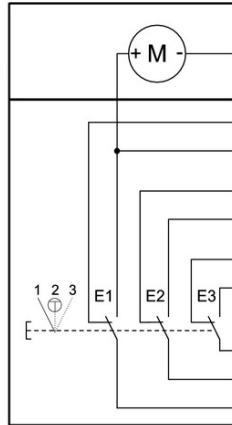

0V

RDBU rtbl

YE ge

PK rs

GY gr

WH ws

BN br

GN gn

BU bl

shield Schirm

Leitung / cable:
12x0,14mm²

Adern nicht belegt/
wires not connected

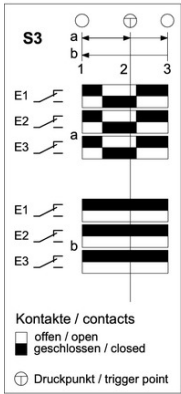

Switching element

E2



E3



Function sequence

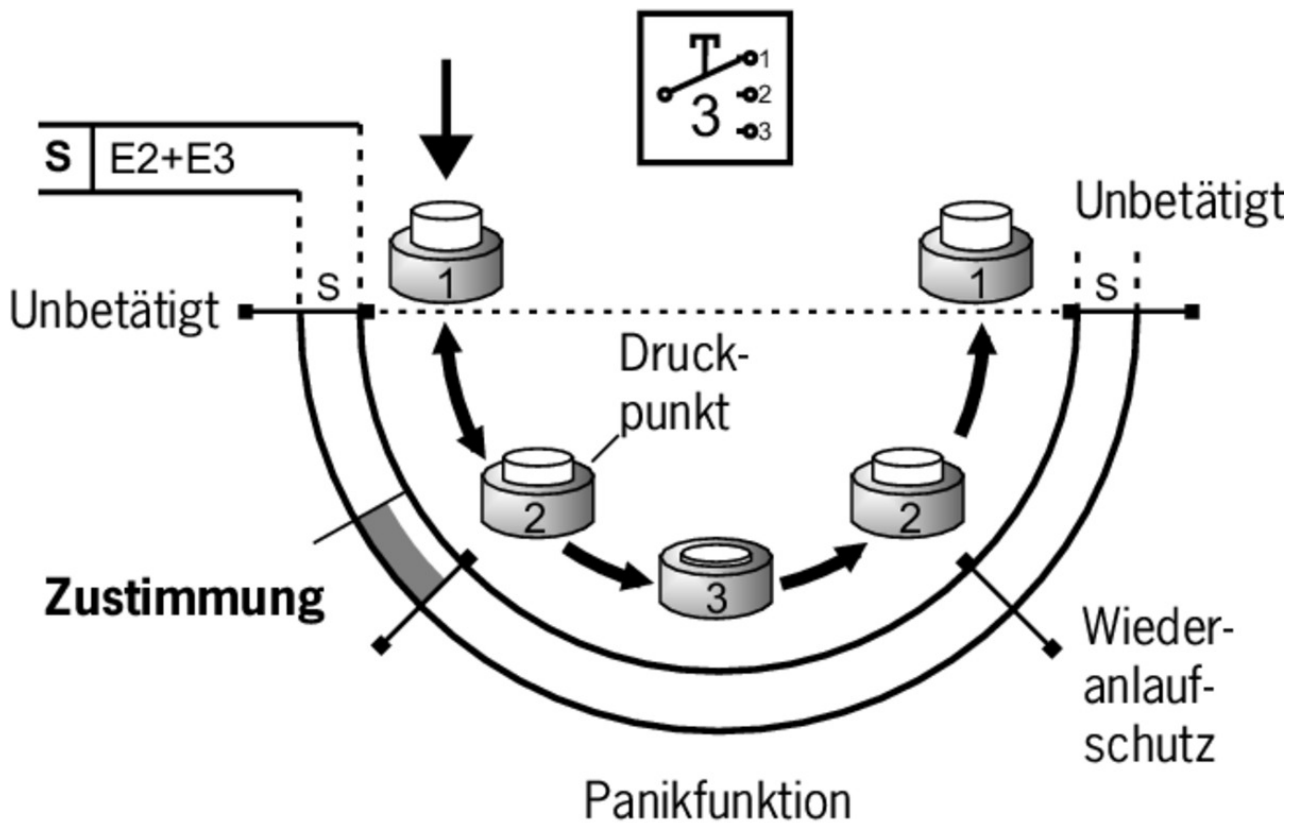

Mounting accessories

- Holder for ZSM



102965 HALTER MIT MAGNET ZSM



102969 HALTER ZSM

Connection material

- Flange connector RC12 for front wall mounting for the connection of hand-held and P20 enabling switches

073290 RC-12S1N1223ZZ

- Plug connector RC12 for connection, e.g. to enabling switches



073294 RC-12P1N8A8096

- Blanking plug RC12 for covering the flange connector RC12, coded

Blanking plug RC12 for covering the flange connector RC12

073293 RC-12P1N8A8300







Instructions

Istruzioni di impiego del pulsante di consenso ZSM

	Doc. no.	Version	Language	Download
Betriebsanleitung Zustimmtaster ZSM Manual de instrucciones del pulsador de validación ZSM Mode d'emploi de la commande d'assentiment ZSM Operating Instructions Enabling Switch ZSM	098540	05-08/11	   	 0.7 MB
Istruzioni di impiego del pulsante di consenso ZSM	098540	05-08/11		 0.2 MB
Manual de instruções da chave enable ZSM	098540	05-08/11		 0.2 MB
Návod k použití potvrzovacího tlačítka ZSM	098540	05-08/11		 0.3 MB
Instrucțiuni de utilizare pentru butonul de activare ZSM	098540	05-08/11		 0.3 MB







Catalogs

Enabling switches ZS Commandes d'Assentiment ZS Zustimmtaster ZS

	Doc. no.	Version	Language	Download
Zustimmtaster ZS	095689	08-07/18		 9.1 MB
Commandes d'Assentiment ZS	097367	08-07/18		 4.9 MB
Enabling switches ZS	095690	08-07/18		 4.9 MB

Declaration of conformity

EU-Konformitätserklärung

	Doc. no.	Version	Language	Download
EU-Konformitätserklärung Declaración UE de conformidad Déclaration UE de conformité Dichiarazione di conformità EU declaration of conformity	2109392	04-11/16	    	 0.2 MB