

ITEM 121290 MSC-CE-AC-FI8FO2-121290

Description	Technical data	Accessories	Downloads
-------------	----------------	-------------	-----------



Features

- › Input and output expansion
- › 8 single-channel /4 dual-channel inputs
- › 2 control inputs
- › 2 semiconductor outputs (PL e, category 4)
- › 2 door monitoring outputs
- › Compact housing with width of only 22.5mm
- › Straightforward diagnostics via LED displays
- › Plug-in screw terminals

Approvals



Mechanical values and environment

Dimensions	108 x 22.5 x 114.5 [1]
------------	------------------------

Material		
	Housing	Polyamide
Ambient temperature		-10 ... +55 °C
Atmospheric humidity		10 ... 95 % rH
Degree of protection		IP20
Mounting method		Mounting rail 35mm [2]
Connection		Plug-in screw terminal [3]
Cable length		max.100 m [4]
		Pulse output 1...4
Number of outputs		4
		Status (can be programmed via software)
Number of monitoring outputs		2
		Safety input 1...8
Number of inputs		8
		External relay monitoring (EDM), automatic, manual operation
Number of inputs		2
		For node selection
Number of inputs		2
		Safety outputs OSSD1, OSSD2
Number of safety outputs		2

Electrical connection ratings

Operating voltage DC		
	UB	24 V DC -20% ... +20% PELV [5]
Overvoltage category according to IEC EN 60664-1		II
Degree of contamination according to EN 60664-1		2
Connection cross-section		0,5 ... 2,5 mm ²
Delay time		0,0106 ... 0,0546 s [6]
Power consumption		max.3 W
		Pulse output 1...4
Test pulses		0,2 ms
Type of output		Semiconductor outputs, p-switching [7]
		Status (can be programmed via software)
Type of output		Semiconductor outputs, p-switching
Output current		max.100 mA
		Safety input 1...8
Type of input		Semiconductor inputs, p-switching [8]
		External relay monitoring (EDM), automatic, manual operation
Type of input		Semiconductor inputs, p-switching [9]
		For node selection

Type of input	Semiconductor inputs, p-switching ^[10]
	Safety outputs OSSD1, OSSD2
Test pulses	0,1 ms
Inductive load	max.30 mH
Capacitive load	max.0,82 µF
Type of output	Semiconductor outputs, p-switching, short circuit-proof
Output voltage	HIGH UB-0,75 ... UB V DC LOW 0 ... 2 V DC
Output current	Max. load at 24VDC - ... 400 mA

Reliability values acc. to EN ISO 13849-1

ESPE type	4 ^[11]
Performance Level	PL e ^[12]
Category	4 ^[13]
PFH _D	5.72E-09 1/h ^[14]
SIL CL	3 ^[15]
Mission time	20 y ^[16]

[1] Including screw terminals

[2] Acc. to EN 60715

[3] Terminals not included

[4] With length above 50m use cross-section >1mm².

[5] Acc. to EN 60204-1

[6] Depending on the number of slave modules, operators and OSSD outputs. (See operating instructions and calculated values in the software "Euchner Safety Designer")

[7, 8, 9] Acc. to EN 61131-2

[10] "Typ2" acc. to EN 61131-2

[11] Acc. to EN 61496-1

[12, 13, 16] Acc. to ISO 13849-1:2006/IEC 62061:2005

[14] Acc. to IEC 61508:2010

[15] Acc. to IEC 62061:2005

Dimension drawing

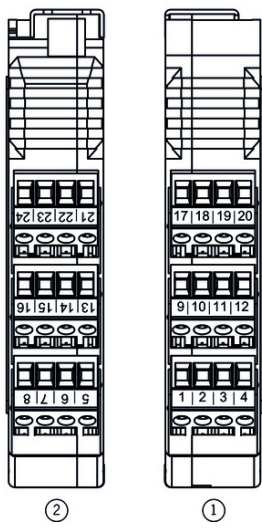
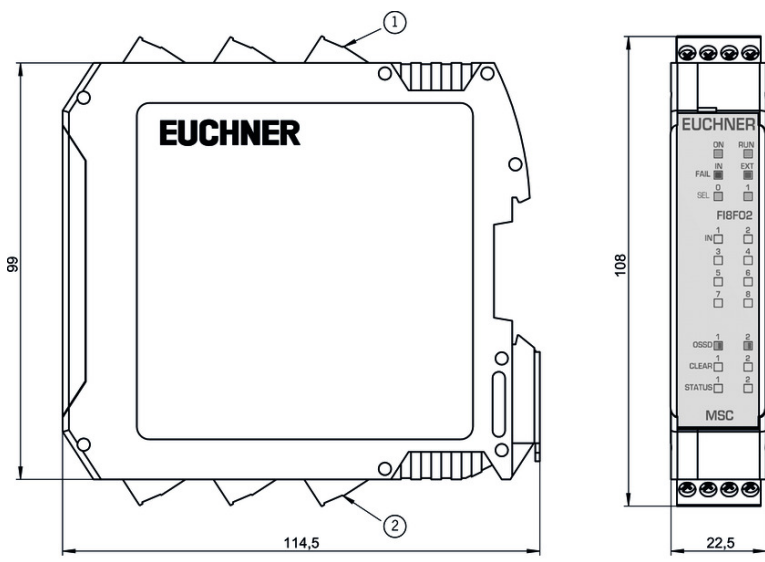

Legende

- 1 Page A
- 2 Page B

Block diagram

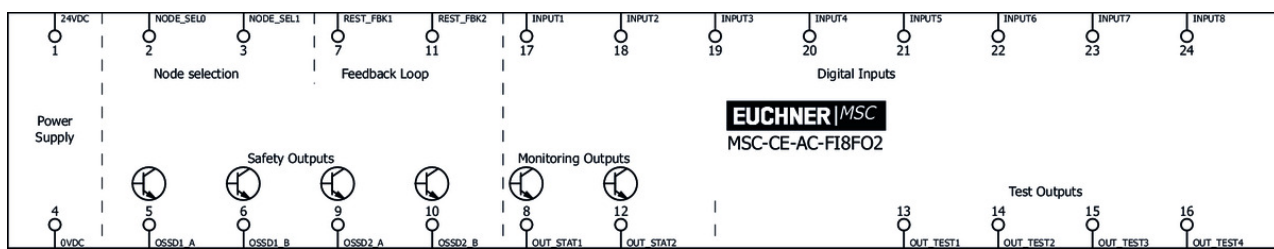

Connection material

Terminal set 6 contacts, screw terminals



121321 AC-SC-04-V06-121321

Features

› Plug-in screw terminals

Expansion connector, MSC



121308 AC-PL-B-121308

Instructions

MODULARE SICHERHEITSSTEUERUNG MSC Installation und Verwendung

	Doc. no.	Version	Language	Download
MODULARE SICHERHEITSSTEUERUNG MSC Installation und Verwendung	121331	03-05/16		5.9 MB
AUTOMATE INTÉGRÉ DE SÉCURITÉ MODULAIRE MSC Installation et utilisation	121331	03-05/16		6.2 MB
MODULAR SAFETY INTEGRATED CONTROLLER MSC Instalación y uso	121331	03-05/16		6.2 MB
MODULAR SAFETY INTEGRATED CONTROLLER MSC Installation and use	121331	03-05/16		6.2 MB
SISTEMA DI CONTROLLO MODULARE DI SICUREZZA MSC Installazione e uso	121331	03-05/16		6.1 MB

MSC FI8FO2 E/A-ERWEITERUNGSMODUL

	Doc. no.	Version	Language	Download
MSC FI8FO2 E/A-ERWEITERUNGSMODUL MSC FI8FO2 I/O EXPANSION MODULE	121336	02-10/14	 	1.5 MB









TECHNISCHES DATENBLATT Erweiterungsmodule

	Doc. no.	Version	Language	Download
TECHNISCHES DATENBLATT Erweiterungsmodule DOCUMENTO TÉCNICO módulos de expansión FICHE TECHNIQUE modules d'extension FOGLIO TECNICO moduli di espansione TECHNICAL SHEET expansion units	121345	02-02/16	 	1.1 MB

Catalogs

Einfach programmierbar - Die sichere Kleinststeuerung MSC Easily programmable - The small safe control system MSC Simplement programmable - L'automate de sécurité MSC Fácil de programar - El controlador seguro de tamaño reducido MSC 易于编程 - MSC小型安全控制系统

	Doc. no.	Version	Language	Download
Einfach programmierbar - Die sichere Kleinststeuerung MSC	121780	05-05/16		2.2 MB

Simplement programmable - L'automate de sécurité MSC	122111	05-05/16		 2.2 MB
Fácil de programar - El controlador seguro de tamaño reducido MSC	122112	05-05/16		 2.2 MB
Easily programmable - The small safe control system MSC	121888	05-05/16		 2.2 MB
易于编程 - MSC小型安全控制系统	157058	05-05/16		 2.7 MB