

ITEM 106435 ES-XA1E-BV3U02R

Description	Technical data	Accessories	Downloads
-------------	----------------	-------------	-----------



Features

- › With turn-to-reset
- › Bottom of housing yellow
- › Button head red ø 29 mm
- › Emergency stop device according to ISO 13850

Two-channel emergency stop device (red, with pull-to-reset button and turn-to-reset button) for installation in housing ZSM/HBA/HBM, for different wiring concepts.

Notes

- › The EMERGENCY STOP device engages when actuated by pressing, unlocks when turned or pulled, and is tamper proof

Switching element

- › 2 NC \ominus

Approvals

Mechanical values and environment

Material	Button	Fiber glass reinforced thermoplastic
	Housing	Polycarbonate
Ambient temperature		-25 ... 60 °C
Degree of protection		IP65
Mechanical life		0,25 x 10 ⁶
Contact material		Silver alloy, gold flashed
Mounting method		IEC 947-5-1 D16
Number of positively driven contacts		2
Connection		Soldered connection

Electrical connection ratings

Rated thermal current I _{th}		1 A
Utilization category according to EN 60947-5-1	DC-13	3A 24V
Rated insulation voltage U _i		250 V
Switching current	Min. at 24V	10 mA

Miscellaneous

Additional feature		Button head Ø 29 mm
		Reset by pulling or turning
		Short design
Color	Actuating button	Red
	Bottom part	Yellow

Reliability values acc. to EN ISO 13849-1

B10 _D		0,1 x 10 ⁶
------------------	--	-----------------------

Dimension drawing

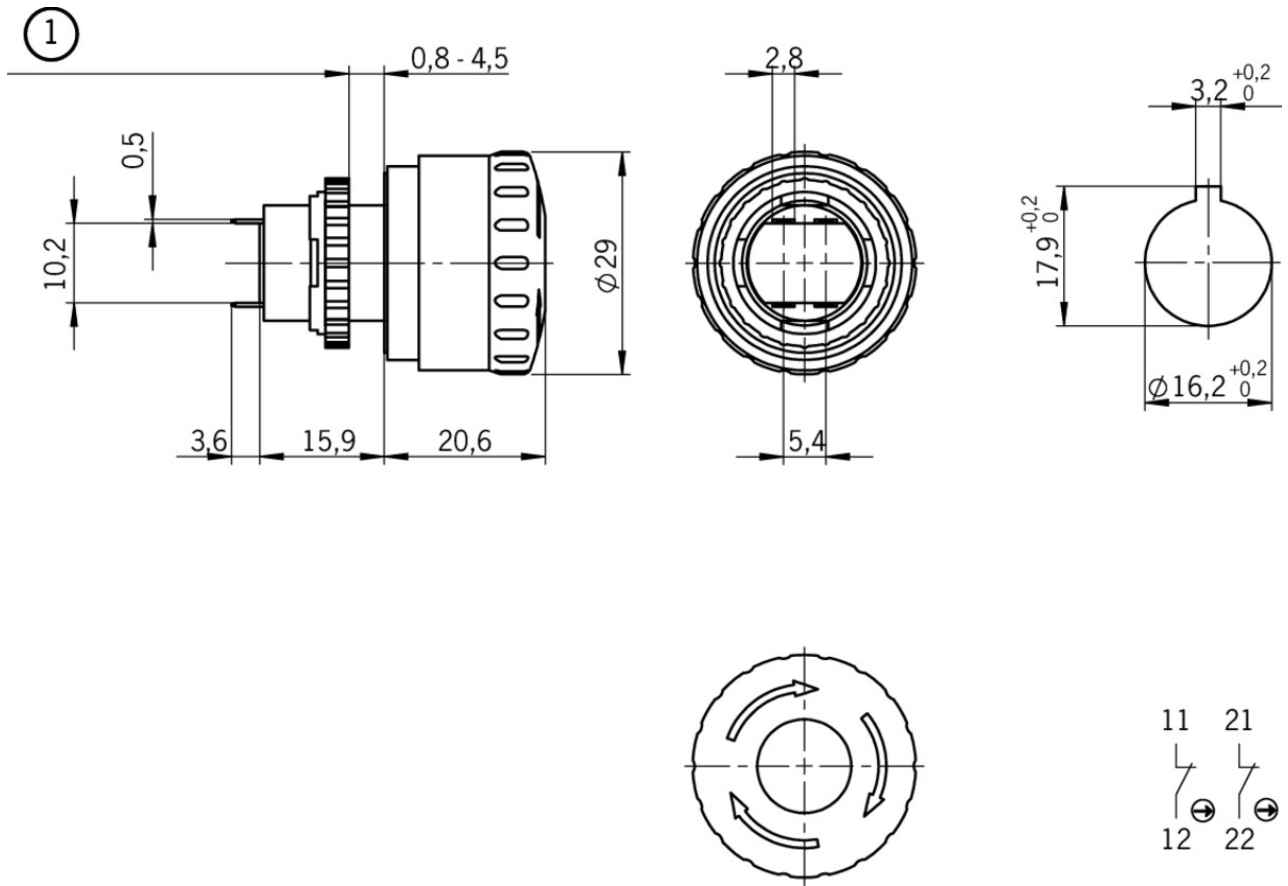

Legende

1 Front panel thickness

Switching functions

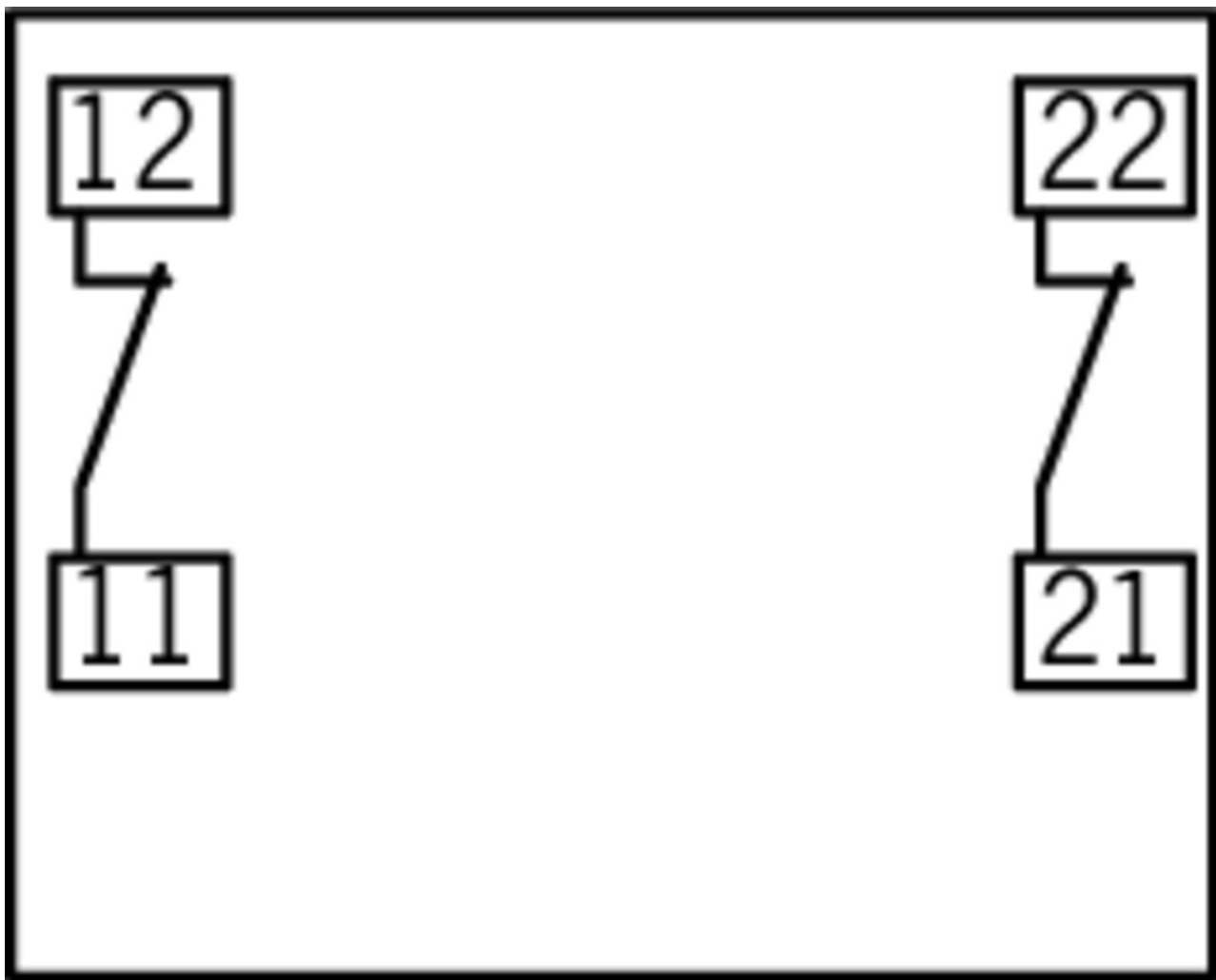

Mounting accessories

Key for emergency stop ES-XA

106339 ES-MT-001

Features

- › Key for fastening the ring screw on ES-XA... devices

Sign for emergency stop ES-XA





106342 ES-HAAV-27

Features

- › Key for fastening the ring screw on ES-XW... devices









Instructions

▼ Betriebsanleitung Not-Aus-Schalter ES-XA







	Doc. no.	Version	Language	Download
Betriebsanleitung Not-Aus-Schalter ES-XA Operating Instructions Emergency Stop Switch ES-XA	2512320	01-02/18	 	 0.4 MB

Catalogs

▼ Not-Halt-Geräte/Seilzugschalter Emergency Stop Devices/Rope Pull Switches Dispositifs d'arrêt d'urgence/interrupteurs à câble Dispositivos de parada de emergencia / Interruptores de accionamiento por cable

	Doc. no.	Version	Language	Download
Not-Halt-Geräte/Seilzugschalter	106210	06-06/16		 1.9 MB
Dispositifs d'arrêt d'urgence/interrupteurs à câble	116529	06-06/16		 1.9 MB
Dispositivos de parada de emergencia / Interruptores de accionamiento por cable	116530	06-06/16		 1.9 MB
Emergency Stop Devices/Rope Pull Switches	116448	06-06/16		 1.9 MB

▼ Handbediengeräte/Handräder Hand-Held Pendant Stations/Handwheels Pupitres portables/Manivelles







	Doc. no.	Version	Language	Download
Handbediengeräte/Handräder	098619	08-09/17		 3.0 MB
Pupitres portables/Manivelles	111529	08-09/17		 3.0 MB
Hand-Held Pendant Stations/Handwheels	099443	08-09/17		 3.0 MB

▼ Enabling switches ZS Commandes d'Assentiment ZS Zustimmungstaster ZS

	Doc. no.	Version	Language	Download
Zustimmungstaster ZS	095689	08-07/18		 9.1 MB
Commandes d'Assentiment ZS	097367	08-07/18		 4.9 MB
Enabling switches ZS	095690	08-07/18		 4.9 MB

Declaration of conformity

▼ EU-Konformitätserklärung

	Doc. no.	Version	Language	Download
EU-Konformitätserklärung Declaración UE de conformidad Déclaration UE de conformité Dichiarazione di conformità EU declaration of conformity	2105755	08-03/17	    	 0.2 MB

CAD data

CAD data for this item on TraceParts