

ITEM 105013 ES-XW1E-BV412MFR

Description	Technical data	Accessories	Downloads
-------------	----------------	-------------	-----------



Features

- › Button head red 40 mm ø
- › Contact block monitoring
- › Reset by pulling or turning

Switching element

- › 2 NC \ominus + 1 NO

Approvals



Mechanical values and environment

Material	Button	Fiber glass reinforced thermoplastic
----------	--------	--------------------------------------

Housing	Polycarbonate
Ambient temperature	-25 ... 60 °C
Degree of protection	IP20
Mechanical life	0,25 x 10 ⁶
Contact material	Silver alloy, gold flashed
Mounting method	IEC 947-5-1 D22
Number of positively driven contacts	2
Number of NO contacts	1
Connection	Screw terminal

Electrical connection ratings

Rated thermal current I _{th}	1 A
Utilization category according to EN 60947-5-1	AC-15 1.5 A 250 V DC-13 1A 30V AC-14 0.3 A 250 V
Rated insulation voltage U _i	250 V
Switching current	Min. at 24V 10 mA

Miscellaneous

Additional feature	Button head Ø 40 mm Reset by pulling or turning Contact block monitoring
Color	Actuating button Red Bottom part Yellow

Reliability values acc. to EN ISO 13849-1

B10 _D	0,1 x 10 ⁶
------------------	-----------------------

Dimension drawing

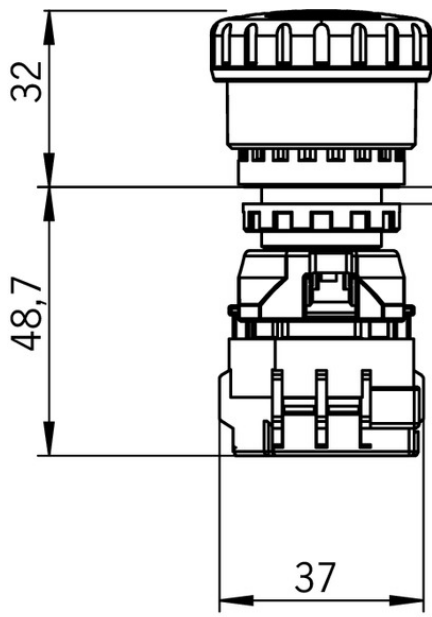

0,5 ... 3,7
Schalttafelstärke
Panel thickness

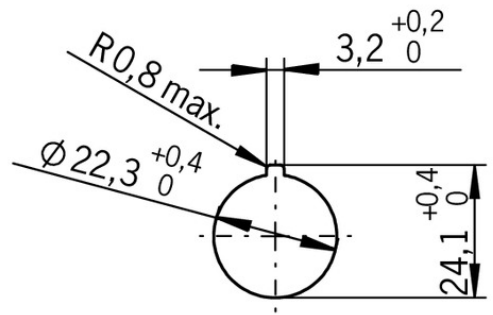
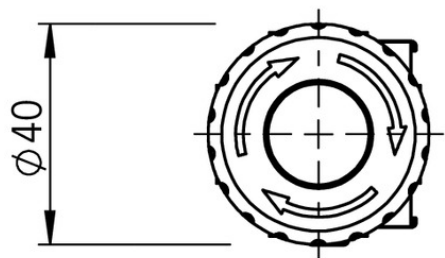
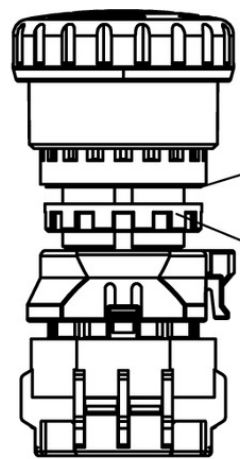

Schalttafelauausschnitt
Panel cut-out

Switching functions

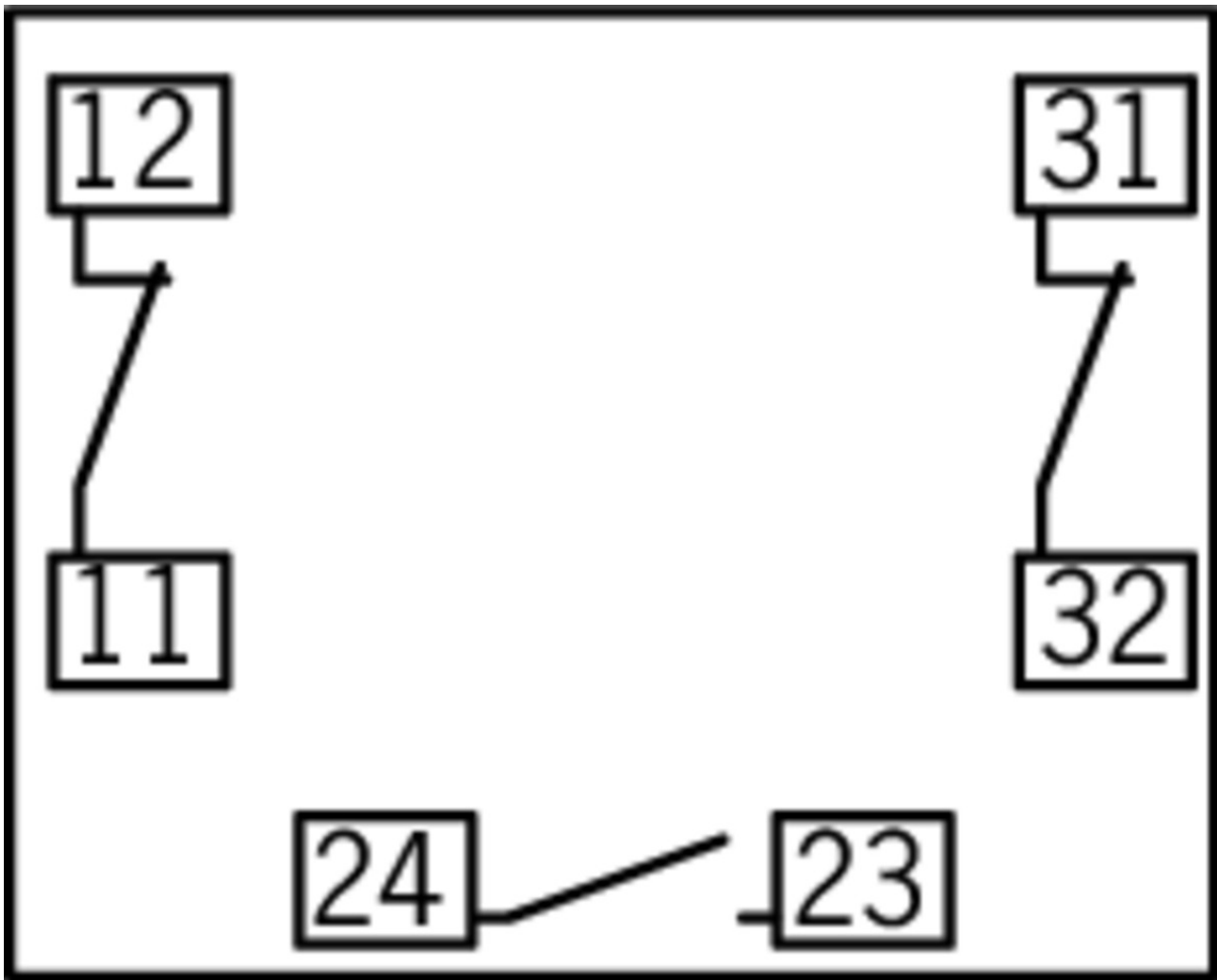

Mounting accessories

Key for emergency stop ES-XW

106337 ES-MW9Z-T1

Features

- › Key for fastening the ring screw on ES-XW... devices

Sign for emergency stop ES-XW



106340 ES-HWAV-27

Features

- › Emergency stop label for 40 mm buttons on ES-XW devices with text "Emergency Stop"

Sign for emergency stop ES-XA





106342 ES-HAAV-27

Features

- › Key for fastening the ring screw on ES-XW... devices









Instructions

▼ Betriebsanleitung Not-Aus-Schalter ES-XW/XN

	Doc. no.	Version	Language	Download
Betriebsanleitung Not-Aus-Schalter ES-XW/XN Operating Instructions Emergency Stop Switch ES-XW/XN	2105026	11-06/17	 	 1.3 MB







Catalogs

▼ Not-Halt-Geräte/Seilzugschalter Emergency Stop Devices/Rope Pull Switches Dispositifs d'arrêt d'urgence/interrupteurs à câble Dispositivos de parada de emergencia / Interruptores de accionamiento por cable

	Doc. no.	Version	Language	Download
Not-Halt-Geräte/Seilzugschalter	106210	06-06/16		 1.9 MB
Dispositifs d'arrêt d'urgence/interrupteurs à câble	116529	06-06/16		 1.9 MB
Dispositivos de parada de emergencia / Interruptores de accionamiento por cable	116530	06-06/16		 1.9 MB
Emergency Stop Devices/Rope Pull Switches	116448	06-06/16		 1.9 MB

Declaration of conformity

▼ EU-Konformitätserklärung

	Doc. no.	Version	Language	Download
EU-Konformitätserklärung Declaración UE de conformidad Déclaration UE de conformité Dichiarazione di conformità EU declaration of conformity	2105755	08-03/17	    	 0.2 MB