

ITEM 094087 RPS3131SC300BHA10LL024

| Description | Technical data | Accessories | Downloads |
|-------------|----------------|-------------|-----------|
|-------------|----------------|-------------|-----------|



Features

- › Plastic housing
- › Emergency stop device with detent mechanism according to EN ISO 13850 and EN 60204-1
- › Clamping head for pull rope
- › Indication of correct rope tension
- › Plug connector MR10
- › LED left
- › Switching elements with 4 switching contacts
- › Emergency stop

Switching element

3131 Slow-action switching contact 2 NC \ominus + 2 NO

Approvals

Mechanical values and environment

| | |
|--------------------------------------|-------------------------------|
| Housing material | Reinforced thermoplastic |
| Weight | |
| | Net 0,8 kg |
| Ambient temperature | -20 ... 50 °C |
| Degree of protection | IP65 |
| Mechanical life | 0,1 x 10 ⁶ |
| Switching principle | Slow-action switching contact |
| Rope diameter | 2 ... 5 mm |
| Installation position | Any |
| Number of positively driven contacts | 2 |
| Number of NO contacts | 2 |
| Connection | Plug connector MR10 [1] |
| Actuating force | 300 N |

Electrical connection ratings

| | |
|---|------------------|
| Rated thermal current I_{th} | 4 A |
| Utilization category according to EN 60947-5-1 | |
| | AC-15 3A 50V |
| Short circuit protection according to IEC 60269-1 | |
| | (Fuse) 4A gG |
| Rated insulation voltage U_i | 50 V |
| Rated impulse withstand voltage U_{imp} | 2,5 kV |
| Switching current | |
| | at 24V min.10 mA |
| LED indicator | |
| | DC 24 V [2] |

Miscellaneous

| | |
|--------------------|-------------------------|
| Additional feature | Emergency stop function |
|--------------------|-------------------------|

[1] 10-pin (without PE) - bottom

[2] Left switches red LED

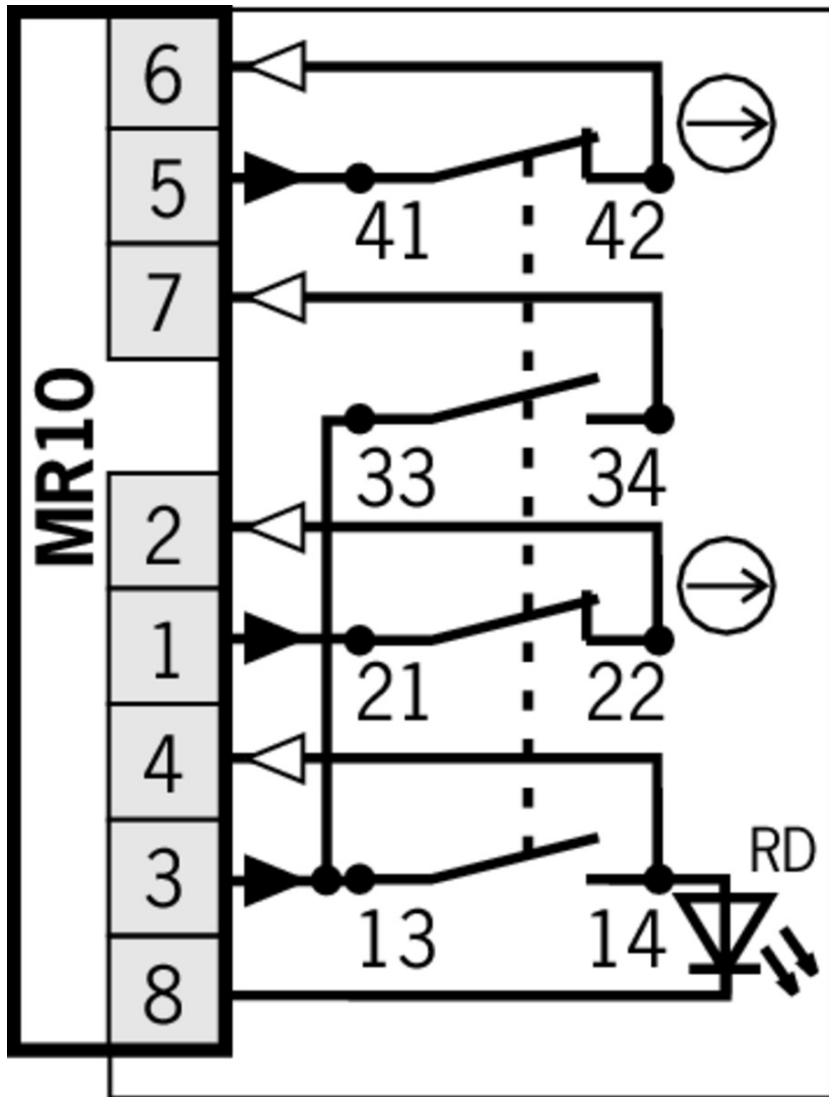

Travel diagram

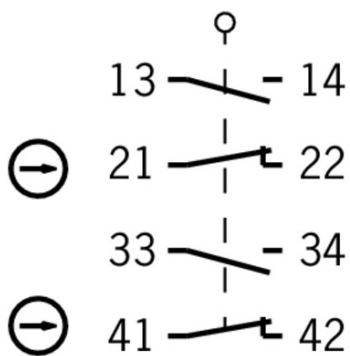
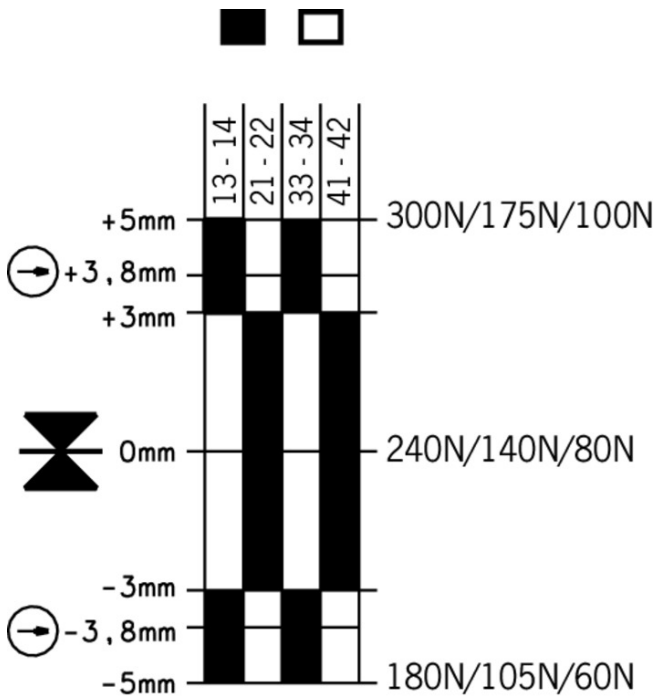

Mounting accessories

- ▼ Eyebolt for rope pull switches

092495 RPS-O-8-50/V5

- ▼ Features

- › Eyebolt with thread M8

- ▼ Rope set for rope pull switches

092496 RPS-RS/V5

- ▼ Features

- › Rope set consisting of thimble and rope clamp

- ▼ Pulley set RPS-PS/V5 for rope pull switches



092501 RPS-PS/V5

- ▼ Features

- › Pulley set consisting of rope pulley block and pulley support
-

▼ Pulley set RPS-P/V1 for rope pull switches



096251 RPS-P-7-70

▼ Features

- › Pulley Ø 14mm
-

▼ Turnbuckle for rope pull switches

092498 RPS-B-6-60/V5

▼ Features

- › Turnbuckle M6 x 60
-

092500 RPS-B-6-110

▼ Features

- › Turnbuckle M6 x 100
-

▼ Tensioner spring for rope pull switches



092138 RPS-W-300

▼ Features

- › Tensioner spring for tensile force 300 N
-

▼ Tensioning rope for rope pull switches



092813 RPS-I-3-4/50M

▼ Features

- › Tensioning rope with 50m length
-



092814 RPS-I-3-4/100M

▼ Features

- › Tensioning rope with 100m length
-

Function expansion

▼ Built-in LED



087423 EINBAULEUCHTE LED M20X1,5



095510 EINBAULEUCHTE LED-F M20X1,5

Connection material

-
- ✓ Connection cables with plug connector MR10, 10-pin, 1.8m



100949 C-MINF10-10X1,0PV01,8-MA-100949

✓ Features

- › MR10 female plug, 10-pin
 - › Straight plug connector
 - › PVC cable
 - › Cable length 1.8 m
 - › With flying lead
-

- ✓ Connection cable with plug connector MR10, 10-pin, 15.2m



100953 C-MINF10-10X1,0PV15,2-MA-100953

✓ Features

- › MR10 female plug, 10-pin
 - › Straight plug connector
 - › PVC cable
 - › Cable length 15.2 m
 - › With flying lead
-



102520 C-MINF10-10X1,0PU15,2-MA-102520

✓ Features

- › MR10 female plug, 10-pin
 - › Straight plug connector
 - › PUR cable
 - › Cable length 15.2 m
 - › With flying lead
-

- ✓ Connection cable with plug connector MR10, 10-pin, 6m



100951 C-MINF10-10X1,0PV06,0-MA-100951

✓ Features

- › MR10 female plug, 10-pin
 - › Straight plug connector
 - › PVC cable
 - › Cable length 6 m
 - › With flying lead
-



102518 C-MINF10-10X1,0PU06,0-MA-102518

✓ Features

- › MR10 female plug, 10-pin
 - › Straight plug connector
 - › PUR cable
 - › Cable length 6 m
 - › With flying lead
-

- ✓ Connection cable with plug connector MR10, 10-pin, 9.1m



100952 C-MINF10-10X1,0PV09,1-MA-100952

✓ Features

- › MR10 female plug, 10-pin
- › Straight plug connector

- › PVC cable
- › Cable length 9.1 m
- › With flying lead



100956 C-MINF10-10X1,0PU09,1-MA-100956

✓ Features

- › MR10 female plug, 10-pin
- › Straight plug connector
- › PUR cable
- › Cable length 9.1 m
- › With flying lead

✓ Connection cable with plug connector MR10, 10-pin, 12.1m



102505 C-MINF10-10X1,0PV12,1-MA-102505

✓ Features

- › MR10 female plug, 10-pin
- › Straight plug connector
- › PVC cable
- › Cable length 12.1 m
- › With flying lead



102519 C-MINF10-10X1,0PU12,1-MA-102519

✓ Features

- › MR10 female plug, 10-pin
- › Straight plug connector
- › PUR cable
- › Cable length 12.1 m
- › With flying lead

✓ Connection cable with plug connector M10, 10-pin, 3.6m



100950 C-MINF10-10X1,0PV03,6-MA-100950

✓ Features

- › MR10 female plug, 10-pin
- › Straight plug connector
- › PVC cable
- › Cable length 3.6 m
- › With flying lead

✓ Connection cable with plug connector MR10, 10-pin, 1.8m



102516 C-MINF10-10X1,0PU01,8-MA-102516

✓ Features

- › MR10 female plug, 10-pin
- › Straight plug connector
- › PUR cable
- › Cable length 1.8 m
- › With flying lead

✓ Connection cable with plug connector MR10, 10-pin, 3.6m



102517 C-MINF10-10X1,0PU03,6-MA-102517

Features

- › MR10 female plug, 10-pin
- › Straight plug connector
- › PUR cable
- › Cable length 3.6 m
- › With flying lead

Connection cable with plug connector MR10, 10-pin, 18.2m



102521 C-MINF10-10X1,0PU18,2-MA-102521

Features

- › MR10 female plug, 10-pin
- › Straight plug connector
- › PUR cable
- › Cable length 18.2 m
- › With flying lead

Instructions

Betriebsanleitung Seilzugschalter RPS...

| | Doc. no. | Version | Language | Download |
|--|----------|----------|----------|----------|
| Betriebsanleitung Seilzugschalter RPS... | 2090276 | 08-01/18 | | 2.7 MB |
| Operating Instructions for Rope Pull Switches RPS... | 2090276 | 08-01/18 | | 2.7 MB |

Catalogs







Not-Halt-Geräte/Seilzugschalter Emergency Stop Devices/Rope Pull Switches Dispositifs d'arrêt d'urgence/interrupteurs à câble Dispositivos de parada de emergencia / Interruptores de accionamiento por cable

| | Doc. no. | Version | Language | Download |
|---|----------|----------|----------|----------|
| Not-Halt-Geräte/Seilzugschalter | 106210 | 06-06/16 | | 1.9 MB |
| Dispositifs d'arrêt d'urgence/interrupteurs à câble | 116529 | 06-06/16 | | 1.9 MB |
| Dispositivos de parada de emergencia / Interruptores de accionamiento por cable | 116530 | 06-06/16 | | 1.9 MB |
| Emergency Stop Devices/Rope Pull Switches | 116448 | 06-06/16 | | 1.9 MB |

Declaration of conformity

EU-Konformitätserklärung

| Doc. no. | Version | Language | Download |
|----------|---------|----------|----------|
|----------|---------|----------|----------|

| | | | | |
|-------------------------------|---------|----------|---|---|
| EU-Konformitätserklärung | 2091952 | 03-04/17 |  |  0.2 MB |
| Declaración UE de conformidad | | |  | |
| Déclaration UE de conformité | | |  | |
| Dichiarazione di conformità | | |  | |
| EU declaration of conformity | | |  | |

CAD data

CAD data for this item on TraceParts