

ITEM 032864 KET13V

Description	Technical data	Accessories	Downloads
-------------	----------------	-------------	-----------



Features

- › Front panel installation according to IEC 947-5-1 D22
- › 1 to 8 actuating directions, 4 switching elements. Stayput switch, spring return switch or combined
- › One changeover contact with tab connector 2.8 x 0.5 IEC 760 for each actuating direction
- › Center position switch

Approvals



Mechanical values and environment

Material	
	Housing thermoplastic
	Switching lever stainless steel

	Bellows elastomer black [1]
Weight	
	Net 0,1 kg
Ambient temperature	-25 ... 65 °C
Degree of protection	IP65 on the front with bellows
Mechanical life	1 x 10 ⁶
Contact material	Silver alloy
Switching principle	changeover contact C IEC 947-5-1 [2]
Mounting method	IEC 947-5-1 D22 [3]
Number of monitoring contacts	2 [4]
Connection	Tab connector 2.8x0.5 IEC760
Actuating directions	2 [5]
Interlocking	In neutral position

Electrical connection ratings

Utilization category according to EN 60947-5-1	
	AC-15 230V 4A
	DC-13 24V 2A
Short circuit protection according to IEC 60269-1	T10 / F20
Rated insulation voltage U _i	250 V
Rated impulse withstand voltage U _{imp}	2,5 kV
Switching voltage	min.10 V
Switching current	
	(at 24V) min.12 mA

[1] PAK arm

[2] Snap-action contact element, design ES587

[3] (Bore 22.5)

[4] 2 directions

[5] Button

Dimension drawing

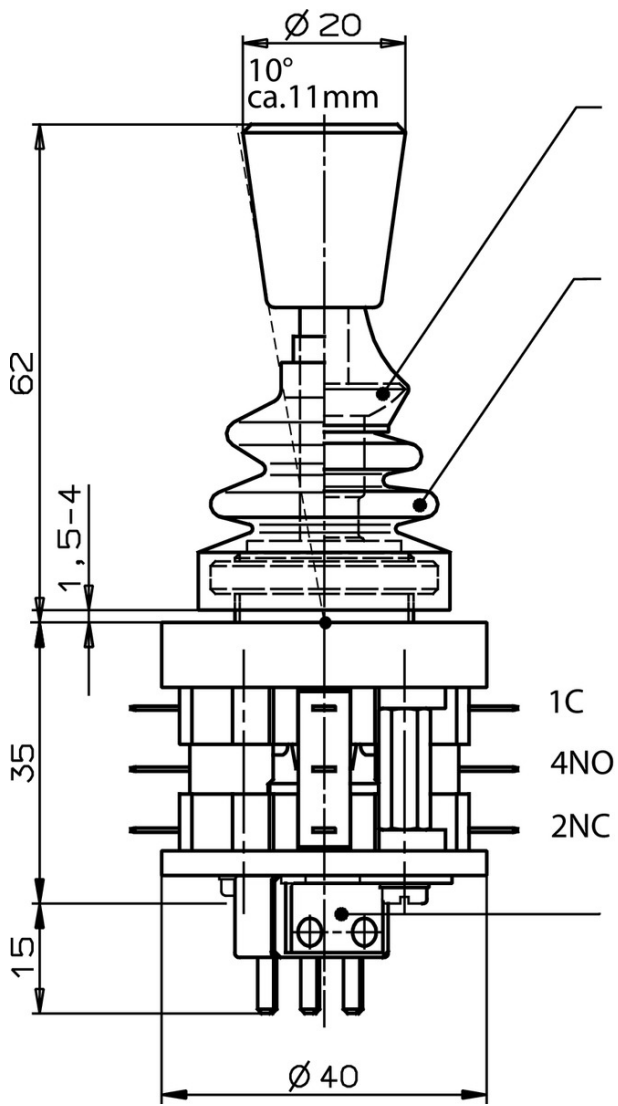

Dimension drawing

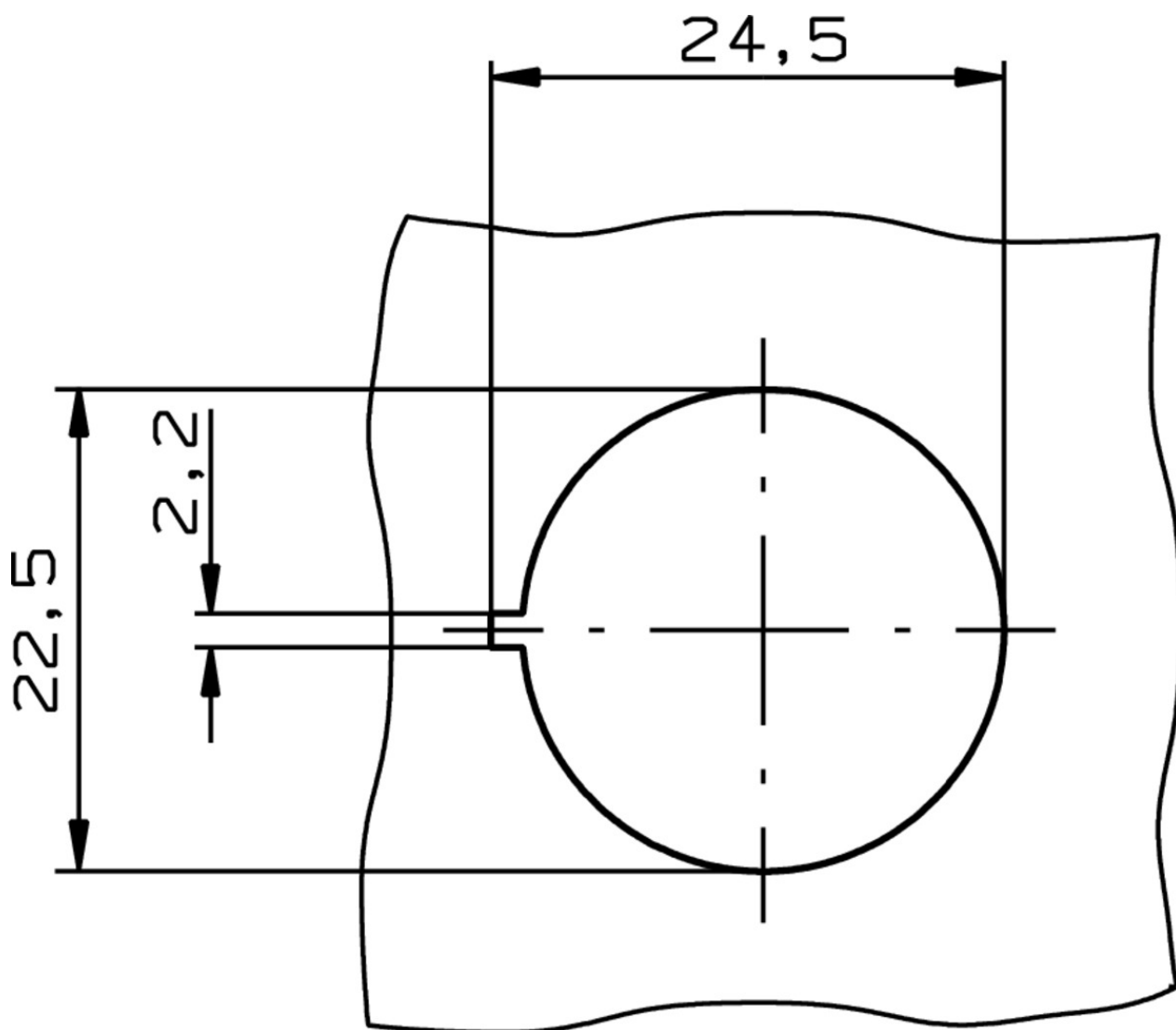

Wiring diagram

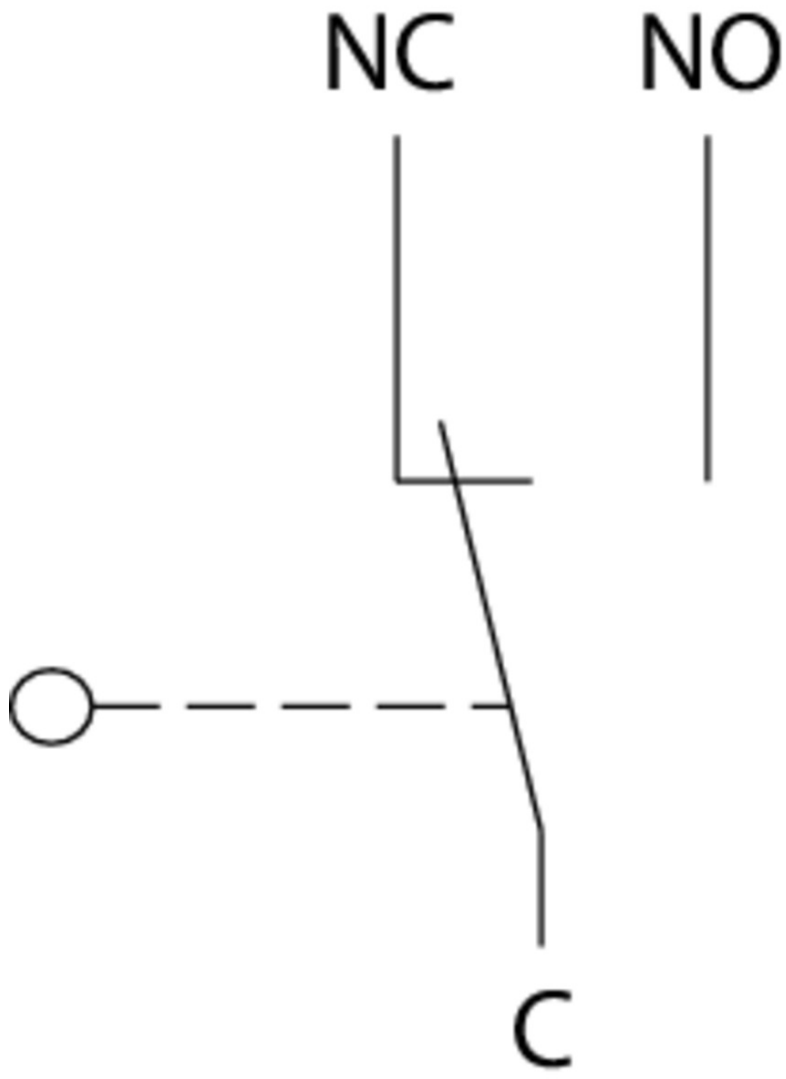

Switching functions

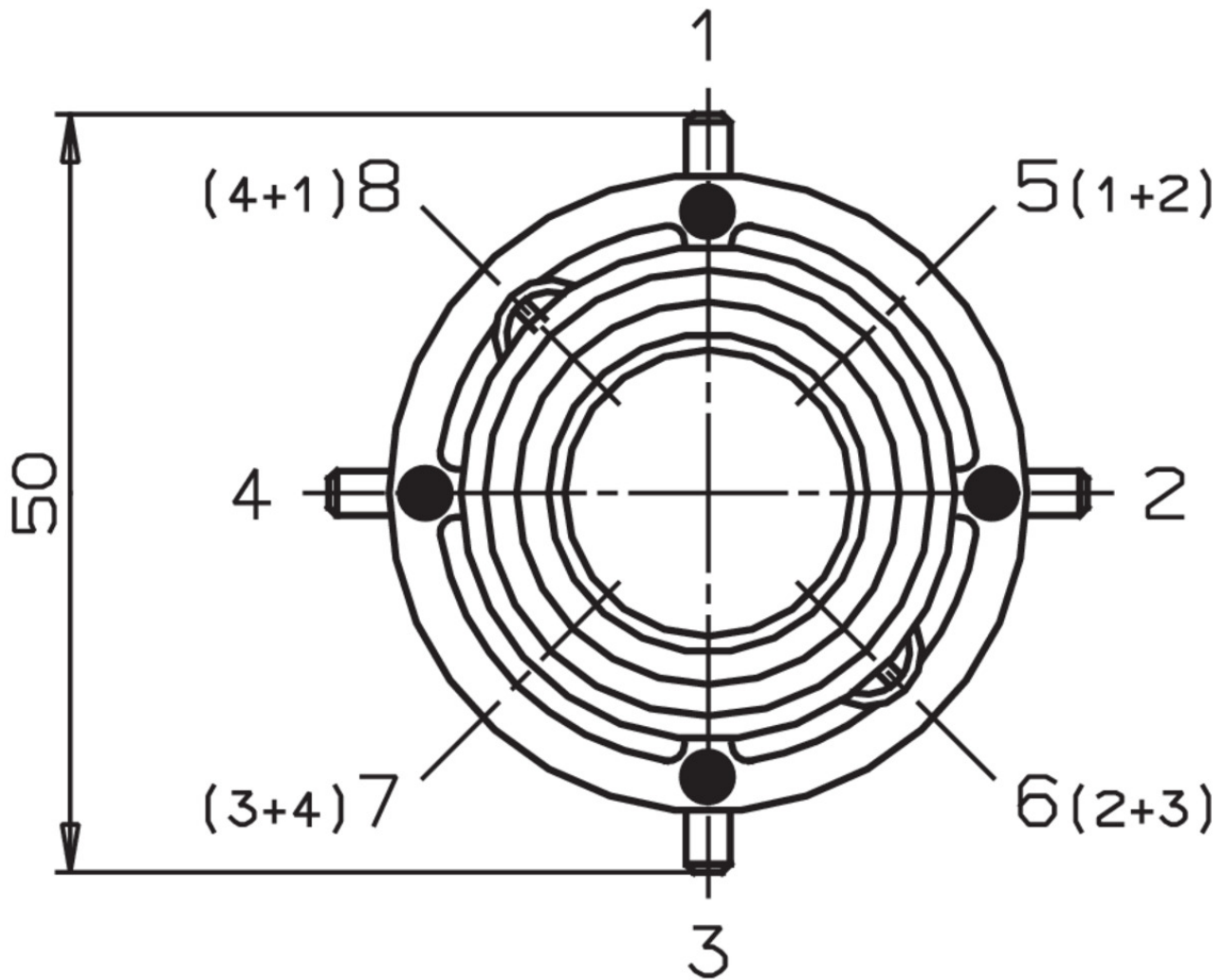

Catalogs







Einhebel-Befehlsgeräte Joystick Switches Manipulateurs Manipuladores

	Doc. no.	Version	Language	Download
Einhebel-Befehlsgeräte	076614	13-06/16		1.2 MB
Manipulateurs	111527	13-06/16		1.2 MB
Manipuladores	111528	13-06/16		1.2 MB
Joystick Switches	076654	13-06/16		1.2 MB

Declaration of conformity

EU-Konformitätserklärung

Doc. no. Version Language Download

EU-Konformitätserklärung	2108566	05-03/17		 0.2 MB
Declaración UE de conformidad				
Déclaration UE de conformité				
Dichiarazione di conformità				
EU declaration of conformity				

CAD data

CAD data for this item on TraceParts