

ITEM 071900 CIT3APL1N30-STA

Description	Technical data	Accessories	Downloads
-------------	----------------	-------------	-----------



Attention:

On the usage of a screened cable the connection cable is allowed to be max. 50 m long.

Approvals



Mechanical values and environment

Housing material	CuZn, nickel-plated
Ambient temperature	0 ... 50 °C
Degree of protection	IP67
Mounting method	Surface
Connection	M12 plug, 8-pin, axial connection ^[1]

Electrical connection ratings

Operating voltage DC	20 ... 28 V DC [2]
Current consumption	110 ... 150 mA
Switching current	-30 ... +30 mA
Type of output	Push-Pull
Resistance	Input resistance 4,5 kΩ
Output voltage	
	For HIGH levelmin.Ub - 3 V DC
	For LOW levelmax.2 V DC
Input voltage	
	SKIP input HIGH levelmin.15 V DC
	SKIP input LOW levelmax.2 V DC

Interface, bus

Data interface	4 bit binary coded + strobe
----------------	-----------------------------

in combination withData carrier **CIS3AP50X50SH16YSNOU, CIS3AP50X50SH16YSNOP**

Mechanical values and environment

Approach speed At 25°C, read distance s=12mm, center offset m=0mm for 4 hexadecimal digits	max.12 m/min [3]
---	------------------

Operating distance

Read distance At 25°C, center offset m=0mm	7 ... 12 ... 20 mm [4]
---	------------------------

in combination withData carrier **CIS3P16D08KH16YSNOU, CIS3P16D08KH16YSNOP**

Operating distance

Center offset At 25°C, read distance s=12mm	-11 ... 11 mm
--	---------------

[1] The screen on the connection cable is connected to the read head's housing via the knurled nut on the M12 plug connector.

[2] All the electrical connections must either be isolated from the mains supply by a safety transformer according to IEC/EN 61558-2-6 with limited output voltage in the event of a fault, or by other equivalent isolation measures.

[3] Reduction for each additional hexadecimal digit (at sL = 12 mm and mL = 0 mm) 1.5 m/min

[4] It is necessary to maintain the minimum distance on the approach of the data carrier from the side if the data must be transferred correctly to the read head in one transmission.

Dimension drawing

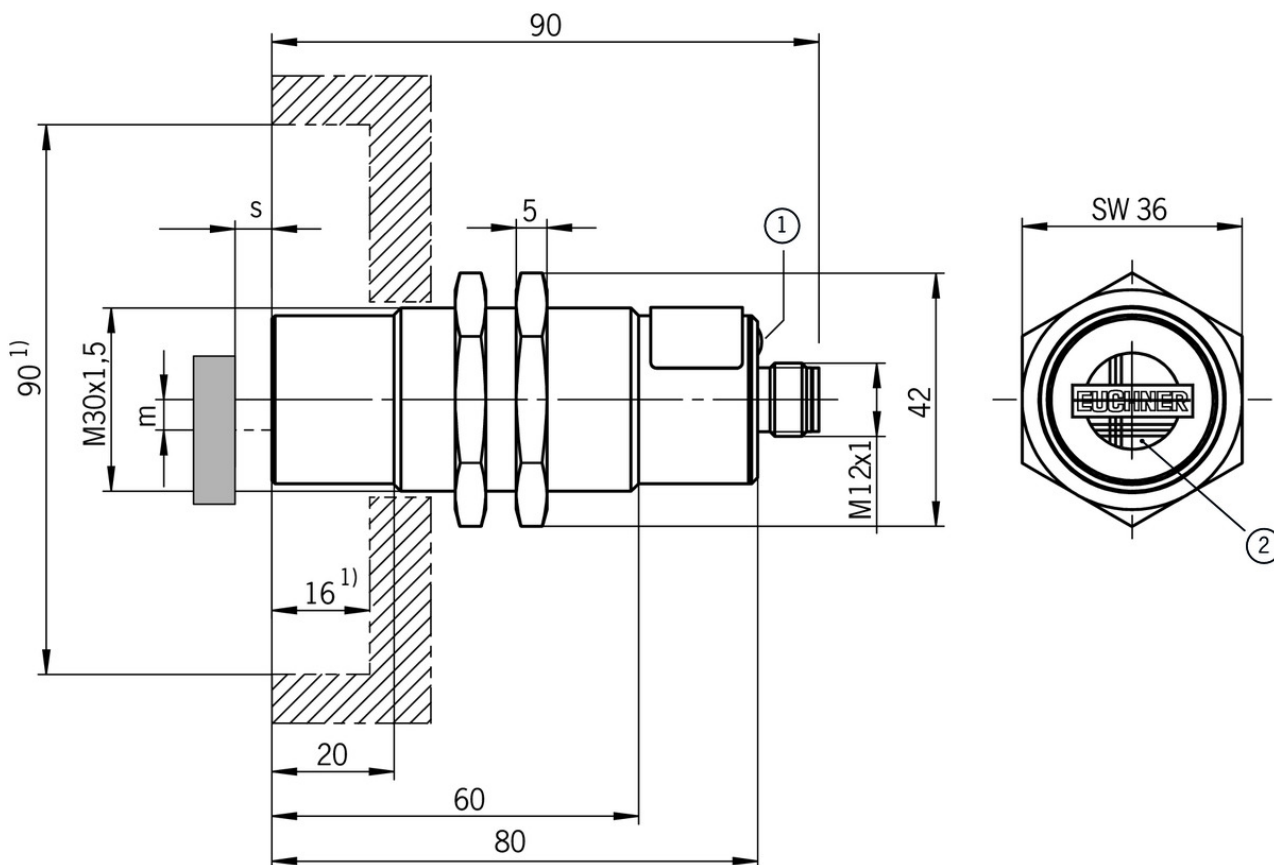

Legende

- s* Read distance
- m* Center offset
- 1) Clear zone
- 1 LED
- 2 Active face

Terminal assignment

Pin	Bezeichnung	Beschreibung	Aderfarbe
1	0V/GND	Masse, DC 0 V	WH
2	24 V/U _B	Spannungsversorgung, DC 24 V	BN
3	A	Ausgang Datenleitung A	GN
4	B	Ausgang Datenleitung B	YE
5	C	Ausgang Datenleitung C	GY
6	D	Ausgang Datenleitung D	PK
7	SKIP	Eingang Datentakt	BU
8	STROBE	Ausgang Datenträger aktiv	RD
-		Schirm	offen

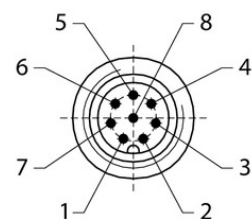

Ansicht auf Steckseite des Lesekopfs

Der Schirm der Anschlussleitung ist über die Rändelmutter des M12-Steckverbinders mit dem Gehäuse des Lesekopfs verbunden.

Connection material

-
- ▼ Connection cable with plug connector M12, 8-pin, 20m



077871 C-M12F08-08X025PV20,0-MW-077871

▼ Features

- › M12 female plug, 8-pin
 - › Straight plug connector
 - › PVC cable
 - › Cable length 20 m
 - › With flying lead
-

- ▼ Connection cable with plug connector M12, 8-pin, 5m



077751 C-M12F08-08X025PV05,0-GA-077751

▼ Features

- › M12 female plug, 8-pin
 - › Straight plug connector
 - › PVC cable
 - › Cable length 5 m
 - › With flying lead
-

- ▼ Connection cable with plug connector M12, 8-pin, 25m



077872 C-M12F08-08X025PV25,0-MW-077872

▼ Features

- › M12 female plug, 8-pin
 - › Straight plug connector
 - › PVC cable
 - › Cable length 25 m
 - › With flying lead
-

- ▼ Connection cable with plug connector M12, 8-pin, 50m



077873 C-M12F08-08X025PV50,0-MW-077873

▼ Features

- › M12 female plug, 8-pin
 - › Straight plug connector
 - › PVC cable
 - › Cable length 50 m
 - › With flying lead
-

- ▼ Connection cable with plug connector M12, 8-pin, 10m



077752 C-M12F08-08X025PV10,0-MW-077752

▼ Features

- › M12 female plug, 8-pin
 - › Straight plug connector
 - › PVC cable
 - › Cable length 10 m
 - › With flying lead
-

- ▼ Connection cable with plug connector M12, 8-pin, 15m



077753 C-M12F08-08X025PV15,0-MW-077753

▼ Features

- › M12 female plug, 8-pin
- › Straight plug connector
- › PVC cable
- › Cable length 15 m
- › With flying lead

Data carrier

▼ Data carrier CIS3A



088822 CIS3AP50X50SH16YSNOU

▼ Features

- › Square design 50 x 50 mm
- › Unprogrammed or programmed



088823 CIS3AP50X50SH16YSNOP

▼ Features

- › Square design 50 x 50 mm
- › Unprogrammed or programmed

Instructions

▼ Handbuch Induktives Schreib-Lese Identsystem CIS3(A)

	Doc. no.	Version	Language	Download
Handbuch Induktives Schreib-Lese Identsystem CIS3(A)	071652	01-08/99		0.5 MB
System - Manual Inductive Read/Write Identsystem CIS3	071652	01-08/99		0.4 MB

Catalogs











▼ Identsystem CIS Identification System CIS Système d'identification CIS

	Doc. no.	Version	Language	Download
Identsystem CIS	076621	03-01/13		5.6 MB
Système d'identification CIS	110763	03-01/13		5.5 MB
Identification System CIS	076660	03-01/13		5.5 MB

Declaration of conformity

▼ EC-Declaration of Conformity CIT3; CIA3; CIS3

Doc. no.	Version	Language	Download
----------	---------	----------	----------

EG-Konformitätserklärung CIT3; CIA3; CIS3	077155	10-01/17		 0.3 MB
EC-Declaration of Conformity CIT3; CIA3; CIS3				
CE-Declaración de Conformidad CIT3; CIA3; CIS3				
CE-Déclaration de Conformité CIT3; CIA3; CIS3				
CE-Dichiarazione di conformità CIT3; CIA3; CIS3				
EU-Konformitätserklärung	077155	10-01/17		 0.3 MB
Declaración UE de conformidad				
Déclaration UE de conformité				
Dichiarazione di conformità				
EU declaration of conformity			