

ITEM 077940 CIT3ASX1N12ST

Description	Technical data	Accessories	Downloads
-------------	----------------	-------------	-----------



Features

- › Use with interface adapter CIA3...
- › Cylindrical design M12
- › M8 plug connector
- › Axial connection

Notice

The read head CIT3ASX1N12ST has

- › Read-only functionality in combination with the read-only interface adapter with parallel interface
- › Read/write functionality in combination with the read/write interface adapter with serial interface

Attention:

On the usage of a screened cable the connection cable to the interface adapter is allowed to be max. 15 m long.

Mechanical values and environment

Housing material	
Housing sleeve	CuZn nickel-plated
Ambient temperature	0 ... 50 °C
Degree of protection	IP65
Mounting method	Surface
Tightening torque	5 ... 9 Nm
Connection	M8 plug connector, 4-pin, axial connection

Electrical connection ratings

LED indicator	Yellow: Data carrier active
---------------	-----------------------------

Dimension drawing

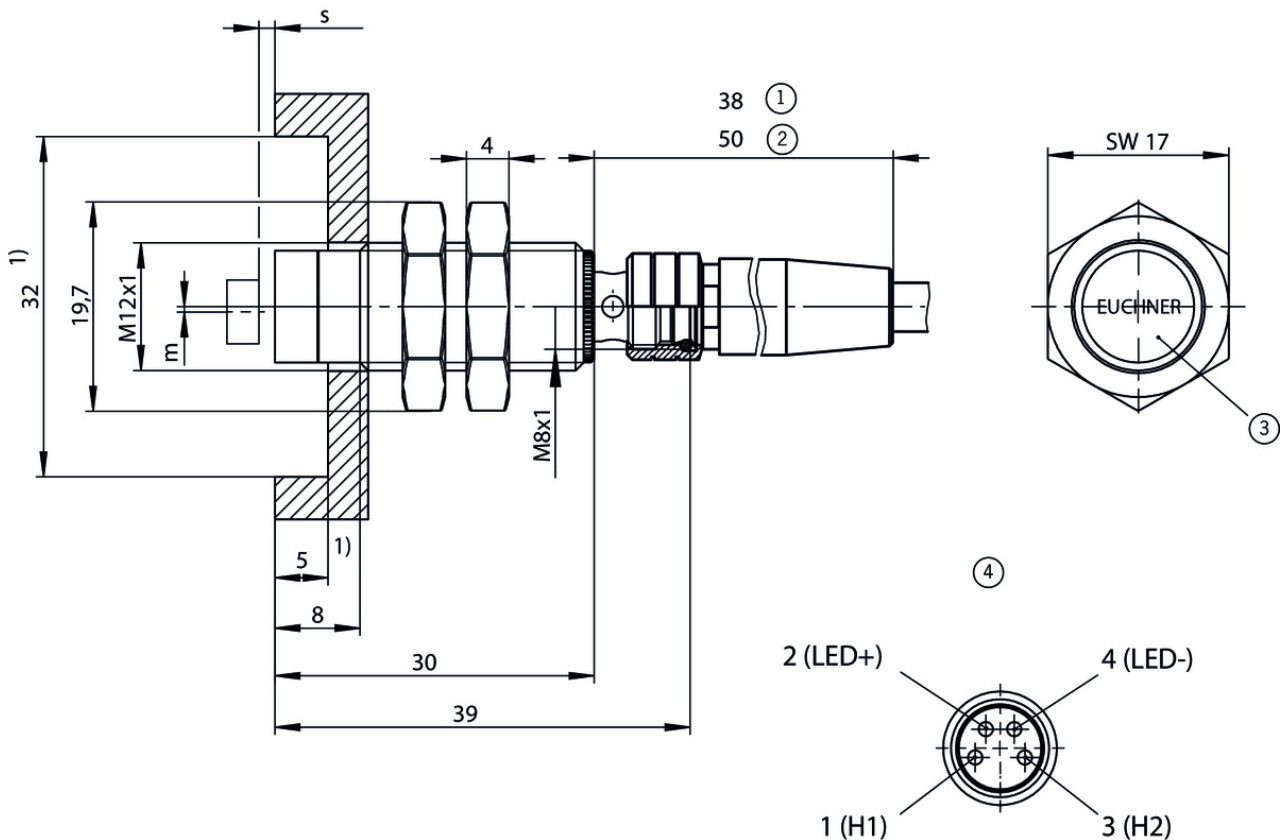

Legende

- s* Read distance
- m* Center offset
- 1) Clear zone
- 1 Inserted
- 2 To insert
- 3 Active face
- 4 Terminal assignment

Terminal assignment

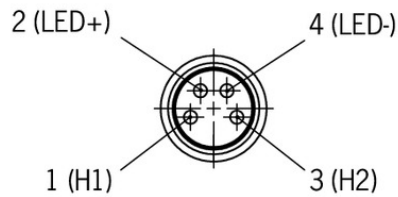

Der Schirm der Anschlussleitung ist über die Rändelmutter des M8-Steckverbinders mit dem Gehäuse des Schreib-/Lesekopfs verbunden.

Ansicht auf Steckseite des Lesekopfs

Pin	Bezeichnung	Beschreibung	Aderfarbe
1	H1	Antenne H1	BN
2	LED +	LED-Anschluss +	YE
3	H2	Antenne H2	WH
4	LED -	LED-Anschluss -	GN
-		Schirm	BK

Data carrier

▼ Data carrier CIS3A-Mini



092320 CIS3AP10D05KH01K-P

▼ Features

- › Cylindrical design Ø 10 mm
- › Programmed



077785 CIS3AP10D05KH01K

▼ Features

- › Cylindrical design Ø 10 mm
- › Unprogrammed

Connection material

▼ Connection cable with plug connector M8, 4-pin, 10m



084643 C-M08F04-04X025PV10,0-ES-084643

▼ Features

- › M8 female plug, 4-pin
- › Straight plug connector
- › PVC cable
- › Cable length 10 m
- › With flying lead
- › Knurled nut electrically connected to cable screen

▼ Connection cable with plug connector M8, 4-pin, 2m

084641 C-M08F04-04X025PV02,0-ES-084641



- ▼ Features
 - › M8 female plug, 4-pin
 - › Straight plug connector
 - › PVC cable
 - › Cable length 2 m
 - › With flying lead
 - › Knurled nut electrically connected to cable screen

▼ Connection cable with plug connector M8, 4-pin, 5m



084642 C-M08F04-04X025PV05,0-ES-084642

- ▼ Features
 - › M8 female plug, 4-pin
 - › Straight plug connector
 - › PVC cable
 - › Cable length 5 m
 - › With flying lead
 - › Knurled nut electrically connected to cable screen

▼ Connection cable with plug connector M8, 4-pin, 15m



084644 C-M08F04-04X025PV15,0-ES-084644

- ▼ Features
 - › M8 female plug, 4-pin
 - › Straight plug connector
 - › PVC cable
 - › Cable length 15 m
 - › With flying lead
 - › Knurled nut electrically connected to cable screen

Instructions

▼ Handbuch Induktives Schreib-/Lesesystem CIS3A-Mini

	Doc. no.	Version	Language	Download
Handbuch Induktives Schreib-/Lesesystem CIS3A-Mini	084727	01-02/03		0.3 MB
System - Manual Inductive Read/Write Identysystem CIS3A-Mini	084727	01-02/03		0.3 MB











Catalogs

▼ Identysystem CIS Identification System CIS Système d'identification CIS

	Doc. no.	Version	Language	Download
Identysystem CIS	076621	03-01/13		5.6 MB
Système d'identification CIS	110763	03-01/13		5.5 MB
Identification System CIS	076660	03-01/13		5.5 MB

Declaration of conformity

 EC-Declaration of Conformity CIT3; CIA3; CIS3

	Doc. no.	Version	Language	Download
EG-Konformitätserklärung CIT3; CIA3; CIS3	077155	10-01/17		 0.3 MB
EC-Declaration of Conformity CIT3; CIA3; CIS3				
CE-Declaración de Conformidad CIT3; CIA3; CIS3				
CE-Déclaration de Conformité CIT3; CIA3; CIS3				
CE-Dichiarazione di conformità CIT3; CIA3; CIS3				
EU-Konformitätserklärung	077155	10-01/17		 0.3 MB
Declaración UE de conformidad				
Déclaration UE de conformité				
Dichiarazione di conformità				
EU declaration of conformity			