

ITEM 084750 EKS-A-ISX-G01-ST09/03

Description	Technical data	Accessories	Downloads
-------------	----------------	-------------	-----------

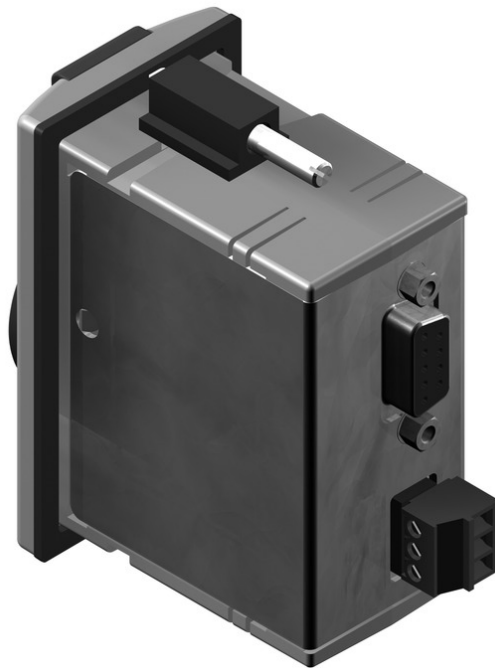

Features

- › Electronic-Key Adapter with serial interface RS232/RS422
- › read/write system
- › Electronic-Key adapter and electronics in one housing
- › Reliable retention of the Electronic-Key, even if there is heavy vibration
- › Transfers the data from the Electronic-Key to a control system for processing
- › Connection to PC or PLC
- › Open communication commands at the lowest level
- › 3964R protocol
- › Interfacing to the user software via ActiveX[®] module in Windows[®] possible

Approvals



Mechanical values and environment

Housing material	PA6-GF30 gray
Ambient temperature	0 ... 55 °C
Degree of protection	IP67 in the installed state (only access side)
Mounting cut-out according to DIN 43700	33 x 68 mm
Installation position	On the front
	Interface, data transfer
Connection	D-Sub 9-pin RS232/RS422 can be selected via DIP switches
Cable length	
	RS232max.5 m
	RS422max.1000 m

Electrical connection ratings

LED indicator	Green	Operational
	Yellow	Key in operating distance
		Power supply
Operating voltage DC		20 ... 24 ... 28 V DC
Current consumption		max.100 mA
Output current		Output OUT at 24Vmax.30 mA

Interface, bus

	Interface, data transfer
Data protocol	3964R via RS232/RS422
Data rate	9600 ... 28800 kbit/s

Dimension drawing

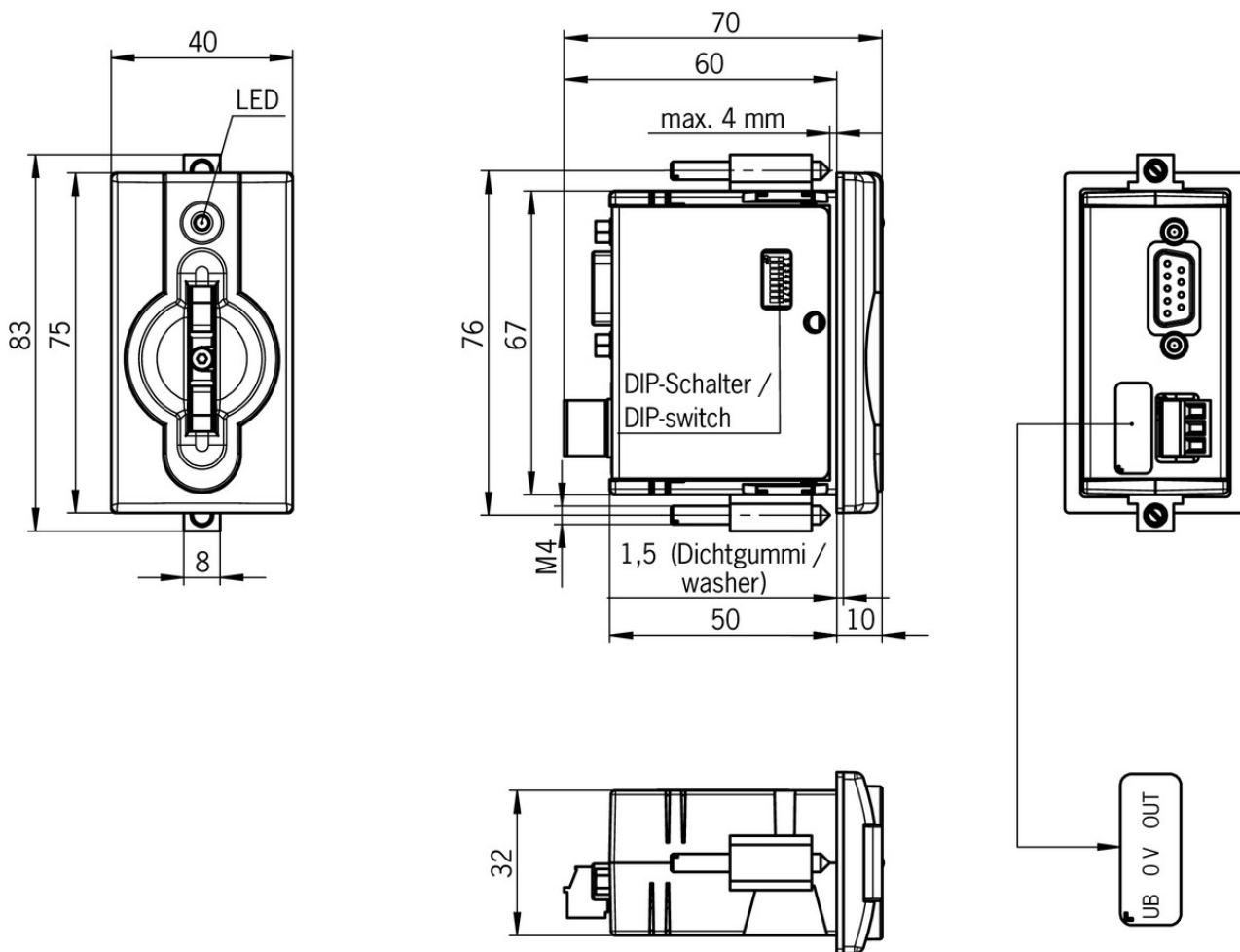

Block diagram

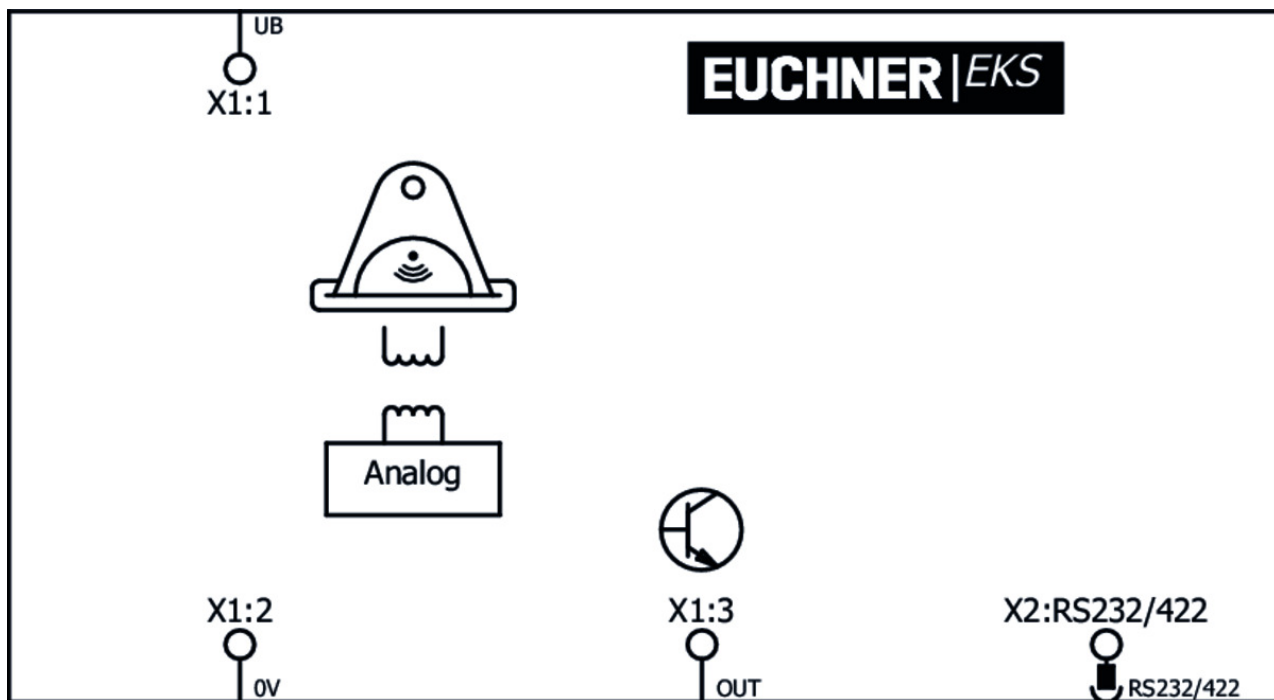

Electronic-Key

✔ Electronic-Key read/write



091045 EKS-A-K1BUWT32-EU

✔ Features

- › Memory 116 bytes E²PROM (programmable) plus 8 bytes ROM (serial number)



094839 EKS-A-K1GNWT32-EU

✔ Features

- › Memory 116 bytes E²PROM (programmable) plus 8 bytes ROM (serial number)



094840 EKS-A-K1YEWT32-EU

✔ Features

- › Memory 116 bytes E²PROM (programmable) plus 8 bytes ROM (serial number)



084735 EKS-A-K1BKWT32-EU

✔ Features

- › Memory 116 bytes E²PROM (programmable) plus 8 bytes ROM (serial number)



077859 EKS-A-K1RDWT32-EU

✔ Features

- › Memory 116 bytes E²PROM (programmable) plus 8 bytes ROM (serial number)



123097 EKS-A-K1WHWT32-EU

✔ Features

- › Memory 116 bytes E²PROM (programmable) plus 8 bytes ROM (serial number)



123098 EKS-A-K1OGWT32-EU

✔ Features

- › Memory 116 bytes E²PROM (programmable) plus 8 bytes ROM (serial number)

Software

✔ Transponder Coding (TC)



067190 ANWPG TRANSPONDER CODING VERKAUF

✔ Features

- › Software for reading and writing CIS data carriers or EKS Electronic-Keys

▼ Electronic Key Manager EKM demo version



093320 ANWPG ELECTRONIC KEY MANAGER DEMO

▼ Features

- › Software for key management
 - › Only local EKM client, no network support
 - › Access to key database and key database export/import in csv format
 - › Limited to 10 weeks runtime
-

▼ Electronic Key Manager EKM single-user version



098578 ANWPG ELECTRONIC KEY MANAGER EINZEL

▼ Features

- › Software for key management
 - › Only local EKM client, no network support
 - › Access to key database and key database export/import in csv format
 - › Forms and databases prepared using the demo version or light version can continue to be used with the full version
 - › Includes additional documentation EKM (CRC definition) - order no. 093653 on CD
-

▼ Electronic Key Manager EKM full version



093322 ANWPG ELECTRONIC KEY MANAGER

▼ Features

- › Software for key management
 - › Client/server architecture, full network support
 - › Access to key database and key database export/import in csv format
 - › Forms and databases prepared using the demo version, light version or single-user version can continue to be used with the full version
 - › Includes EKM ActiveX[®] module for interfacing the EKM database to any user program with ActiveX[®] support (e.g. for visualization)
 - › Includes EKM ActiveX[®] module manual - order no. 093650 on CD
 - › Includes additional documentation EKM (CRC definition) - order no. 093653 on CD
-

▼ ActiveX[®] module - serial communication



098708 ANWPG EKS ACTIVEX-MODULE CD-ROM

▼ Features

- › Protocol driver software for integrating the EKS Electronic-Key adapters with serial or USB interface into a PC application in Windows
-

▼ Electronic Key Manager EKM Light version







111410 ANWPG ELECTRONIC KEY MANAGER LIGHT

▼ Features

- › Software for setting key parameters
 - › Only local EKM client, no network support
 - › No access to key database and no key database export/import
-



Instructions

Handbuch EKS Schlüsselaufnahme seriell

	Doc. no.	Version	Language	Download
Handbuch EKS Schlüsselaufnahme seriell	088796	02-03/05		 0.3 MB
Manual EKS Electronic-Key Adapter serial	088796	02-03/05		 0.3 MB



Catalogs

Electronic-Key-System EKS Electronic-Key-System EKS Electronic-Key-System EKS Electronic-Key-System EKS





	Doc. no.	Version	Language	Download
Electronic-Key-System EKS	086808	14-04/17		 3.2 MB
Electronic-Key-System EKS	092953	14-04/17		 3.2 MB
Electronic-Key-System EKS	114432	14-04/17		 3.2 MB
Electronic-Key-System EKS	086809	14-04/17		 3.2 MB

Application example



Connection of EKS-084750 to FANUC CNC

	Doc. no.	Version	Language	Download
Connection of EKS-084750 to FANUC CNC	AP000233	01-02/18		 0.2 MB



Definition der Schlüsselstruktur auf einem EKS-Schlüssel

	Doc. no.	Version	Language	Download
Definition der Schlüsselstruktur auf einem EKS-Schlüssel	AP000169-1	02-09/15		 0.5 MB
Definition of the Electronic-Key structure on an EKS Key	AP000169-1	02-09/15		 0.4 MB





EKS mit Datenschnittstelle: Weitergabe von Informationen an Maschinenbauer

	Doc. no.	Version	Language	Download
EKS mit Datenschnittstelle: Weitergabe von Informationen an Maschinenbauer	AP000169-6	02-09/15		 0.2 MB





EUCHNER EKS FSA Research Report

	Doc. no.	Version	Language	Download
EUCHNER EKS FSA Research Report	AP000169-IFA	01-09/15		 0.3 MB

Einrichten der EKM Software als Programmierplatz







	Doc. no.	Version	Language	Download
Einrichten der EKM Software als Programmierplatz	AP000169-2	02-09/15		 1.0 MB
Setting up the EKM software as a programming station	AP000169-2	02-09/15		 0.9 MB

Übersicht über EKS-Applikationen

	Doc. no.	Version	Language	Download
Übersicht über EKS-Applikationen	AP000169	02-09/15		 0.5 MB
Overview of EKS applications	AP000169	02-09/15		 0.3 MB

Declaration of conformity

EU-Konformitätserklärung

	Doc. no.	Version	Language	Download
EU-Konformitätserklärung	2093140	07-01/17		 0.3 MB
Declaración UE de conformidad				
Déclaration UE de conformité				
Dichiarazione di conformità				
EU declaration of conformity				

CAD data

CAD data for this item on TraceParts