

## ITEM 084800 EKS-A-IDX-G01-ST09/03

Description	Technical data	Accessories	Downloads
-------------	----------------	-------------	-----------



### Features

- › Electronic-Key adapter with PROFIBUS DP interface
- › read/write system
- › Remote installation
- › Electronic-Key adapter and electronics in one housing
- › Reliable retention of the Electronic-Key, even if there is heavy vibration
- › Transfers the data from the Electronic-Key to a control system for processing
- › Connection to PLC
- › PROFIBUS protocol, cyclic data transfer to control system
- › Interfacing via GSD file
- › Address assignment via DIP switches

### Approvals



### Mechanical values and environment

Housing material	PA6-GF30 gray
Ambient temperature	0 ... 55 °C
Degree of protection	IP67 in installed state (only access side)
Mounting cut-out according to DIN 43700	33 x 68 mm
Installation position	On the front
	<b>PROFIBUS DP</b>
Connection	D-Sub 9-pin

---

### Electrical connection ratings

LED indicator		
	Green	Operational
	Yellow	Key in operating distance
	Red	Fault
		<b>Power supply</b>
Operating voltage DC		20 ... 24 ... 28 V DC
Current consumption		max.150 mA

---

### Interface, bus

	<b>PROFIBUS DP</b>
Data protocol	Profibus DP according to EN50170

---

**Dimension drawing**

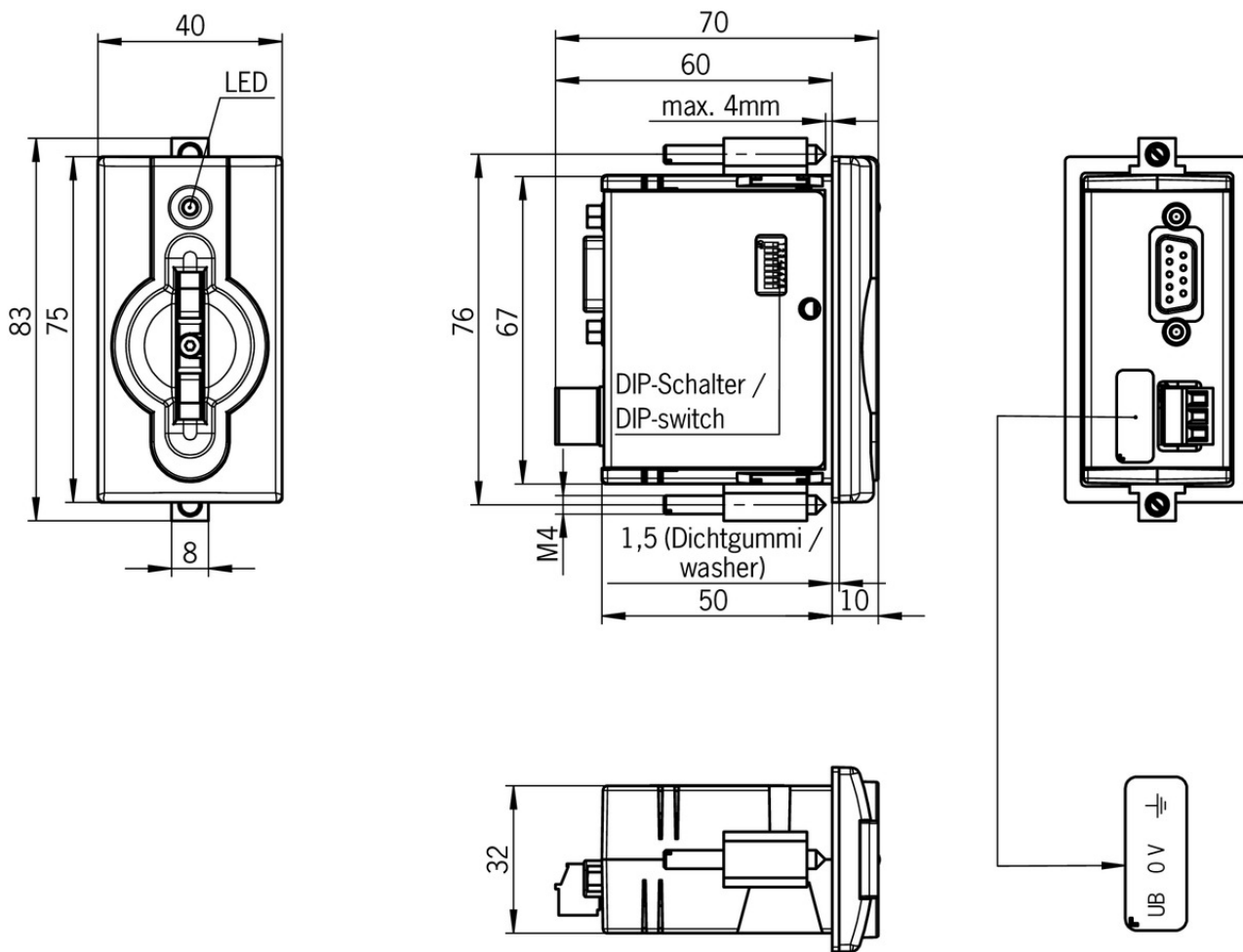

**Block diagram**

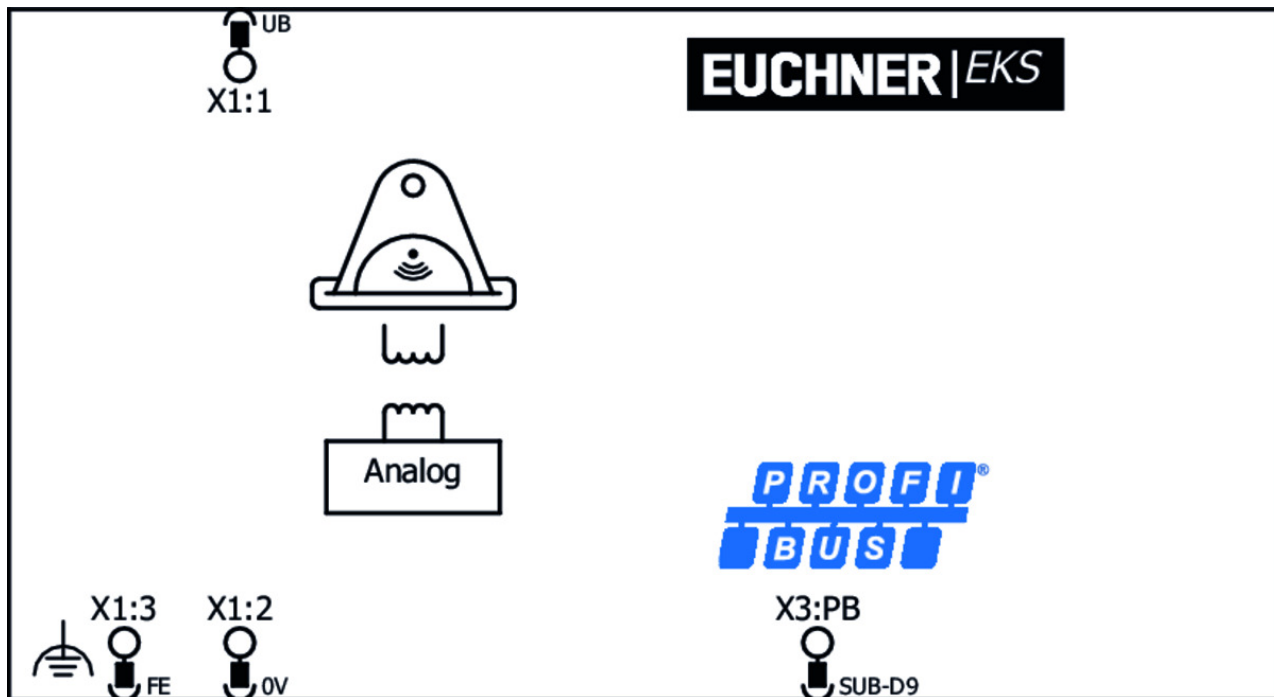

## Electronic-Key

---

### ✔ Electronic-Key read/write



**077859** EKS-A-K1RDWT32-EU

#### ✔ Features

- › Memory 116 bytes E<sup>2</sup>PROM (programmable) plus 8 bytes ROM (serial number)
- 



**084735** EKS-A-K1BKWT32-EU

#### ✔ Features

- › Memory 116 bytes E<sup>2</sup>PROM (programmable) plus 8 bytes ROM (serial number)
- 



**094839** EKS-A-K1GNWT32-EU

#### ✔ Features

- › Memory 116 bytes E<sup>2</sup>PROM (programmable) plus 8 bytes ROM (serial number)
- 



**094840** EKS-A-K1YEWT32-EU

#### ✔ Features

- › Memory 116 bytes E<sup>2</sup>PROM (programmable) plus 8 bytes ROM (serial number)
- 



**091045** EKS-A-K1BUWT32-EU

#### ✔ Features

- › Memory 116 bytes E<sup>2</sup>PROM (programmable) plus 8 bytes ROM (serial number)
- 



**123097** EKS-A-K1WHWT32-EU

#### ✔ Features

- › Memory 116 bytes E<sup>2</sup>PROM (programmable) plus 8 bytes ROM (serial number)
- 



**123098** EKS-A-K1OGWT32-EU

#### ✔ Features

- › Memory 116 bytes E<sup>2</sup>PROM (programmable) plus 8 bytes ROM (serial number)
- 

## Instructions







### ✔ Manual EKS Electronic-Key Adapter PROFIBUS-DP & PROFIBUS-DP FSA

**Doc. no.**   **Version**   **Language**   **Download**

Handbuch EKS Schlüsselaufnahme PROFIBUS-DP & PROFIBUS-DP FSA	092009	03-10/07		 1.4 MB
Manual EKS Electronic-Key Adapter PROFIBUS-DP & PROFIBUS-DP FSA	092009	03-10/07		 0.9 MB





## Catalogs

### ▼ Electronic-Key-System EKS Electronic-Key-System EKS Electronic-Key-System EKS Electronic-Key-System EKS



	Doc. no.	Version	Language	Download
Electronic-Key-System EKS	086808	14-04/17		 3.2 MB
Electronic-Key-System EKS	092953	14-04/17		 3.2 MB
Electronic-Key-System EKS	114432	14-04/17		 3.2 MB
Electronic-Key-System EKS	086809	14-04/17		 3.2 MB

## Application example



### ▼ Definition der Schlüsselstruktur auf einem EKS-Schlüssel

	Doc. no.	Version	Language	Download
Definition der Schlüsselstruktur auf einem EKS-Schlüssel	AP000169-1	02-09/15		 0.5 MB
Definition of the Electronic-Key structure on an EKS Key	AP000169-1	02-09/15		 0.4 MB



### ▼ EKS an Siemens S7-300 – CRC prüfen

	Doc. no.	Version	Language	Download
EKS an Siemens S7-300 – CRC prüfen	AP000169-5	02-09/15		 0.5 MB
EKS on Siemens S7-300 – checking CRC	AP000169-5	02-09/15		 0.3 MB



### ▼ EKS mit Datenschnittstelle: Weitergabe von Informationen an Maschinenbauer

	Doc. no.	Version	Language	Download
EKS mit Datenschnittstelle: Weitergabe von Informationen an Maschinenbauer	AP000169-6	02-09/15		 0.2 MB



### ▼ EKS-Profibus an Siemens S7-300 – EKS Schlüssel einlesen



	Doc. no.	Version	Language	Download
EKS-Profibus an Siemens S7-300 – EKS Schlüssel einlesen	AP000169-3	03-04/16		 0.6 MB
EKS Profibus on Siemens S7-300 – reading in EKS Electronic-Keys	AP000169-3	03-04/16		 0.3 MB

### ▼ EUCHNER EKS FSA Research Report



	Doc. no.	Version	Language	Download
EUCHNER EKS FSA Research Report	AP000169-IFA	01-09/15		 0.3 MB

### ▼ Einrichten der EKM Software als Programmierplatz

	Doc. no.	Version	Language	Download
Einrichten der EKM Software als Programmierplatz	AP000169-2	02-09/15		 1.0 MB







Setting up the EKM software as a programming station AP000169-2 02-09/15   0.9 MB

 Übersicht über EKS-Applikationen

	Doc. no.	Version	Language	Download
Übersicht über EKS-Applikationen	AP000169	02-09/15		 0.5 MB
Overview of EKS applications	AP000169	02-09/15		 0.3 MB

### Declaration of conformity

 EU-Konformitätserklärung

	Doc. no.	Version	Language	Download
EU-Konformitätserklärung	2093140	07-01/17		 0.3 MB
Declaración UE de conformidad				
Déclaration UE de conformité				
Dichiarazione di conformità				
EU declaration of conformity				

### CAD data

CAD data for this item on TraceParts