

ITEM 092750 EKS-A-IUX-G01-ST01

Description	Technical data	Accessories	Downloads
-------------	----------------	-------------	-----------

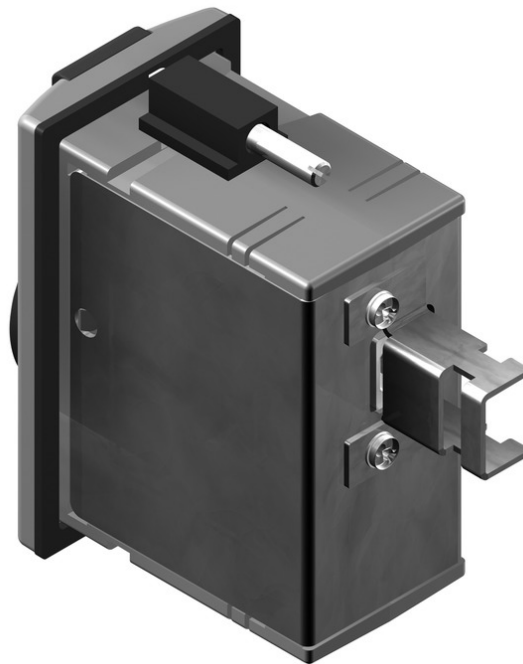

Features

- › Electronic-Key adapter with USB interface
- › read/write system
- › Power supply via USB interface
- › Electronic-Key adapter and electronics in one housing
- › Reliable retention of the Electronic-Key, even if there is heavy vibration
- › Transfers the data from the Electronic-Key to a control system for processing
- › Connection to PC
- › Virtual serial COM port
- › Especially recommended for setting up a programming station on a PC
- › Open communication commands at the lowest level
- › 3964R protocol
- › Interfacing to the user software via ActiveX[®] module in Windows[®] possible

Approvals



Mechanical values and environment

Housing material	PA6-GF30 gray
Ambient temperature	0 ... 55 °C
Degree of protection	IP67 in installed state (only access side)
Mounting cut-out according to DIN 43700	33 x 68 mm
Installation position	On the front
	USB interface
Connection	USB full speed type B
Cable length	USBmax.3 m

Electrical connection ratings

Current consumption	max.100 mA
LED indicator	
	Green Operational
	Yellow Key in operating distance

Interface, bus

	USB interface
Data protocol	3964R via USB
Data rate	9600 ... 28800 kbit/s

Dimension drawing

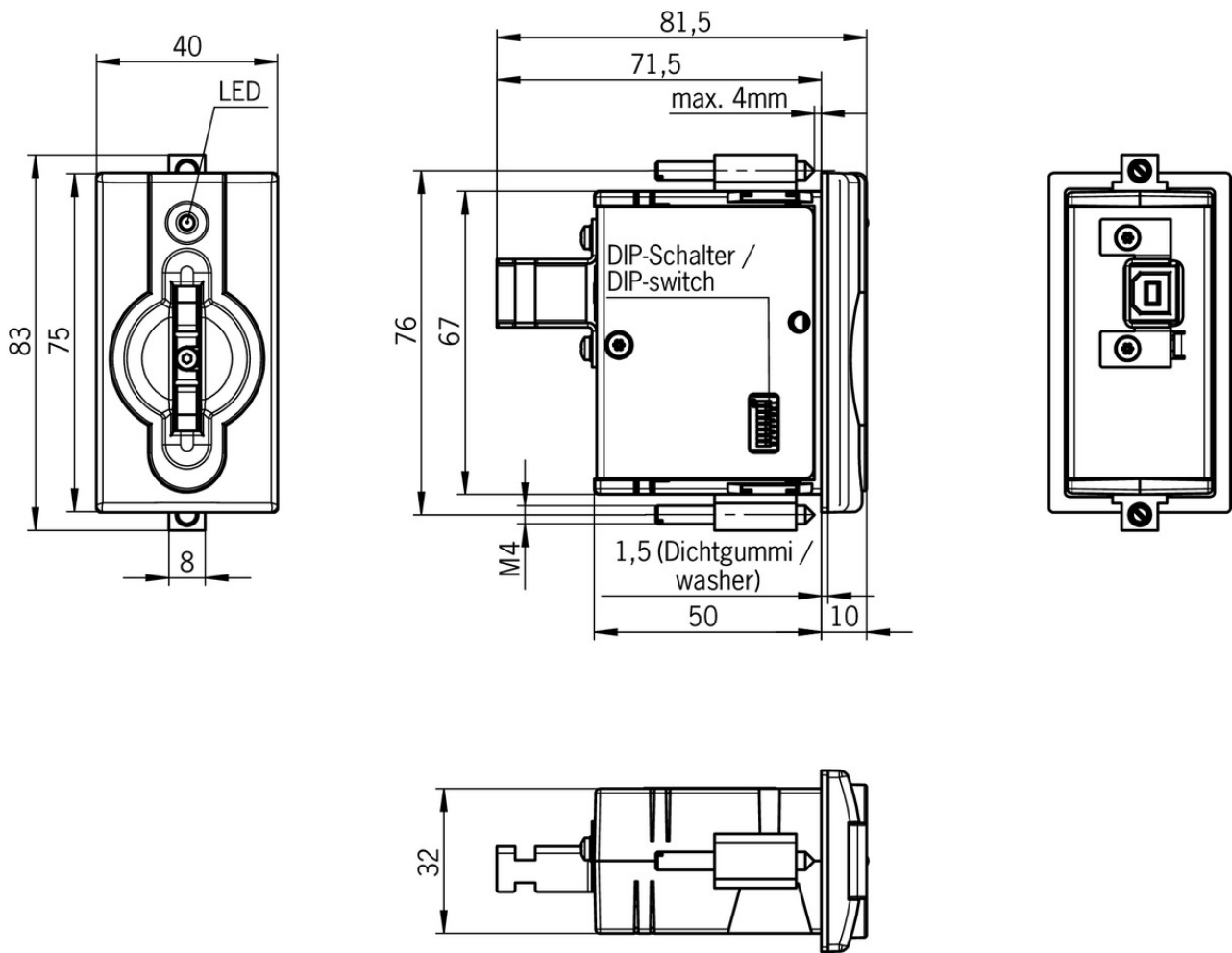

Block diagram

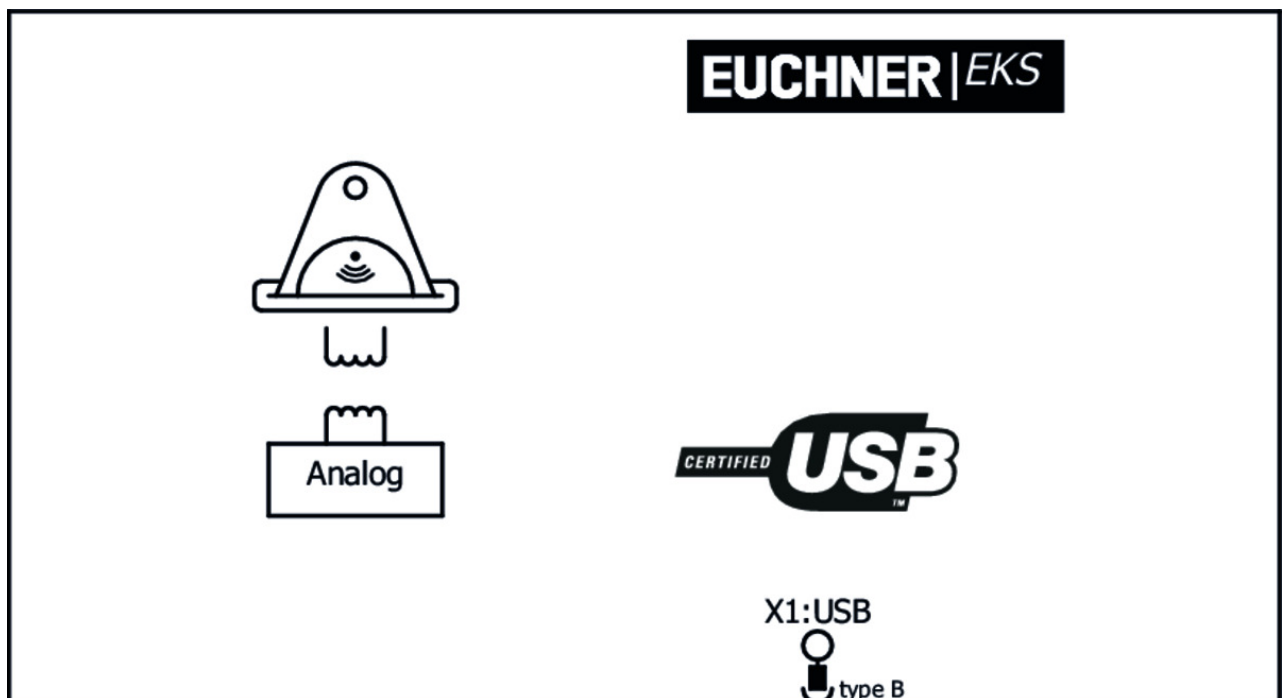

Software

▼ Electronic Key Manager EKM demo version



093320 ANWPG ELECTRONIC KEY MANAGER DEMO

▼ Features

- › Software for key management
 - › Only local EKM client, no network support
 - › Access to key database and key database export/import in csv format
 - › Limited to 10 weeks runtime
-

▼ Transponder Coding (TC)



067190 ANWPG TRANSPONDER CODING VERKAUF

▼ Features

- › Software for reading and writing CIS data carriers or EKS Electronic-Keys
-

▼ ActiveX® module - serial communication



098708 ANWPG EKS ACTIVEX-MODULE CD-ROM

▼ Features

- › Protocol driver software for integrating the EKS Electronic-Key adapters with serial or USB interface into a PC application in Windows
-

▼ Electronic Key Manager EKM single-user version



098578 ANWPG ELECTRONIC KEY MANAGER EINZEL

▼ Features

- › Software for key management
 - › Only local EKM client, no network support
 - › Access to key database and key database export/import in csv format
 - › Forms and databases prepared using the demo version or light version can continue to be used with the full version
 - › Includes additional documentation EKM (CRC definition) - order no. 093653 on CD
-

▼ Electronic Key Manager EKM full version



093322 ANWPG ELECTRONIC KEY MANAGER

▼ Features

- › Software for key management
- › Client/server architecture, full network support
- › Access to key database and key database export/import in csv format
- › Forms and databases prepared using the demo version, light version or single-user version can continue to be used with the full version
- › Includes EKM ActiveX® module for interfacing the EKM database to any user program with ActiveX® support (e.g. for visualization)
- › Includes EKM ActiveX® module manual - order no. 093650 on CD
- › Includes additional documentation EKM (CRC definition) - order no. 093653 on CD

▼ Electronic Key Manager EKM Light version



111410 ANWPG ELECTRONIC KEY MANAGER LIGHT

▼ Features

- › Software for setting key parameters
 - › Only local EKM client, no network support
 - › No access to key database and no key database export/import
-

Electronic-Key

▼ Electronic-Key read/write



094840 EKS-A-K1YEWT32-EU

▼ Features

- › Memory 116 bytes E²PROM (programmable) plus 8 bytes ROM (serial number)
-



094839 EKS-A-K1GNWT32-EU

▼ Features

- › Memory 116 bytes E²PROM (programmable) plus 8 bytes ROM (serial number)
-



084735 EKS-A-K1BKWT32-EU

▼ Features

- › Memory 116 bytes E²PROM (programmable) plus 8 bytes ROM (serial number)
-



077859 EKS-A-K1RDWT32-EU

▼ Features

- › Memory 116 bytes E²PROM (programmable) plus 8 bytes ROM (serial number)
-



091045 EKS-A-K1BUWT32-EU

▼ Features

- › Memory 116 bytes E²PROM (programmable) plus 8 bytes ROM (serial number)
-



123097 EKS-A-K1WHWT32-EU

▼ Features

- › Memory 116 bytes E²PROM (programmable) plus 8 bytes ROM (serial number)
-



123098 EKS-A-K1OGWT32-EU

▼ Features

- › Memory 116 bytes E²PROM (programmable) plus 8 bytes ROM (serial number)
-

Connection material

☑ Connection cable with USB type B to female plug, 5-pin



095633 EKS USB - PC INTERN

☑ Features

- › USB 2.0 cable type B to tab connector, 4-core
 - › Straight plug connector
 - › Cable length 0.8 m
 - › Double-screened cable
-

Miscellaneous accessories

☑ PC mounting frame



093615 EKS PC-MOUNTING FRAME

☑ Features

- › PC mounting frame for 5.25" drive bay
 - › For installing the EKS Electronic-Key adapter in a PC
 - › Front signal black matt RAL 9004
 - › Including 4 fixing screws
 - › An optional connection cable is available for the connection from the USB Electronic-Key adapter to the internal USB connection on the motherboard
-

☑ Desktop case



113106 EKS DESKTOP CASE

☑ Features

- › Establishment of a programming station for Electronic-Key management on the desk
 - › EKS data entry station on desktop for which a degree of protection is not required
 - › Installation of the compact version of the Electronic-Key adapter (all interfaces)
 - › Easy mounting from above in removable cover (2-piece housing, bottom open)
 - › Strain relief for connection cable
 - › Including mounting parts (note: screw clamp elements are included with the Electronic-Key adapter)
 - › ATTENTION: Figure shows desktop case including key adapter. Electronic-Key adapter not included.
-

Instructions







☑ Handbuch EKS Schlüsselaufnahme USB & USB FSA

Doc. no. **Version** **Language** **Download**

Handbuch EKS Schlüsselaufnahme USB & USB FSA	094485	04-11/13		 2.6 MB
Manual EKS Electronic-Key adapter USB & USB FSA	094485	04-11/13		 2.8 MB





Catalogs

- ▼ Electronic-Key-System EKS Electronic-Key-System EKS Electronic-Key-System EKS Electronic-Key-System EKS



	Doc. no.	Version	Language	Download
Electronic-Key-System EKS	086808	14-04/17		 3.2 MB
Electronic-Key-System EKS	092953	14-04/17		 3.2 MB
Electronic-Key-System EKS	114432	14-04/17		 3.2 MB
Electronic-Key-System EKS	086809	14-04/17		 3.2 MB

Application example



- ▼ Definition der Schlüsselstruktur auf einem EKS-Schlüssel

	Doc. no.	Version	Language	Download
Definition der Schlüsselstruktur auf einem EKS-Schlüssel	AP000169-1	02-09/15		 0.5 MB
Definition of the Electronic-Key structure on an EKS Key	AP000169-1	02-09/15		 0.4 MB





- ▼ EKS mit Datenschnittstelle: Weitergabe von Informationen an Maschinenbauer

	Doc. no.	Version	Language	Download
EKS mit Datenschnittstelle: Weitergabe von Informationen an Maschinenbauer	AP000169-6	02-09/15		 0.2 MB





- ▼ EUCHNER EKS FSA Research Report

	Doc. no.	Version	Language	Download
EUCHNER EKS FSA Research Report	AP000169-IFA	01-09/15		 0.3 MB

- ▼ Einrichten der EKM Software als Programmierplatz

	Doc. no.	Version	Language	Download
Einrichten der EKM Software als Programmierplatz	AP000169-2	02-09/15		 1.0 MB
Setting up the EKM software as a programming station	AP000169-2	02-09/15		 0.9 MB







- ▼ Übersicht über EKS-Applikationen

	Doc. no.	Version	Language	Download
Übersicht über EKS-Applikationen	AP000169	02-09/15		 0.5 MB
Overview of EKS applications	AP000169	02-09/15		 0.3 MB

Declaration of conformity

- ▼ EU-Konformitätserklärung

Doc. no.	Version	Language	Download
----------	---------	----------	----------

EU-Konformitätserklärung	2093140	07-01/17		 0.3 MB
Declaración UE de conformidad				
Déclaration UE de conformité				
Dichiarazione di conformità				
EU declaration of conformity				

CAD data

CAD data for this item on TraceParts