

ITEM 100401 EKS-A-IEX-G01-ST02/03

Description	Technical data	Accessories	Downloads
-------------	----------------	-------------	-----------

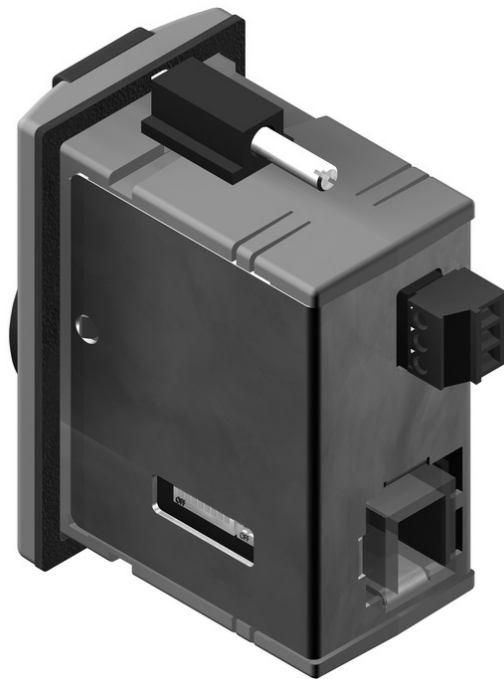

Features

- › Electronic-Key adapter with Ethernet TCP/IP interface
- › read/write system
- › Remote installation
- › Electronic-Key adapter and electronics in one housing
- › Reliable retention of the Electronic-Key, even if there is heavy vibration
- › Transfers the data from the Electronic-Key to a control system for processing
- › Connection to PC
- › Open communication commands at the lowest level
- › Interfacing to the user software via ActiveX[®] module in Windows[®] possible
- › Various options for address assignment, also using DIP switches

Approvals



Mechanical values and environment

Housing material	PA6-GF30 gray
Ambient temperature	0 ... 55 °C
Degree of protection	IP67 in installed state (only access side)
Mounting cut-out according to DIN 43700	33 x 68 mm
Installation position	On the front
	Industrial Ethernet
Connection	RJ-45 socket

Electrical connection ratings

LED indicator	Green	Operational
	Yellow	Key in operating distance
	Red	Fault
		Industrial Ethernet
Connecting cable		
		Min.2x2 twisted pair copper cable shielded, min. Cat. 5
		Star topology wiring
		Power supply
Operating voltage DC		20 ... 24 ... 28 V DC
Current consumption		max.150 mA

Interface, bus

	Industrial Ethernet
Data protocol	TCP/IP
Data rate	10/100 Mbit/s
Data interface	Ethernet (IEEE 802.3)

Dimension drawing

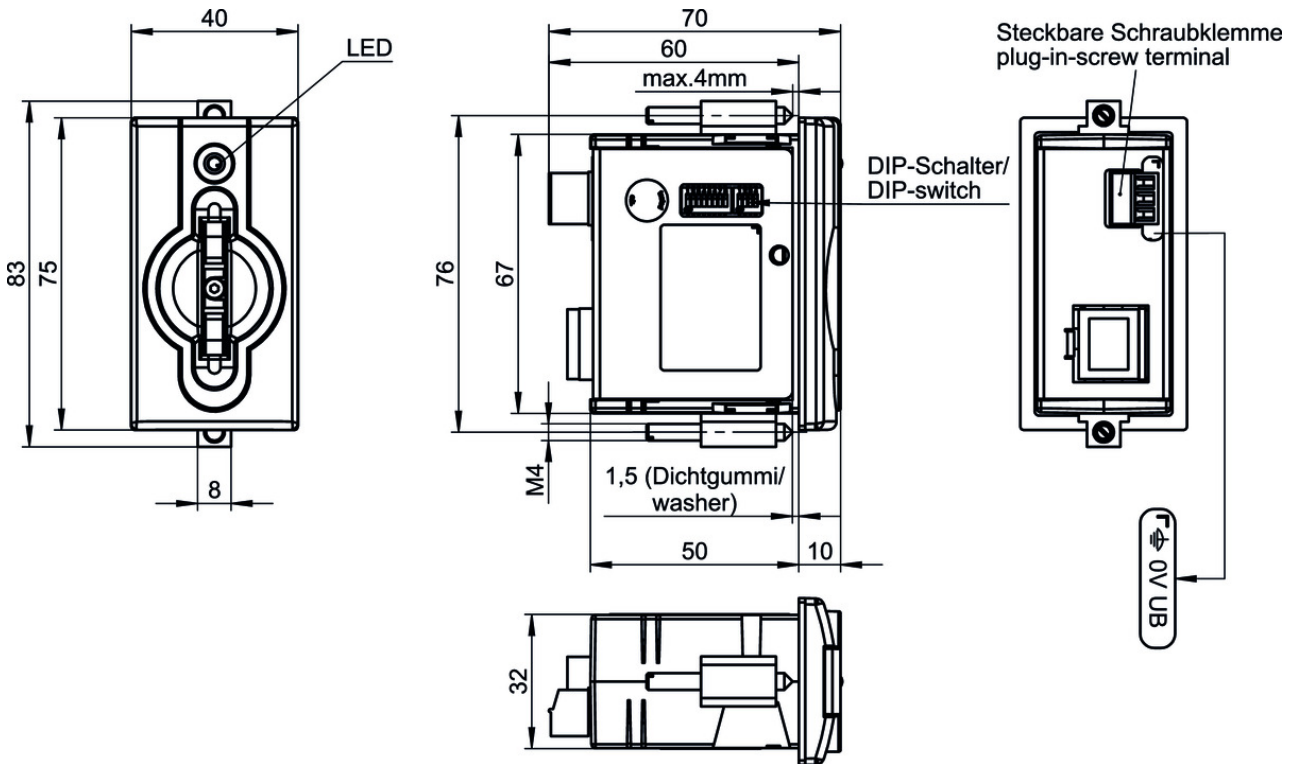

Block diagram

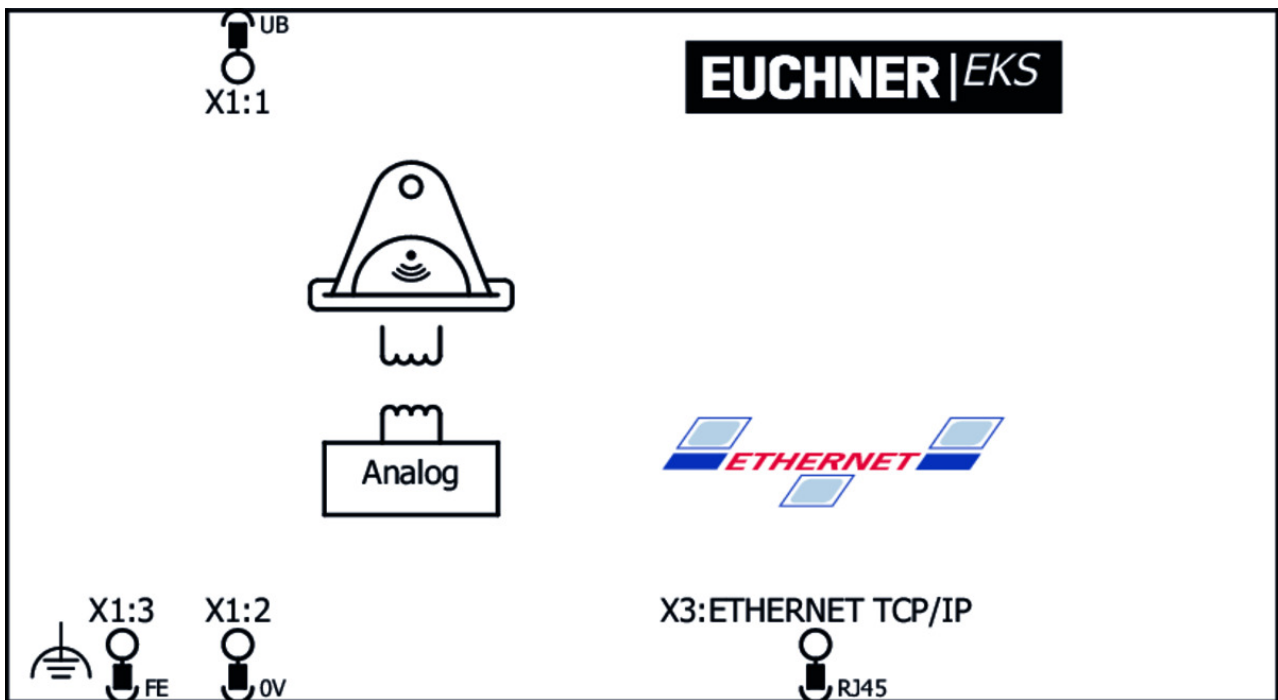

Electronic-Key

- ✓ Electronic-Key read/write



077859 EKS-A-K1RDWT32-EU

- ✓ Features

- › Memory 116 bytes E²PROM (programmable) plus 8 bytes ROM (serial)

number)



084735 EKS-A-K1BKWT32-EU

✓ Features

- › Memory 116 bytes E²PROM (programmable) plus 8 bytes ROM (serial number)



094840 EKS-A-K1YEWT32-EU

✓ Features

- › Memory 116 bytes E²PROM (programmable) plus 8 bytes ROM (serial number)



091045 EKS-A-K1BUWT32-EU

✓ Features

- › Memory 116 bytes E²PROM (programmable) plus 8 bytes ROM (serial number)



094839 EKS-A-K1GNWT32-EU

✓ Features

- › Memory 116 bytes E²PROM (programmable) plus 8 bytes ROM (serial number)



123097 EKS-A-K1WHWT32-EU

✓ Features

- › Memory 116 bytes E²PROM (programmable) plus 8 bytes ROM (serial number)



123098 EKS-A-K1OGWT32-EU

✓ Features

- › Memory 116 bytes E²PROM (programmable) plus 8 bytes ROM (serial number)

Software

✓ ActiveX® module - Ethernet TCP/IP communication







100665 ANWPG EKS ETH ACTIVEX-MODULE CD-ROM

✓ Features

- › Protocol driver software for integrating the EKS Electronic-Key adapters with Ethernet TCP/IP interface into a PC application in Windows







Instructions

✓ Handbuch EKS Schlüsselaufnahme Ethernet TCP/IP & Ethernet TCP/IP FSA

	Doc. no.	Version	Language	Download
Handbuch EKS Schlüsselaufnahme Ethernet TCP/IP & Ethernet TCP/IP FSA	100420	02-01/09		 1.5 MB
Manual EKS Electronic-Key Adapter Ethernet TCP/IP & Ethernet TCP/IP FSA	100420	02-01/09		 1.5 MB





Catalogs

- ▼ Electronic-Key-System EKS Electronic-Key-System EKS Electronic-Key-System EKS Electronic-Key-System EKS



	Doc. no.	Version	Language	Download
Electronic-Key-System EKS	086808	14-04/17		 3.2 MB
Electronic-Key-System EKS	092953	14-04/17		 3.2 MB
Electronic-Key-System EKS	114432	14-04/17		 3.2 MB
Electronic-Key-System EKS	086809	14-04/17		 3.2 MB

Application example

- ▼ Definition der Schlüsselstruktur auf einem EKS-Schlüssel

	Doc. no.	Version	Language	Download
Definition der Schlüsselstruktur auf einem EKS-Schlüssel	AP000169-1	02-09/15		 0.5 MB
Definition of the Electronic-Key structure on an EKS Key	AP000169-1	02-09/15		 0.4 MB





- ▼ EKS mit Datenschnittstelle: Weitergabe von Informationen an Maschinenbauer

	Doc. no.	Version	Language	Download
EKS mit Datenschnittstelle: Weitergabe von Informationen an Maschinenbauer	AP000169-6	02-09/15		 0.2 MB





- ▼ EUCHNER EKS FSA Research Report

	Doc. no.	Version	Language	Download
EUCHNER EKS FSA Research Report	AP000169-IFA	01-09/15		 0.3 MB

- ▼ Einrichten der EKM Software als Programmierplatz







	Doc. no.	Version	Language	Download
Einrichten der EKM Software als Programmierplatz	AP000169-2	02-09/15		 1.0 MB
Setting up the EKM software as a programming station	AP000169-2	02-09/15		 0.9 MB

- ▼ Übersicht über EKS-Applikationen

	Doc. no.	Version	Language	Download
Übersicht über EKS-Applikationen	AP000169	02-09/15		 0.5 MB
Overview of EKS applications	AP000169	02-09/15		 0.3 MB

Declaration of conformity

- ▼ EU-Konformitätserklärung

	Doc. no.	Version	Language	Download
EU-Konformitätserklärung	2093140	07-01/17		 0.3 MB
Declaración UE de conformidad				
Déclaration UE de conformité				
Dichiarazione di conformità				
EU declaration of conformity				

CAD data

CAD data for this item on TraceParts