

ITEM 083892 RIEGEL NZ-CB

Description	Technical data	Accessories	Downloads
-------------	----------------	-------------	-----------

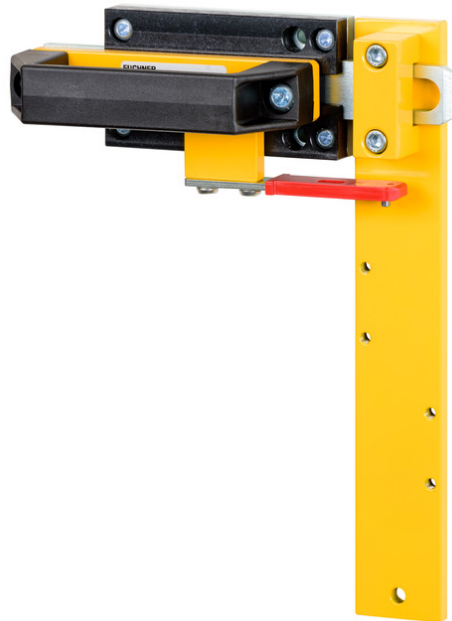

Features

- › Steel bolt
- › For doors hinged on the left
- › Ball detent mechanism in closed position
- › Can be locked in open position with padlocks
- › Actuator and switch bracket included

Advantages

- › Robust construction
- › Easily fitted to standard aluminum profiles and machine covers by screw connection
- › Distinctive yellow color for easy recognition
- › No additional door handle necessary

Special features

- › Bolt **NZ-B** latches in open and closed position
 - › Prevents accidental opening and closing of the bolt
- › Easy to use

Mechanical values and environment

Material		
	Handle	Plastic
	Guide strips	Plastic
	Base plate	Galvanized steel
	Switch bracket	Steel powder-coated
Weight		
	Net	1,75 kg
Escape release		No
Number of safety switches that can be fitted		1

Miscellaneous

Detent mechanism		
	Open position	Ball detent mechanism
	Closed position	Ball detent mechanism

Dimension drawing

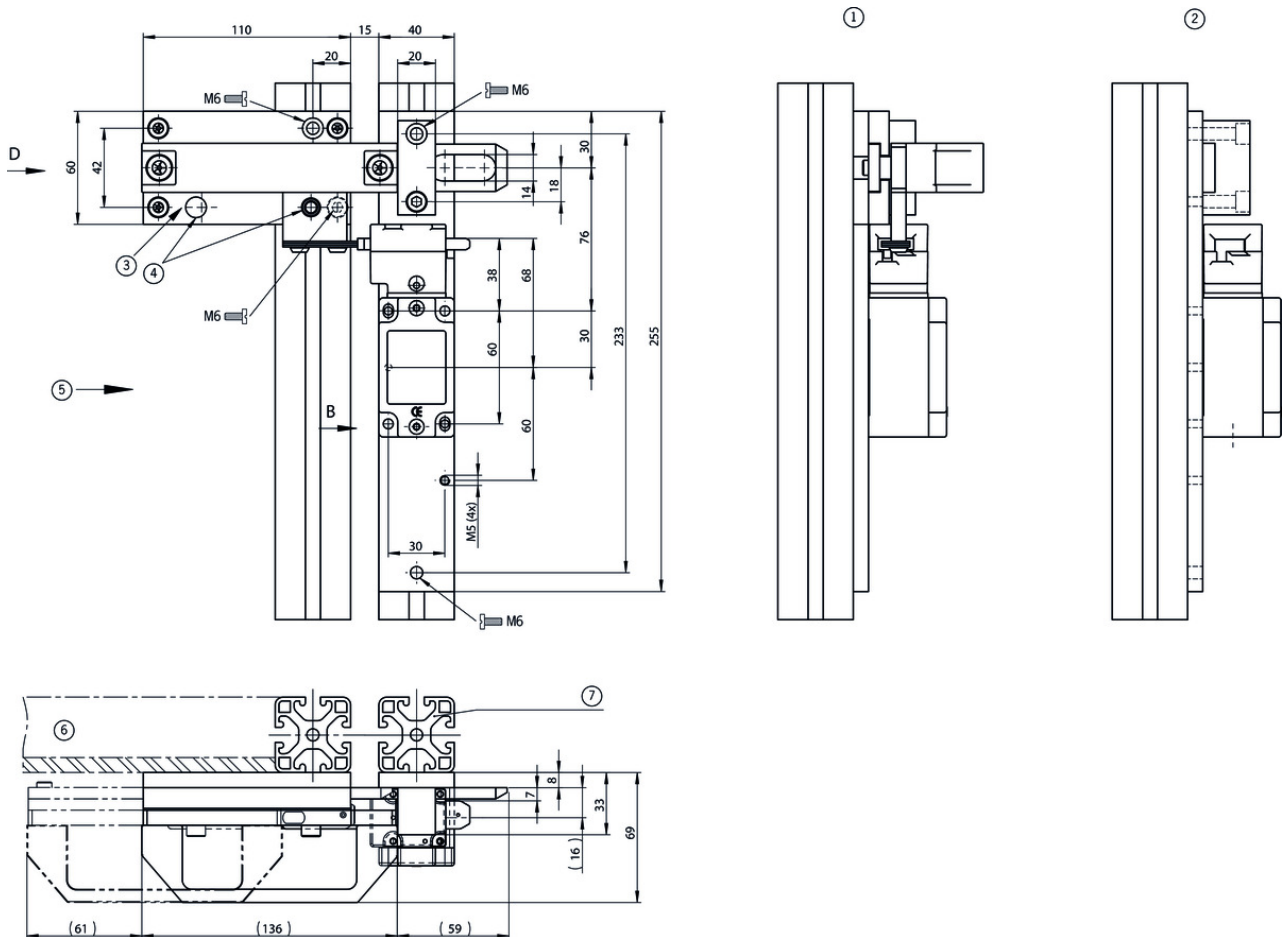

Legende

- 1 View D
- 2 View B
- 3 Attention! Bolt is not allowed to be used in conjunction with an escape release!
- 4 Detent mechanism against accidental opening/closing (vibration)
- 5 Safety switch NZ.VZ approach direction C
- 6 Door hinged on the left
- 7 Safety guard frame (40x40)

Spare parts

- Replacement handle for EUCHNER bolts















093500 RIEGELGRIFF/V5

Features

- › Material: plastic, reinforced polypropylene (PP)
- › Color: black, mat
- › Temperature resistance up to 100 °C
- › Packaging unit 5 pieces

Catalogs

- ▼ Sicherheitsschalter mit Metallgehäuse Safety Switches with Metal Housing Bezpečnostní spínače s kovovým pouzdem Interrupteurs de sécurité avec boîtier métallique 金属壳体 的安全开关 Interruptores de seguridad con carcasa metálica

	Doc. no.	Version	Language	Download
Sicherheitsschalter mit Metallgehäuse	100319	11-03/18		 7.9 MB
Interrupteurs de sécurité avec boîtier métallique	100676	11-03/18		 7.9 MB
Interruptores de seguridad con carcasa metálica	104856	11-03/18		 14.0 MB
Safety Switches with Metal Housing	100369	11-03/18		 7.9 MB
Bezpečnostní spínače s kovovým pouzdem	121650	11-03/18		 7.9 MB
金属壳体 的安全开关	102453	11-03/18		 8.2 MB

CAD data

CAD data for this item on TraceParts