

ITEM 088823 CIS3AP50X50SH16YSNOP

Description	Technical data	Accessories	Downloads
-------------	----------------	-------------	-----------



Features

- › Square design 50 x 50 mm
- › Unprogrammed or programmed

Programming

The data carrier can be written (programmed) for read-only operation with a maximum of 32 hexadecimal digits (value from 0_{hex} to F_{hex}) on customer request. Standard filler digit after the customer-specific defined digits is E_{hex}. The housing is permanently laser marked with the digits programmed (not including filler digits) in hexadecimal notation.

Approvals



Mechanical values and environment

Housing material	PPS plastic
Ambient temperature	-20 ... 85 °C
Degree of protection	IP67
Mounting method	Screws, surface mounting on metal
Method of operation	Operating frequency 125kHz

Electrical connection ratings

Power supply	Inductive via read head
Number of read cycles	max.unbegrenzt
Number of write cycles	max.100000
Storage capacity	16 B Read / write ^[1]
Data retention time	At +22°Cmax.20 y





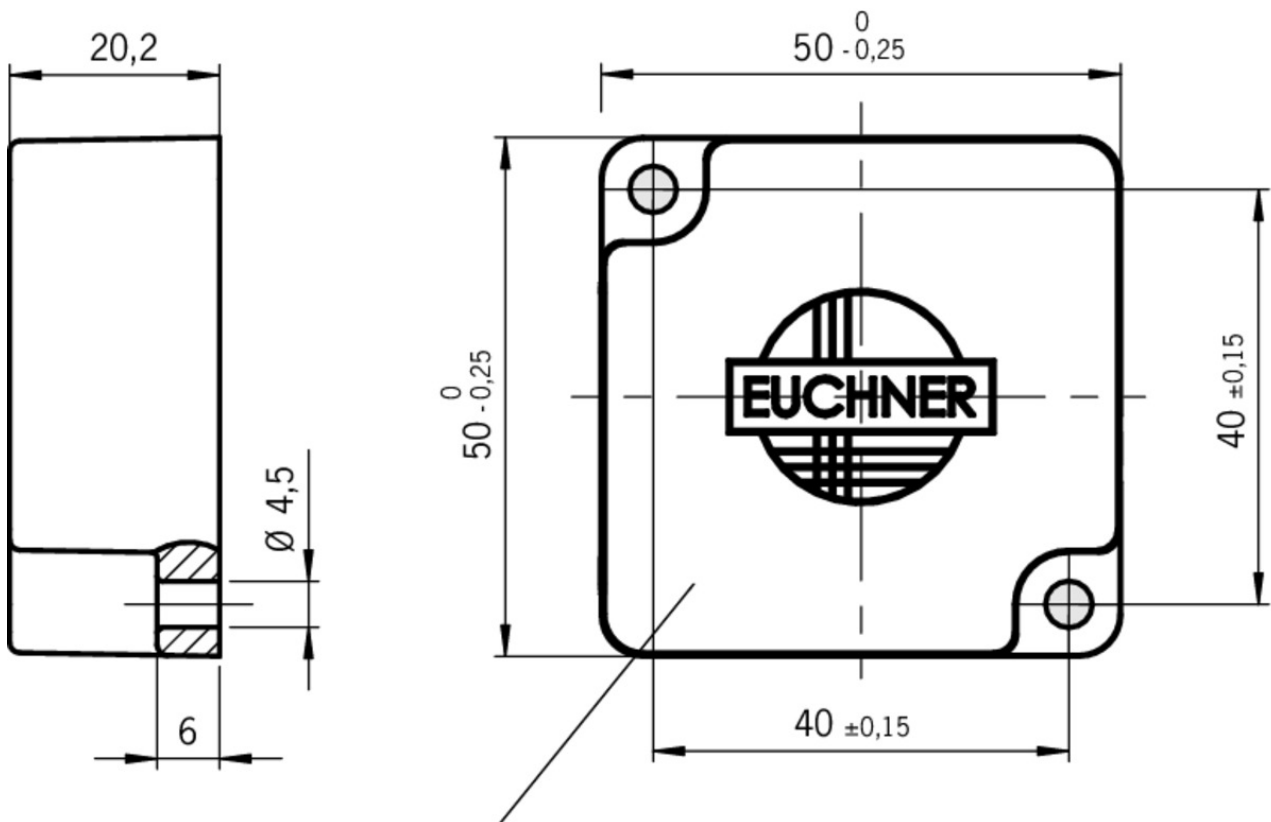

[1] The storage on the read/write data carrier is organized as follows: Write: only possible in 2-byte blocks Read: possible byte by byte

Dimension drawing



Catalogs

Identsystem CIS Identification System CIS Système d'identification CIS

	Doc. no.	Version	Language	Download
Identsystem CIS	076621	03-01/13		 5.6 MB
Système d'identification CIS	110763	03-01/13		 5.5 MB
Identification System CIS	076660	03-01/13		 5.5 MB